A digital cityscape background composed of blue dots and lines, resembling a data visualization or a stylized city skyline.

Technical Assistance for the Connection Network Codes Implementation in the Energy Community

MOLDOVA

Electricity Coordinating Center Ltd.
June 2021

Electricity



- Final -

Beneficiary:



Energy Community Secretariat

Am Hof 4, Level 5-6, 1010 Vienna, Austria

Consultant:



Electricity Coordinating Center Ltd.

Vojvode Stepe 412, PO Box 50, 11040 Belgrade, Serbia

Team:

Project manager: **Nebojša Jović**

Authors: Djordje Dobrijevic

Milan Stojanovic

Bogdan Lutovac

Contents

REPORT ON IDENTIFIED CONNECTION TECHNICAL REQUIREMENTS TO BE SET ON NATIONAL LEVEL (NON-EXHAUSTIVE REQUIREMENTS) AND GAP ANALYSIS REGARDING PRESENT TRANSPOSITION OF NON-EXHAUSTIVE REQUIREMENTS IN BENEFICIARY COUNTRIES NATIONAL LEGISLATION

List of Abbreviations.....	i
Definitions	i
1. Introduction.....	1
2. Non-Exhaustive parameters.....	3
2.1. RfG Non-Exhaustive Requirements	6
2.1.1. Determination of significance	6
2.1.2. Frequency Issues	7
2.1.3. Voltage Issues.....	21
2.1.4. System Restoration Issues.....	35
2.1.5. Instrumentation, Simulation Models and Protections Issues	41
2.2. DCC Non-Exhaustive Requirements	45
2.2.1. Frequency Issues	45
2.2.2. Voltage Issues.....	51
2.2.3. System Restoration Issues.....	57
2.2.4. Instrumentation, Simulation Models and Protections Issues	62
3. Gap analysis.....	65
3.1. Electricity power system general overview.....	65
3.2. Grid Codes - Current state of affairs.....	66
3.3. Gap analysis.....	66
3.3.1. RfG Non-Exhaustive Requirements	67
3.3.2. DCC Non-Exhaustive Requirements	68
4. References.....	69
Appendix 1.....	72

SETTING OF METHODOLOGIES FOR DETERMINATION OF NON-EXHAUSTIVE REQUIREMENTS

List of Abbreviations.....	i
Definitions	i
1. Introduction.....	1
2. Methodology for RfG Non-Exhaustive Requirements.....	3
2.1. Determination of significance	3
2.2. Frequency Issues	8

2.2.1.	Frequency Ranges	8
2.2.2.	Rate-of-Change-of-Frequency	11
2.2.3.	Frequency Sensitive Mode	15
2.2.4.	Limited Frequency Sensitivity Mode - Overfrequency	20
2.2.5.	Limited Frequency Sensitivity Mode - Underfrequency.....	23
2.2.6.	Admissible Active Power Reduction.....	25
2.2.7.	Logic Interface and automatic connection to the network.....	27
2.2.8.	Frequency Stability	29
2.2.9.	Frequency Restoration Control	30
2.2.10.	Real-Time Monitoring of FSM	31
2.2.11.	Rates of Change of Active Power Output.....	33
2.3.	Voltage Issues.....	34
2.3.1.	Voltage Ranges	34
2.3.2.	Fault ride through capability	39
2.3.3.	Automatic Disconnection due to Voltage Level	47
2.3.4.	Reactive Power Capability	48
2.3.5.	Reactive Power Capability below maximum power.....	57
2.3.6.	Fast fault current capability.....	66
2.4.	System Restoration Issues.....	69
2.4.1.	Reconnection Capability.....	69
2.4.2.	Blackstart Capability	70
2.4.3.	Capability of Island Operation	72
2.4.4.	Operation following Tripping to Houseload.....	74
2.4.5.	Active Power Recovery SPGM	75
2.4.6.	Post Fault Active Power Recovery PPM	75
2.5.	Instrumentation, Simulation Models and Protections Issues	77
2.5.1.	Control and Protection Scheme and Settings	77
2.5.2.	Instrumentation	79
2.5.3.	Simulation models.....	81
2.5.4.	Information exchange	83
2.5.5.	Disconnection from grid caused by angular instability or loss of control	84
2.5.6.	Additional devices to be installed in power generating facility in order to preserve or restore system operation or security	84
2.5.7.	Step up transformer HV side neutral point earthing type	85
2.5.8.	Synchronization device.....	86
2.5.9.	Angular stability.....	87
2.5.10.	Synthetic inertia	87
3.	Methodology for DCC Non-Exhaustive Requirements.....	93
3.1.	Frequency Issues	93
3.1.1.	Frequency Ranges	93

3.1.2.	Rate of Change of Frequency	94
3.1.3.	Demand Response System Frequency Control	95
3.2.	Voltage Issues	98
3.2.1.	Voltage Ranges	98
3.2.2.	Automatic Disconnection Due to Voltage Level	99
3.2.3.	Reactive power capability for TC DF and TC DS	100
3.2.4.	Demand Response Service (DRS).....	103
3.2.5.	Power Quality	105
3.3.	System Restoration Issues.....	106
3.3.1.	Short circuit requirements	106
3.3.2.	Demand Disconnection for System Defence.....	108
3.4.	Instrumentation, Simulation Models and Protections Issues	117
3.4.1.	Electrical Protection Scheme and Settings.....	117
3.4.2.	Control Requirements	118
3.4.3.	Information Exchanges.....	118
3.4.4.	Simulation Models.....	119
4.	References.....	121
5.	Appendix 1.....	123
6.	Appendix 2.....	125
7.	Appendix 3.....	127
8.	Appendix.....	135
8.1.	ENTSO-e practice for requirements applicable to type B PGMs	135
8.2.	ENTSO-e practice for requirements applicable to type C & D SPGMs	137
8.3.	ENTSO-e practice for requirements applicable to type C & D PPMs.....	142
9.	Appendix 5.....	144

DRAFTING OF PROVISIONS

List of Abbreviations.....	i
Definitions	i
1. Introduction.....	1
2. Provision of RfG Non-Exhaustive Requirements.....	3
2.1. Frequency Issues	3
2.1.1. Frequency Ranges	3
2.1.2. Rate-of-Change-of-Frequency	4
2.1.3. Frequency Sensitive Mode	5
2.1.4. Limited Frequency Sensitivity Mode - Overfrequency.....	6
2.1.5. Limited Frequency Sensitivity Mode - Underfrequency.....	7
2.1.6. Admissible Active Power Reduction.....	8
2.1.7. Logic Interface and automatic connection to the network.....	8

2.1.8.	Frequency Stability	10
2.1.9.	Frequency Restoration Control	10
2.1.10.	Real-Time Monitoring of FSM	11
2.1.11.	Rates of Change of Active Power Output.....	11
2.2.	Voltage Issues.....	13
2.2.1.	Voltage Ranges	13
2.2.2.	Fault ride through capability	14
2.2.3.	Automatic Disconnection due to Voltage Level	17
2.2.4.	Reactive Power Capability.....	18
2.2.5.	Reactive Power Capability below maximum power.....	20
2.2.6.	Voltage/Reactive Power Control.....	20
2.2.7.	Fast fault current capability.....	22
2.2.8.	Fast fault current capability.....	23
2.3.	System Restoration Issues.....	24
2.3.1.	Reconnection Capability.....	24
2.3.2.	Blackstart Capability	25
2.3.3.	Capability of Island Operation.....	26
2.3.4.	Operation following Tripping to Houseload.....	27
2.3.5.	Active Power Recovery SPGM	28
2.3.6.	Post Fault Active Power Recovery PPM	28
2.4.	Instrumentation, Simulation Models and Protections Issues	29
2.4.1.	Control and Protection Scheme and Settings	29
2.4.2.	Instrumentation	29
2.4.3.	Simulation models.....	30
2.4.4.	Information exchange	30
2.4.5.	Disconnection from grid caused by angular instability or loss of control.....	30
2.4.6.	Additional devices to be installed in power generating facility in order to preserve or restore system operation or security.....	31
2.4.7.	Step up transformer HV side neutral point earthing type	31
2.4.8.	Synchronization device.....	31
2.4.9.	Angular stability.....	32
2.4.10.	Synthetic inertia	32
3.	Provisions of DCC Non-Exhaustive Requirements.....	33
3.1.	Frequency Issues	33
3.1.1.	Frequency Ranges	33
3.1.2.	Rate of Change of Frequency	33
3.1.3.	Demand Response System Frequency Control	34
3.2.	Voltage Issues.....	35
3.2.1.	Voltage Ranges	35
3.2.2.	Automatic Disconnection Due to Voltage Level.....	36

3.2.3.	Reactive power capability for TC DF and TC DS	36
3.2.4.	Demand Response Service (DRS).....	38
3.2.5.	Power Quality	38
3.3.	System Restoration Issues	40
3.3.1.	Short circuit requirements	40
3.3.2.	Demand Disconnection for System Defence.....	42
3.4.	Instrumentation, Simulation Models and Protections Issues	46
3.4.1.	Electrical Protection Scheme and Settings	46
3.4.2.	Control Requirements	46
3.4.3.	Information Exchanges	46
3.4.4.	Simulation Models.....	49
4.	References.....	50

MUTUAL TSO AND DSO CONNECTION ISSUES AND BUSINESS PROCESSES

List of Abbreviations.....	i
Definitions	i
1. Introduction.....	1
2. Processes	2
2.1. Determination of significance	2
2.2. Implementation of non-exhaustive parameters	1
2.2.1. DSO and TSO coordination during the implementation process of non-exhaustive parameters	1
2.3. Technical conditions for connection	1
2.4. Derogation process	1
2.5. Compliance process.....	1
2.6. Process of changing and administration Grid Codes.....	3
3. Mutual TSO and DSO connection issues and business processes within RfG	4
3.1. Frequency Issues	4
3.2. Voltage Issues.....	6
3.2.1. Automatic Disconnection due to Voltage Level	6
3.2.2. Reactive Power Capability	7
3.2.3. Reactive Power Capability below maximum power.....	9
3.2.4. Voltage/Reactive Power Control	10
3.3. System Restoration Issues.....	11
3.4. Instrumentation, Simulation Models and Protections Issues	13
3.4.1. Control and Protection Scheme and Settings	13
3.4.2. Instrumentation	13
3.4.3. Simulation models.....	14
3.4.4. Information exchange	15
3.4.5. Disconnection from grid caused by angular instability or loss of control.....	16

4.	Mutual TSO and DSO connection issues and business processes within DCC	17
4.1.	Frequency Issues	17
4.1.1.	Frequency Ranges	17
4.2.	Voltage Issues.....	18
4.2.1.	Automatic Disconnection Due to Voltage Level.....	18
4.2.2.	Reactive power capability for TC DF and TC DS	18
4.3.	System Restoration Issues.....	20
4.3.1.	Demand Disconnection for System Defence.....	20
4.4.	Instrumentation, Simulation Models and Protections Issues	22
4.4.1.	Electrical Protection Scheme and Settings and Control Requirements	22
5.	References.....	23

**REPORT ON IDENTIFIED CONNECTION
TECHNICAL REQUIREMENTS TO BE SET ON
NATIONAL LEVEL (NON-EXHAUSTIVE
REQUIREMENTS) AND GAP ANALYSIS
REGARDING PRESENT TRANSPOSITION OF
NON-EXHAUSTIVE REQUIREMENTS IN
BENEFICIARY COUNTRIES NATIONAL
LEGISLATION**

List of Abbreviations

AGC	- Automatic Governor Control
APC	- Active Power Control
AVR	- Automatic Voltage Regulator
CCGT	- Combined Cycle Gas Turbine
CDS	- Closed Distribution System
CDSO	- Closed Distribution System Operator
CNC	- Connection Network Codes
DCC	- Demand Connection Code
DF	- Demand Facility
DR	- Demand Response
DRS	- Demand Response Service
DR SFC	- Demand Response System Frequency Control
DS	- Distribution System
DSO	- Distribution System Operator
DU	- Demand Unit
EnC	- Energy Community
ENTSO-E	- European Network of Transmission System Operators for Electricity
EU	- European Union
FRT	- Fault Ride Through
FSM	- Frequency Sensitivity Mode
HVDC	- High Voltage Direct Current
IGD	- Implementation Guidance Document
LFDD	- Low Frequency Demand Disconnection
LFSM	- Limited Frequency Sensitivity Mode
LFSM -O	- Limited Frequency Sensitivity Mode - Overfrequency
LFSM -U	- Limited Frequency Sensitivity Mode - Underfrequency
NC	- Network Codes
NRA	- National Regulatory Authority
PE	- Power electronics
PGFO	- Power Generating Facility Owner
PGM	- Power Generating Module
PHLG	- Permanent High Level Group
PPM	- Power Park Module
PSS	- Power System Stabilizer
RES	- Renewable Energy Sources

RfG	- Requirements for Generators
RoCoF	- Rate-of-Change-of-Frequency
RPC	- Reactive Power Control
RSO	- Relevant System Operator
SPGM	- Synchronous Power-Generating Module
SFC	- System Frequency Control
SPGM	- Synchronous Power-Generating Module
TC DF	- Transmission connected Demand Facility
TC DS	- Transmission Connected Distribution System, including Transmission Connected Distribution Facilities
TS	- Transmission System
TSO	- Transmission System Operator

Definitions

Closed Distribution System	a distribution system classified as a closed distribution system by national regulatory authorities or by other competent authorities, where so provided by the EnC contracting party, which distributes electricity within a geographically confined industrial, commercial or shared services site and does not supply household customers, without prejudice to incidental use by a small number of households located within the area served by the system and with employment or similar associations with the owner of the system;
Connection point	the interface at which the PGM, demand facility, distribution system or HVDC system is connected to a transmission system, offshore network, distribution system, including closed distribution systems, or HVDC system, as identified in the connection agreement;
Demand facility	a facility which consumes electrical energy and is connected at one or more connection points to the transmission or distribution system. A distribution system and/or auxiliary supplies of a power generating module do not constitute a demand facility;
Demand unit	an indivisible set of installations containing equipment which can be actively controlled by a demand facility owner or by a CDSO, either individually or commonly as part of demand aggregation through a third party;
Grid User	assets/facilities and their owners connected to transmission or distribution networks;
Low Frequency Demand Disconnection	an action where demand is disconnected during a low frequency event in order to recover the balance between demand and generation and restore system frequency to acceptable limits;
Maximum capacity	the maximum continuous active power which a PGM can produce, less any demand associated solely with facilitating the operation of the PGM and not fed into the network as specified in the connection agreement or as agreed between the relevant system operator and the PGFO (usually noted as Pmax);
Maximum Export Capability	the maximum continuous active power that a transmission-connected demand facility or a transmission-connected distribution facility, can feed into the network at the connection point, as specified in the connection agreement or as agreed between the relevant system operator and the transmission-connected demand facility owner or transmission-connected distribution system operator respectively;
Maximum Import Capability	the maximum continuous active power that a transmission-connected demand facility or a transmission-connected distribution facility can consume from the network at the connection point, as specified in the connection agreement or as agreed between the relevant system operator and the transmission-connected demand facility owner or transmission-connected distribution system operator respectively;

Power-generating facility	a facility that converts primary energy into electrical energy and which consists of one or more PGMs connected to a network at one or more connection points;
Power-generating facility owner	a natural or legal entity owning a power-generating facility;
Power-generating module	either a synchronous power-generating module or a power park module;
Power park module	a unit or ensemble of units generating electricity, which is either non-synchronously connected to the network or connected through power electronics, and that also has a single connection point to a transmission system, distribution system including closed distribution system or HVDC system
Proposer	an entity which determines value/range/specification of technical requirement;
Relevant system operator	the TSO or DSO to whose system a PGM, demand facility, distribution system or HVDC system is or will be connected;
Relevant TSO	the TSO in whose control area a PGM, a demand facility, a distribution system or a HVDC system is or will be connected to the network at any voltage level;
Synchronous power-generating module	means an indivisible set of installations which can generate electrical energy such that the frequency of the generated voltage, the generator speed and the frequency of network voltage are in a constant ratio and thus in synchronism;
Synthetic inertia	the facility provided by a PPM or HVDC system to replace the effect of inertia of a SPGM to a prescribed level of performance;
Transmission-connected Demand Facility	a demand facility which has a connection point to a transmission system;
Transmission-Connected Distribution Facility	a distribution system connection or the electrical plant and equipment used at the connection to the transmission system;
Transmission-Connected Distribution System	a distribution system connected to a transmission system, including transmission-connected distribution facilities;

1. Introduction

Since 2011, significant efforts have been made in the development of network codes and guidelines for electricity by the European Commission (Network Codes), the Agency for the Cooperation of Energy Regulators (ACER), the European Network of Transmission System Operators for Electricity (ENTSO-E), the Association representing distribution system operators (DSOs), the European Energy Exchange Association (Europex) and other stakeholders, such as associations of consumers, producers, suppliers and other stakeholders in the electricity sector.

In addition, in accordance with Directive 2009/72 adopted by the European Commission and Regulation 714/2009, a decision was adopted for the formation of Network Codes and their implementation on the national level.

The Energy Community is an international organisation, which brings together the European Union and its neighbours to create an integrated pan-European energy market. The organisation was founded by the Treaty establishing the Energy Community signed in October 2005 in Athens, Greece, in force since July 2006. The key objective of the Energy Community is to extend the EU internal energy market rules and principles to countries in South East Europe, the Black Sea region and beyond on the basis of a legally binding framework.

Presently the Energy Community has nine Contracting Parties - Albania, Bosnia and Herzegovina, Kosovo*, North Macedonia, Georgia, Moldova, Montenegro, Serbia and Ukraine.

Decisions of the Permanent High Level Group no. 2018/03 and no. 2018/05 from 12 January 2018, in Article 1, items 1 and 2 defines the obligation for all Contracting Parties to transpose Regulation EU 2016/631 (Network Code on Requirements for grid connection of generators – NC RfG) and Regulation EU 2016/1388 (Network Code on demand connection – NC DC) without changing the structure and text, except for translation and adaptations made by the said Decisions.

Implementation of Network Codes into national regulations represents a significant challenge for system operators (both TSOs and DSOs), as they require the implementation of number of activities such as national decisions, amendments to existing legislation, conclusion of regional agreements and justification for defining specific technical requirements, as well as their coordinated application in the power system. Implementation should be done through amendments to the law and the adoption of network codes in the form of a regulation, while the national grid codes must not conflict with Network Codes.

Therefore, the national grid codes, after the adoption of network codes in EnC Contracting Parties should not contain the provisions i.e. parts of the network codes, except for the implementation of so-called non-exhaustive parameters.

The non-exhaustive parameters do not contain all the information or strict definition of parameters necessary to apply the requirements immediately and require system operators to determine their values, which may call for regional coordination between TSOs and coordination between TSO and DSO on the national level.

This project aims to provide technical assistance to EnC Contracting Parties in the process of connection network code implementation. This process requires development of new national grid codes, by updating existing ones in the field of connection of power generating facilities, distribution system and industrial consumers. In achieving this goal, one of the most important results is the

development of a methodology for assessing and determining values for technical non-exhaustive parameters from the Network Codes that take into account the specifics of the power system of each EnC member country and provides a balance between the required level of security, economic viability and incentive environment for investments in the power sector.

This report comprises following chapters and sections:

- **Section 1 – Introduction**
- **Section 2 – Non-exhaustive parameters**
This section gives an overview of all non-exhaustive parameters given in the NC RfG and NC DC
- **Section 3 – Gap analysis**
This section reviews the current status of national legislation related to definition of non-exhaustive parameters
- **Section 4 - References**
This section summarises the list of documents used in the preparation of this report
- **Section 5 – Annexes**

2. Non-Exhaustive parameters

At EU level connection code requirements for connection of generating units, requirements for demand connection, and requirements for connections of HVDC facilities are put into force by regulation [1], [2] and [3] respectively. After the PHLG decisions [4], [5] and [6] obligations for transposition and implementation of before mentioned CNC at EnC level were established with defined transposition and implementation deadlines. As stated in [4], [5] and [6] transposition of CNC shall be made without changes to the structure and text other than translation and the adaptations made by the PHLG decisions themselves.

Some of the requirements set in regulation [1], [2] and [3] are clearly defined, i.e. requirements contain all the information and/or parameters necessary to apply the requirements immediately, i.e. there is no need for further specification at national level. These requirements are called exhaustive requirements. Having in mind provisions given in [4], [5] and [6] regarding transpositions of the EU regulation these exhaustive requirements shall be immediately implemented at national level of EnC countries, with adaptations made by the PHLG decisions themselves. On the other hand, some of the topics and requirements given at CNCs do not contain all the information or parameters necessary to apply them immediately, i.e. there is a need for further specification of requirements at national level. These requirements are called non-exhaustive parameters. The non-exhaustive parameters given in regulation [1] and [2] are the main focus of this project.

Some of the requirements (see Figure 1) given in regulation [1] and [2] can be declared mandatory, and others can be declared non-mandatory. This means that the country implementing CNC shall implement the requirement rendered mandatory. On the other hand, for the non-mandatory requirements each of the country shall decide whether to implement the requirement. It should be noted that some of the non-mandatory CNC requirements could be made mandatory at national level.

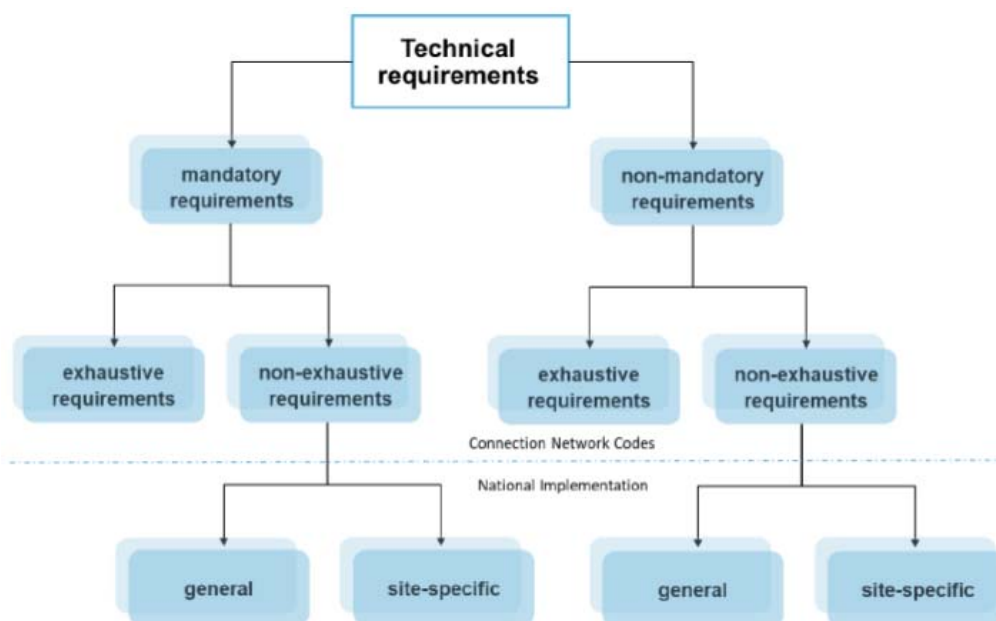

Figure 1 - Connection code technical requirements [7]

Some of the requirements could also be considered general and other site specific. According to the regulation [1] and [2] RSO or TSO shall establish requirements of general application. The requirements of general application, or the methodology used to calculate or establish them shall be approved by NRA (or some other national entity if provided by the EnC contracting party).

To support the implementation process at national level ENTSO-E have published set of guidelines covering the most significant aspects of non-exhaustive parameters implementations. These documents shall be used as the basis for the identification of the non-exhaustive parameters at national level of the beneficiaries. All of the recommendation given in these documents should be considered to be best practice, but it should be noted that IGDs are not binding in any way at the national level either by beneficiaries, NRAs, system operators and other relevant stakeholders.

Some of the requirements that are interdependent could be found in both regulation [1] and [2], and some of them should be considered together. As pointed out in [7] the crucial role in guaranteeing consistency between interdependent requirements at national level rests on NRAs, because in most of the cases they have monitoring/approval role in national connection code adaptation.

The Figure 1 should help better visualize technical requirements categorization.

All of the analysed non-exhaustive requirements (mandatory and non-mandatory) shall be clustered in 4 major categories as recommended in [7]:

1. Frequency Issues
2. Voltage Issues
3. System Restoration Issues
4. Instrumentation, Simulation Models and Protections Issues

Starting point for setting connection requirements and later for their implementation is determination of scope of significance through classification of power generating modules in 4 groups i.e. 4 types: type A, type B, type C and type D. These 4 types cover all of the power generating modules, from ones with small installed capacity connected to distribution network to the largest power plants connected to transmission system of the highest voltage levels. This classification is done according to installed capacity and nominal voltage of network to which the unit is being connected. RfG defines maximum threshold levels for classification of power generating modules depending mainly on installed capacity as non-exhaustive requirement (for detail information about this requirement see section 2.1.1). However it is up to each individual contracting party to implement this requirement and define adequate threshold values, applicable to their power system. Determination of threshold values for type A, B, C and D power generating modules will depend on several criteria, but most significant factors are: national generation portfolio (both present and future), expected penetration of RES and transition from bulk large capacity generating units connected to transmission system to large number of distributed generating units with smaller installed capacity, maintaining system security and applicability of certain RfG requirements to type A, B, C and D of power generating units. Guidelines for determination of these thresholds will be given in more details in methodology, after the completion of Task 3.

For efficient and effective implementation of RfG and DCC non-exhaustive requirements close cooperation between TSO and DSO will be needed. For example, RfG's requirements regarding frequency issues will require close cooperation between TSO and DSO, because power system frequency control is outside the scope of responsibility of DSO. Therefore for a lot of frequency related requirements ENTSO-E guidelines (e.g. [7]) recognizes that these requirements are going to be determined by TSO and implemented in distribution grid code by the DSO. At the moment, it might seem overwhelming to expect even from generating units with smaller capacity (connected to the distribution network) to satisfy same requirements as units with bigger installed capacity (dominantly connected to transmission system). However as paradigm shifts, and as we see transition from large coal power TPPs to distributed generation sources with smaller capacity (dominantly RES production units), it is of paramount importance not to jeopardize overall system security. DSO that will be mainly responsible for setting connection requirements for these distributed generating resources therefore needs to cooperate with TSO in order to harmonize connection requirements with TSO. This is not limited only to frequency related issues. In case of the countries having trouble with voltage regulation

possibility to have coordinated action between TSO and DSO regarding voltage control and reactive power management at the point of transmission and distribution system connection is also an important issue. Usual approach is that TSO and DSO have separate areas of responsibilities, regarding voltage control. In that regard TSO defines maximum reactive power (i.e. minimum power factor) that DSO must not generate/consume at connection point. In order to achieve this requirement many DSOs are coerced to invest in compensation of reactive power near consumers, mostly because excessive reactive power consumption at the connection point is penalized. However DCC allows for TSO and DSO to act together and find best scenario regarding voltage/reactive power control for the entire power system both distribution and transmission. In this way more efficient exploitation of resources, lower overall costs (both operational and investment) and better voltage quality could be achieved. This example are not the only areas that require close coordination and cooperation between TSO and DSO, and this project will particular emphasize those issues that require close cooperation between TSOs and DSOs.

In part 2 and 3 of this document non-exhaustive requirements from [1] and [2], respectively, clustered in the four before mentioned groups shall be listed and described. Where applicable possible range of parameter will be provided, and where not applicable brief proposition for parameter determination shall be provided. In following sections requirement parameters that are given in bold, are the ones needs to be set by the TSO/DSO. In depth proposition for parameter determination methodology shall be given after Task 3 completion.

2.1. RfG Non-Exhaustive Requirements

2.1.1. Determination of significance

Requirement	Thresholds for type B, C and D PGMs																
Network Code	RfG, Article 5																
Description	As stated in RfG PGMs shall comply with the requirements based on the voltage level of their connection point and their maximum capacity. Based on connection point voltage level and maximum capacity PGMs shall be qualified as type A, B, C or D PGM.																
Parameter(s)/ Range(s) & value(s)	<p>Parameters to be determined are maximum capacity thresholds for type A, B, C and D PGMs, with following limitations:</p> <ul style="list-style-type: none"> A. PGMs connected below 110 kV with maximum capacity of 0.8 kW or more B. PGMs connected below 110 kV with maximum capacity at or above a threshold proposed by each relevant TSO C. PGMs connected below 110 kV with maximum capacity higher than in the case of type B PGMs (type C). D. PGMs connected at 110 kV or above, and PGMs connected below 110 kV with maximum capacity equal or greater than a threshold for type C. <p>Limits for maximum capacity thresholds from which a PGM is of type B, C, D are defined in following table.</p> <table border="1"> <thead> <tr> <th>Synchronous areas</th> <th>Type B</th> <th>Type C</th> <th>Type D</th> </tr> </thead> <tbody> <tr> <td>Continental Europe, Ukraine</td> <td>1 MW</td> <td>50 MW</td> <td>75 MW</td> </tr> <tr> <td>Georgia</td> <td>1.5 MW</td> <td>10 MW</td> <td>30 MW</td> </tr> <tr> <td>Moldova</td> <td>0.5 MW</td> <td>10 MW</td> <td>15 MW</td> </tr> </tbody> </table> <p>(data source: [1] Table 1 Limits for thresholds for type B, C and D power-generating modules, and [4])</p>	Synchronous areas	Type B	Type C	Type D	Continental Europe, Ukraine	1 MW	50 MW	75 MW	Georgia	1.5 MW	10 MW	30 MW	Moldova	0.5 MW	10 MW	15 MW
Synchronous areas	Type B	Type C	Type D														
Continental Europe, Ukraine	1 MW	50 MW	75 MW														
Georgia	1.5 MW	10 MW	30 MW														
Moldova	0.5 MW	10 MW	15 MW														
Applicability	Type B, C and D PGMs																
Influencing factors/ Approach for requirement determination	Proposals for maximum capacity threshold capacities are subject to approval by NRA (or where applicable EnC contracting party). These thresholds can be changed, but no sooner than 3 years after previous proposal. As stated in [13] the periodical review of set threshold can be motivated based on the evolution of the system due to reasons like increasing penetration of RES usually combined with a change from bulk generation by SPGMs at transmission level towards embedded generation at distribution level often connected through PE devices, or increased cross border reliance.																
Proposer	Relevant TSO																
Collaboration	<p>Relevant TSO should coordinate this activity with adjacent TSOs and DSOs, and conduct public consultation in a way defined by RfG Article 10.</p> <p>TSO-DSO coordination is especially important. Defined maximum thresholds will have impact on applicability of RfG requirements. Even though it might seem that there is not direct impact to other NC, applicability of requirements to PGMs connected to distribution system can have direct impact on DSO capabilities to fulfil requirements set in DCC regarding reactive power exchange at interface to transmission system, for example</p>																

2.1.2. Frequency Issues

Requirement	Frequency Ranges												
Network Code	RfG, Article 13(1)(a)(i), 13(1)(a)(ii)												
Description	<p>RfG defines requirement regarding time period for which PGMs shall be capable of remaining connected to the network and operate within defined frequency ranges. Part of the requirements are define as exhaustive and other as non-exhaustive, to be defined by each TSO according to the defined ranges.</p> <p>RSO in coordination with relevant TSO and the PGFO may agree on wider frequency ranges and/or longer times for operation or specific requirements for combined frequency and voltage deviations</p> <p>Time period for which PGMs shall be capable of remaining connected to the network and operate within defined frequency ranges.</p>												
Parameter(s)/ Range(s) & value(s)	<table border="1"> <thead> <tr> <th>Synchronous area</th> <th>Frequency range</th> <th>Time period for operation</th> </tr> </thead> <tbody> <tr> <td rowspan="4">Continental Europe</td> <td>47.5 Hz-48.5 Hz</td> <td>To be specified by each TSO, but not less than 30 minutes</td> </tr> <tr> <td>48.5 Hz-490 Hz</td> <td>To be specified by each TSO, but not less than the period for 47.5 Hz-48.5 Hz</td> </tr> <tr> <td>49.0 Hz-51.0 Hz</td> <td>Unlimited</td> </tr> <tr> <td>51.0 Hz-51.5 Hz</td> <td>30 minutes</td> </tr> </tbody> </table>	Synchronous area	Frequency range	Time period for operation	Continental Europe	47.5 Hz-48.5 Hz	To be specified by each TSO, but not less than 30 minutes	48.5 Hz-490 Hz	To be specified by each TSO, but not less than the period for 47.5 Hz-48.5 Hz	49.0 Hz-51.0 Hz	Unlimited	51.0 Hz-51.5 Hz	30 minutes
Synchronous area	Frequency range	Time period for operation											
Continental Europe	47.5 Hz-48.5 Hz	To be specified by each TSO, but not less than 30 minutes											
	48.5 Hz-490 Hz	To be specified by each TSO, but not less than the period for 47.5 Hz-48.5 Hz											
	49.0 Hz-51.0 Hz	Unlimited											
	51.0 Hz-51.5 Hz	30 minutes											
Applicability	<p>Wider frequency ranges and/or longer times for operation or specific requirements for combined frequency and voltage deviations could be agreed.</p> <p>Type A, B, C and D PGMs</p>												
Influencing factors/ Approach for requirement determination	<p>Time periods in which modules shall be capable to remain connected to the network and operate when the frequency is significantly lower than nominal will be defined considering the time required for TSO dispatchers to response in accidental situations but not longer than the technical limitations of PGM's equipment. When defining this requirement TSOs should take into account existing operational practices, and dispatch personnel response to frequency disturbance situations that have occurred in the past.</p> <p>Good starting point when determining wider frequency ranges and/or longer time periods is to analyse black start operation and U/f characteristic of PGMs providing black start ancillary services.</p>												
Proposer	TSO time period for ranges, and RSO wider frequency ranges and/or longer times.												
Collaboration	TSO defines this requirement, and in some cases DSO must implement it for the PGMs connecting to the DS, according to scope of applicability given in RfG. Regional cooperation between TSOs is important and necessary when defining this requirement.												

Requirement	Rate-of-Change-of-Frequency
Network Code	RfG, Article 13(1)(b)
Description	<p>RfG defines that relevant TSO shall specify RoCoF value up to which PGM shall be capable to stay connected to the network and operate.</p> <p>The RSO, in coordination with the relevant TSO, shall also specify RoCoF-type loss of mains protection.</p>
Parameter(s)/ Range(s) & value(s)	<p>Rate-of-Change-of-Frequency max value and measuring window for which PGM shall stay connected.</p> <p>RoCoF-type loss of mains protection.</p>
Applicability	Type A, B, C and D PGMs
Influencing factors/ Approach for requirement determination	<p>When defining Rate-of-Change-of-Frequency max value TSOs should take into account encountered RoCoF values during disturbance situations that have occurred in the past, and also system development plans concerning SPGM decommissioning dictated by the environmental protection requirements and different RES penetration scenarios (from conservative to scenarios with maximum RES penetration). During the disturbance situations that have occurred in the past, measuring window for measure RoCoF will be analysed.</p> <p>When determining RoCoF-type loss of mains protection, typical PGM control and protection schemes will be analysed. This parameter is connected to recognized island operation conditions. The consultant will request information from interested parties regarding the settings of these protections. If there is not enough data, the consultant will use his experience.</p>
Proposer	TSO propose RoCoF max value and RSO in coordination with the TSO propose RoCoF-type loss of mains protection.
Collaboration	TSO defines this requirement, and DSO must implement it for the PGMs connecting to the DS, according to scope of applicability given in RfG. Regional cooperation between TSOs is important and necessary when defining this requirement.

Requirement **Frequency Sensitive Mode (1 of 3)**

Network Code **RfG, Article 15(2)(d)**

According to RfG, PGM shall be capable of providing active power frequency response.

TSO shall take account of the following facts:

- in case of overfrequency, the active power frequency response is limited by the minimum regulating level,
- in case of underfrequency, the active power frequency response is limited by maximum capacity,
- the actual delivery of active power frequency response depends on the operating and ambient conditions of the PGM when this response is triggered, in particular limitations on operation near maximum capacity at low frequencies and available primary energy sources.

Description

In the event of a frequency step change, the PGM shall be capable of activating full active power frequency response, at or above the full line shown in Figure 3 in accordance with the parameters specified by each TSO (which shall aim at avoiding active power oscillations for PGM). The initial activation of active power frequency response required shall not be unduly delayed. If the delay in initial activation of active power frequency response is greater than 2 seconds, the PGFO should provide technical evidence demonstrating why a longer time is needed.

According to RfG, the PGM shall be capable of providing full active power frequency response for a period of between 15 and 30 minutes as specified by the relevant TSO

Parameters active power range related to maximum capacity, frequency response insensitivity, frequency response dead band and droop will be determined in accordance with the parameters specified by each relevant TSO within predefined ranges (Figure 2) and appropriate table (table below figure 2).

Parameter(s)/
Range(s) & value(s)

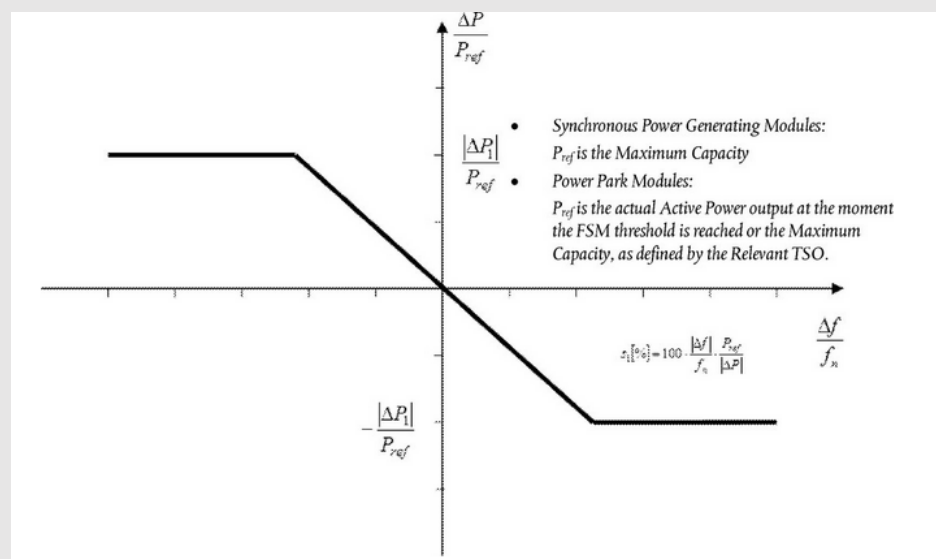

Figure 2 - Active power frequency response capability of power-generating modules in FSM illustrating the case of zero deadband and insensitivity ([1] Figure 5)

Requirement

Frequency Sensitive Mode (2 of 3)

Values of characteristic parameters applicable to Figure 2 are given in following table:

Parameters		Ranges
Active power range related to maximum capacity $\frac{ \Delta P_1 }{P_{max}}$		1.5-10%
Frequency response insensitivity	$ \Delta f_i $	10-30 mHz
	$ \Delta f_i /f_n$	0.02-0.06%
Frequency response deadband		0-500 mHz
Droop s_1		2-12%

Ranges for parameters: Maximum admissible full activation time, maximum admissible initial delay for PGMs without inertia and time period for the provision of full active power frequency response are predefined and illustrated on next figure and appropriate table (table below figure 3).

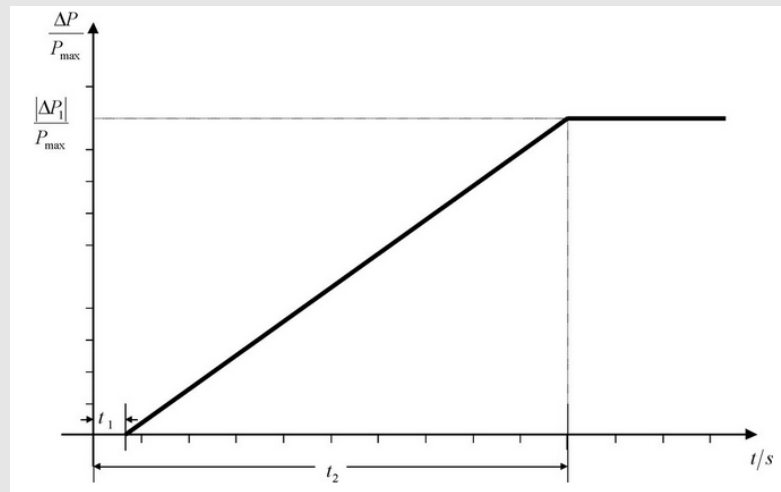

Figure 3- Active power frequency response capability ([1] Figure 6)

Parameter(s)/
Range(s) & value(s)

Parameters	Ranges
Active power range related to maximum capacity (frequency response range) $\frac{ \Delta P_1 }{P_{max}}$	1.5-10%
For PGMs with inertia, the maximum admissible initial delay t_1 unless justified otherwise in line with Article 15(2)(d)(iv)	2 s
For PGMs without inertia, the maximum admissible initial delay t_1 unless justified otherwise in line with Article 15(2)(d)(iv)	as specified by relevant TSO
Maximum admissible choice of full activation time t_2 , unless longer activation times are allowed by relevant TSO for reasons of system stability	30 s

Applicability

Type C and D PGMs

Requirement	<p>Frequency Sensitive Mode (3 of 3)</p> <p>FSM parameters will be determined considering:</p> <ul style="list-style-type: none"> • Technology characteristics of existing and new (planned) PGM in each country; • Analysis of significant network disturbance and FSM response of existing generators for each country; • Time period for the provision of full active power frequency response • Experiences of countries (in ENTSO-E CE) that have already defined these parameters.
Influencing factors/ Approach for requirement determination	<p>When determining FSM requirement typical control system of PGMs will be analysed.</p> <p>In regard to time period needed for initial activation of required active power frequency response, it should be noted that digital turbine controllers can cause a delay only in the case when significant filtering of turbine speed measurement is employed.</p> <p>When specifying the requirement for time period needed for providing full active power frequency response, the TSO should pay attention to PGM’s active power and primary energy source headroom. Following will be also considered:</p> <ul style="list-style-type: none"> • Technology characteristics of existing and new (planned) PGM in each country; • Analysis of significant network disturbance, especially the process when FSM system reserve is compensate with another reserve (secondary/FRR).
Proposer	TSO
Collaboration	Even though each TSO proposes the requirements regional TSOs cooperation is necessary when defining these requirements.

<p>Requirement</p> <p>Network Code</p>	<p>Limited Frequency Sensitivity Mode - Overfrequency (1 of 2)</p> <p>RfG, Article 13(2)(a), Article 13(2)(b), Article 13(2)(f)</p>
<p>Description</p>	<p>According to RfG, regarding LFSM-O PGMs shall be capable of activating the provision of active power frequency response according to Figure 4 at a frequency threshold and droop settings specified by the relevant TSO.</p> <p>TSO may choose to allow within its control area automatic disconnection and reconnection of PGMs of Type A at randomised frequencies, ideally uniformly distributed, above a frequency threshold, as determined by the relevant TSO where it is able to demonstrate to the NRA, in cooperation with PGFO, that this has a limited cross-border impact and maintains the same level of operational security in all system states.</p> <p>The relevant TSO may require that upon reaching minimum regulating level, PGM should be capable of either:</p> <ul style="list-style-type: none"> • continuing operation at this level; or • further decreasing active power output.
<p>Parameter(s)/ Range(s) & value(s)</p>	<p>Frequency threshold: between 50.2 Hz and 50.5 Hz inclusive;</p> <p>Droop: between 2 % and 12 %.</p> <div data-bbox="464 949 1353 1464" style="border: 1px solid black; padding: 10px; margin: 10px 0;"> <p style="text-align: center;"> $z_1 [\%] = 100 \cdot \frac{ \Delta f - \Delta f_1 }{f_n} \cdot \frac{P_{ref}}{ \Delta P }$ </p> <ul style="list-style-type: none"> • Synchronous Power Generating Modules: P_{ref} is the Maximum Capacity • Power Park Modules: P_{ref} is the actual Active Power output at the moment the LFSM-O threshold is reached or the Maximum Capacity, as defined by the Relevant TSO </div>
<p>Applicability</p>	<p>Automatic disconnection and reconnection settings for PGMs of Type A (non-mandatory).</p> <p>Operation below minimum regulating level requirements (non-mandatory)</p> <p>Type A, B, C and D PGMs for LFSM-O expect Automatic disconnection and reconnection settings that are only for type A PGM</p>

<p>Requirement</p> <p>Influencing factors/ Approach for requirement determination</p>	<p>Limited Frequency Sensitivity Mode - Overfrequency (2 of 2)</p> <p>Frequency threshold and droop should be determined considering droop and range requirements set out for FSM. When considering droop setting requirement, plan of area generation mix in next 10 years period and maximum planned generation surplus, should be additionally considered.</p> <p>When determining the requirement regarding automatic disconnection and reconnection of PGMs of Type A, following shall be considered:</p> <ul style="list-style-type: none"> • LFSM-O - Frequency threshold and droop settings • planned PGM type A penetration. <p>However there must be a hysteresis for both threshold and time setting between the conditions for disconnection and reconnection.</p> <p>When considering requirement regarding operation below minimum regulating level, minimum typical minimum power output levels at which PGMs can maintain stable operation shall be considered.</p>
<p>Proposer</p>	<p>TSO</p>
<p>Collaboration</p>	<p>TSO defines this requirement, and DSO must implement it for the PGMs connecting to the DS, according to scope of applicability given in RfG. Even though TSO determines these requirements for its control area coordination with the TSOs of the same synchronous area is needed to ensure minimal impacts on neighbouring systems.</p>

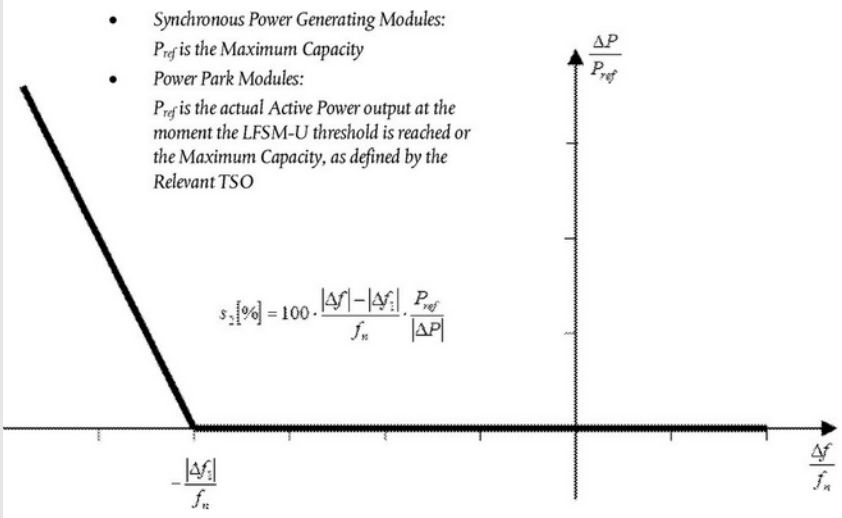
Requirement	Limited Frequency Sensitivity Mode - Underfrequency
Network Code	RfG, Article 15(2) (c)
Description	According to RfG, regarding LFSM-U PGMs shall be capable of activating the provision of active power frequency response according to Figure 5 at a frequency threshold and droop settings specified by the relevant TSO.
Parameter(s)/ Range(s) & value(s)	<p>Frequency threshold: between 49.8 Hz and 49.5 Hz inclusive; Droop: between 2 % and 12 %.</p>  <p> <ul style="list-style-type: none"> Synchronous Power Generating Modules: P_{ref} is the Maximum Capacity Power Park Modules: P_{ref} is the actual Active Power output at the moment the LFSM-U threshold is reached or the Maximum Capacity, as defined by the Relevant TSO </p> $s_2 [\%] = 100 \cdot \frac{ \Delta f - \Delta f_c }{f_n} \cdot \frac{P_{ref}}{ \Delta P }$
Definition of Pref	Definition of Pref
Applicability	Type C and D PGMs
Influencing factors/ Approach for requirement determination	Frequency threshold and droop should be determined considering droop and range requirements set out for FSM. When considering droop setting requirement, plan of area generation mix in next 10 years period and maximum planned generation surplus, should be additionally considered.
Proposer	TSO
Collaboration	TSO defines this requirement, and DSO must implement it for the PGMs connecting to the DS, according to scope of applicability given in RfG. Even though TSO determines these requirements for its control area coordination with the TSOs of the same synchronous area is needed to ensure minimal impacts on neighbouring systems.

Requirement	Admissible Active Power Reduction
Network Code	RfG, Article 13(4), Article 13(5)
Description	<p>RfG defines that the relevant TSO shall specify admissible active power reduction from maximum output with falling frequency in its control area as a rate of reduction conforming to the boundaries given in Figure 6, illustrated by the full lines</p> <p>The admissible active power reduction from maximum output, requirement shall:</p> <ul style="list-style-type: none"> • clearly specify the ambient conditions applicable; • take account of the technical capabilities of PGMs. <p>Admissible active power reduction from max. output with falling frequency</p> <p>Frequency threshold - maximum rate for every 1Hz of frequency droop:</p> <p>below 49Hz - 2% of Pmax at 50Hz</p> <p>below 49.5Hz - 10% of Pmax at 50Hz</p>
Parameter(s)/ Range(s) & value(s)	
Applicability	Type A, B, C and D PGMs
Influencing factors/ Approach for requirement determination	<p>When determining this requirement defined frequency ranges, stability of the system and PGM (CCGT) technology will be consider to determine this requirement.</p> <p>The consultant will request information from TSO/DSO regarding to the P/F characteristics of existing and planned CCGT. If there is not enough data, the consultant will use relevant data.</p>
Proposer	TSO
Collaboration	

Figure 6 - Maximum power capability reduction with falling frequency ([1] Figure 2)

Definition of the ambient conditions applicable when defining the admissible active power reduction

Requirement	Logic Interface and automatic connection to the network
Network Code	RfG, Article 13(6), Article 13(7), Article 14(b)(2)
Description	<p>According to RfG, the PGM shall be equipped with a logic interface (input port) in order to cease active power output within five seconds following receiving of an instruction. The RSO shall have the right to specify requirements for equipment to make this facility operable remotely.</p> <p>The relevant TSO shall specify the conditions under which PGM should be capable of connecting automatically to the network. Automatic connection is allowed unless specified otherwise by the RSO in coordination with the relevant TSO.</p>
Parameter(s)/ Range(s) & value(s)	<p>Requirements for equipment needed in order to enable remote activation of this service.</p> <p>Conditions for automatic connection:</p> <ul style="list-style-type: none"> • frequency ranges within which an automatic connection is admissible, and a corresponding delay time; and • maximum admissible gradient of increase in active power output.
Applicability	<p>Type A and B for requirements for the additional equipment necessary to allow active power output to be remotely operable</p> <p>Type A, B and C for requirements conditions for automatic connection to the network regarding, frequency ranges, corresponding delay time and maximum admissible gradient of increase in active power output</p> <p>Type B PGM for requirements for the equipment necessary to make the logic interface remotely operable (to cease active power output)</p>
Influencing factors/ Approach for requirement determination	<p>When defining requirement regarding automatic connection it is very important that the set automatic connection ranges are sync with requirements for disconnection ranges, in order to provide hysteresis and time delay between connection and disconnection ranges and thresholds.</p> <p>Maximum admissible gradient of increase in active power output after automatic connection should be some uniform value, e.g. 20%/min, it is only important that gradient is not like step response.</p> <p>The requirements regarding logic input are non-mandatory, and decision whether to introduce this requirement or not will greatly depend on TSO's and DSO's SCADA system capabilities, i.e. whether existing systems can support such services.</p>
Proposer	RSO
Collaboration	When defining before mentioned requirements coordination between TSO and DSO is necessary

Requirement	Frequency Stability
Network Code	RfG, Article 15(2)(a)
Description	According to RfG with regard to active power controllability and control range, the PGM's control system shall be capable of adjusting an active power setpoint in line with instructions given to the PGFO by the RSO or the relevant TSO.
Parameter(s)/ Range(s) & value(s)	RSO or the relevant TSO shall establish the time period within which the adjusted active power setpoint must be reached. The relevant TSO shall specify a tolerance (subject to the availability of the prime mover resource) applying to the new setpoint and the time within which it must be reached;
Applicability	Type C and D PGMs
Influencing factors/ Approach for requirement determination	When determining this requirement technology characteristics of different PGM will be taken into account. The most important is prime mover resource and maximum active power rate of change.
Proposer	TSO
Collaboration	TSO should cooperate with PGFO.

Requirement	Frequency Restoration Control
Network Code	RfG, Article 15(2)(e)
Description	The power-generating module shall provide functionalities complying with specifications specified by the relevant TSO, aiming at restoring frequency to its nominal value or maintaining power exchange flows between control areas at their scheduled values
Parameter(s)/ Range(s) & value(s)	Specifications of the frequency restoration control
Applicability	Type C, D
Influencing factors/ Approach for requirement determination	The most important parameters and functionalities of the AGC system will be specified. Primary energy source of the power-generating module will be consider.
Proposer	TSO
Collaboration	Coordination TSO - PGFO is necessary.

Requirement	Real-Time Monitoring of FSM
Network Code	RfG, Article 15(2)(g)
Description	<p>According to RfG, with regard to real-time monitoring of FSM:</p> <ul style="list-style-type: none"> to monitor the operation of active power frequency response, the communication interface shall be equipped to transfer in real time and in a secured manner from the power-generating facility to the network control centre of the relevant system operator or the relevant TSO, at the request of the relevant system operator or the relevant TSO, at least the following signals: <ul style="list-style-type: none"> status signal of FSM (on/off), scheduled active power output, actual value of the active power output, actual parameter settings for active power frequency response, droop and deadband; the relevant system operator and the relevant TSO shall specify additional signals to be provided by the power-generating facility by monitoring and recording devices in order to verify the performance of the active power frequency response provision of participating power-generating modules.
Parameter(s)/ Range(s) & value(s)	<p>List of the necessary data which will be sent in real time:</p> <p>status signal of FSM (on/off),</p> <ul style="list-style-type: none"> scheduled active power output, actual value of the active power output, actual parameter settings for active power frequency response, droop and deadband; <p>Definition of additional signals</p>
Applicability	Type C, D
Influencing factors/ Approach for requirement determination	<p>Other parameters that are important for FSM response will be analysed:</p> <ul style="list-style-type: none"> limits of active power, control mode of PGM, ...
Proposer	RSO or TSO
Collaboration	Coordination TSO - PGFO is necessary.

Requirement	Rates of Change of Active Power Output
Network Code	RfG, Article 15(6)(e)(d)
Description	<p>According to RfG the relevant system operator shall specify, in coordination with the relevant TSO, minimum and maximum limits on rates of change of active power output (ramping limits) in both an up and down direction of change of active power output for a power-generating module, taking into consideration the specific characteristics of prime mover technology</p> <p>With regard to the installation of devices for system operation and devices for system security, if the relevant system operator or the relevant TSO considers that it is necessary to install additional devices in a power-generating facility in order to preserve or restore system operation or security, the relevant system operator or relevant TSO and the power-generating facility owner shall investigate that matter and agree on an appropriate solution.</p>
Parameter(s)/ Range(s) & value(s)	<p>Minimum limit of change of active power output in down direction</p> <p>Maximum limit of change of active power output in down direction</p> <p>Minimum limit of change of active power output in up direction</p> <p>Maximum limit of change of active power output in up direction</p> <p>Additional devices for secure system operation</p>
Applicability	Type C and D of PGM
Influencing factors/ Approach for requirement determination	<p>Minimum and maximum limits on rates of changes of active power output will be define considering system requirements and capabilities of different type of PGM, taking into account prime mover technology.</p> <p>The needs of the TSO will be taken into account (necessary gradient of Replacement Reserves).</p> <p>The parameter also has a regional character, especially at the time of the full period (one hour) in terms of the consequences of electricity trade.</p> <p>In purpose to determine additional devices for secure system operation, some kind of research will be conducted to determine what devices exist that can contribute to the stability of the system response (expect PSS). The characteristics of the system will be taken into account.</p>
Proposer	RSO
Collaboration	Coordination TSO - PGFO is necessary.

2.1.3. Voltage Issues

Requirement	Voltage Ranges (1 of 2)																			
Network Code	RfG, Article 16(2)(a)(b)																			
Description	<p>RfG defines requirements for type D PGM, regarding minimum time period that the PGM should be capable to stay connected to the network and operate, as a function of voltage level at the connection point.</p> <p>RSO in coordination with relevant TSO and the PGFO may agree on wider voltage ranges and/or longer times for operation or specific requirements for combined frequency and voltage deviations</p> <p>Time period for which PGMs shall be capable to stay connected to the grid for upper voltage range at the connection point between.</p> <p><i>Minimum time periods during which a PGM must be capable of operating without disconnecting from the network, for grid of nominal voltage level from 110 kV to 300 kV</i></p> <table border="1"> <thead> <tr> <th>Synchronous area</th> <th>Voltage range</th> <th>Time period for operation</th> </tr> </thead> <tbody> <tr> <td rowspan="4">Continental Europe</td> <td>0.85 pu - 0.9 pu¹</td> <td>60 minutes</td> </tr> <tr> <td>0.9 pu - 1.118 pu</td> <td>Unlimited</td> </tr> <tr> <td>1.118 pu - 1.15 pu</td> <td>To be specified by each TSO, but not less than 20 minutes and not more than 60 minutes</td> </tr> <tr> <td>0.85 pu - 0.9 pu</td> <td>60 minutes</td> </tr> <tr> <td rowspan="3">Georgia</td> <td>0.9 pu - 1.2 pu</td> <td>Unlimited</td> </tr> <tr> <td>1.2 pu - 1.15 pu</td> <td>20 minutes</td> </tr> <tr> <td>0.85 pu - 0.9 pu</td> <td>60 minutes</td> </tr> </tbody> </table>	Synchronous area	Voltage range	Time period for operation	Continental Europe	0.85 pu - 0.9 pu ¹	60 minutes	0.9 pu - 1.118 pu	Unlimited	1.118 pu - 1.15 pu	To be specified by each TSO, but not less than 20 minutes and not more than 60 minutes	0.85 pu - 0.9 pu	60 minutes	Georgia	0.9 pu - 1.2 pu	Unlimited	1.2 pu - 1.15 pu	20 minutes	0.85 pu - 0.9 pu	60 minutes
Synchronous area	Voltage range	Time period for operation																		
Continental Europe	0.85 pu - 0.9 pu ¹	60 minutes																		
	0.9 pu - 1.118 pu	Unlimited																		
	1.118 pu - 1.15 pu	To be specified by each TSO, but not less than 20 minutes and not more than 60 minutes																		
	0.85 pu - 0.9 pu	60 minutes																		
Georgia	0.9 pu - 1.2 pu	Unlimited																		
	1.2 pu - 1.15 pu	20 minutes																		
	0.85 pu - 0.9 pu	60 minutes																		
Parameter(s)/ Range(s) & value(s)	<p><i>Minimum time periods during which a PGM must be capable of operating without disconnecting from the network, for grid of nominal voltage level from 300 kV to 500 kV</i></p> <table border="1"> <thead> <tr> <th>Synchronous area</th> <th>Voltage range</th> <th>Time period for operation</th> </tr> </thead> <tbody> <tr> <td rowspan="4">Continental Europe</td> <td>0.85 pu - 0.9 pu</td> <td>60 minutes</td> </tr> <tr> <td>0.9 pu - 1.05 pu</td> <td>Unlimited</td> </tr> <tr> <td>1.05 pu - 1.1 pu</td> <td>To be specified by each TSO, but not less than 20 minutes and not more than 60 minutes</td> </tr> <tr> <td>0.85 pu - 0.9 pu</td> <td>60 minutes</td> </tr> <tr> <td rowspan="3">Georgia</td> <td>0.9 pu - 1.1 pu</td> <td>Unlimited</td> </tr> <tr> <td>1.2 pu - 1.15 pu</td> <td>20 minutes</td> </tr> <tr> <td>0.85 pu - 0.9 pu</td> <td>60 minutes</td> </tr> </tbody> </table> <p>Shorter period of times from those defined in previous tables in case of simultaneous voltage and frequency deviations, i.e. under voltage and over frequency or over voltage and under frequency conditions. (non-mandatory)</p> <p>Wider voltage ranges and/or longer time periods for operation to be agreed between RSO and PGFO In coordination with relevant TSO.</p>	Synchronous area	Voltage range	Time period for operation	Continental Europe	0.85 pu - 0.9 pu	60 minutes	0.9 pu - 1.05 pu	Unlimited	1.05 pu - 1.1 pu	To be specified by each TSO, but not less than 20 minutes and not more than 60 minutes	0.85 pu - 0.9 pu	60 minutes	Georgia	0.9 pu - 1.1 pu	Unlimited	1.2 pu - 1.15 pu	20 minutes	0.85 pu - 0.9 pu	60 minutes
Synchronous area	Voltage range	Time period for operation																		
Continental Europe	0.85 pu - 0.9 pu	60 minutes																		
	0.9 pu - 1.05 pu	Unlimited																		
	1.05 pu - 1.1 pu	To be specified by each TSO, but not less than 20 minutes and not more than 60 minutes																		
	0.85 pu - 0.9 pu	60 minutes																		
Georgia	0.9 pu - 1.1 pu	Unlimited																		
	1.2 pu - 1.15 pu	20 minutes																		
	0.85 pu - 0.9 pu	60 minutes																		

¹ Note that 1 pu corresponds to nominal voltage level of the grid, except in the case of 380 kV and 400 kV nominal voltage levels where 1 pu corresponds to the value of 400 kV.

Requirement	Voltage Ranges (2 of 2)																	
	<p><i>Minimum time period during which an AC Connected off-shore PPM must be capable of operating over specified voltage range</i></p> <table border="1"> <thead> <tr> <th>Synchronous area</th> <th>Voltage range</th> <th>Time period for operation</th> </tr> </thead> <tbody> <tr> <td rowspan="5" style="text-align: center;">Continental Europe</td> <td>0.85 pu - 0.9 pu</td> <td>60 minutes</td> </tr> <tr> <td>0.9 pu - 1.118 pu</td> <td>Unlimited</td> </tr> <tr> <td>1.118 pu -1.15 pu (*)</td> <td>To be specified by each TSO, but not less than 20 minutes and not more than 60 minutes</td> </tr> <tr> <td>0.9 pu - 1.05 pu (**)</td> <td>Unlimited</td> </tr> <tr> <td>1.05 pu - 1.1 pu (**)</td> <td>To be specified by each TSO, but not less than 20 minutes and not more than 60 minutes</td> </tr> <tr> <td colspan="3"> (*) The voltage base for pu values is below 300 kV. (**)The voltage base for pu values is from 300 kV to 400 kV. </td> </tr> </tbody> </table> <p>Shorter period of times from those defined in previous tables in case of simultaneous voltage and frequency deviations, i.e. under voltage and over frequency or over voltage and under frequency conditions. (non-mandatory)</p> <p>Wider voltage ranges and/or longer time periods for operation to be agreed between RSO and PGFO In coordination with relevant TSO.</p>	Synchronous area	Voltage range	Time period for operation	Continental Europe	0.85 pu - 0.9 pu	60 minutes	0.9 pu - 1.118 pu	Unlimited	1.118 pu -1.15 pu (*)	To be specified by each TSO, but not less than 20 minutes and not more than 60 minutes	0.9 pu - 1.05 pu (**)	Unlimited	1.05 pu - 1.1 pu (**)	To be specified by each TSO, but not less than 20 minutes and not more than 60 minutes	(*) The voltage base for pu values is below 300 kV. (**)The voltage base for pu values is from 300 kV to 400 kV.		
Synchronous area	Voltage range	Time period for operation																
Continental Europe	0.85 pu - 0.9 pu	60 minutes																
	0.9 pu - 1.118 pu	Unlimited																
	1.118 pu -1.15 pu (*)	To be specified by each TSO, but not less than 20 minutes and not more than 60 minutes																
	0.9 pu - 1.05 pu (**)	Unlimited																
	1.05 pu - 1.1 pu (**)	To be specified by each TSO, but not less than 20 minutes and not more than 60 minutes																
(*) The voltage base for pu values is below 300 kV. (**)The voltage base for pu values is from 300 kV to 400 kV.																		
Applicability	Type D PGMs																	
Influencing factors/ Approach for requirement determination	<p>Regarding time period to be defined by relevant TSO, as pointed out in [8] it has to be defined as a compromise, i.e. defined time period shall be long enough to allow TSO to take necessary actions in order to get back voltage at unlimited permissible levels, and on the other hand it has to be short enough not to cause damage to HV connected equipment. Main influence on this value will have employed secondary voltage control, i.e. if there is automatic secondary voltage control employed than the lower values can be specified, as well as the connected equipment characteristics, and overall state of connected equipment. The chosen time period shall be short enough not to jeopardize system's operational security in situations with higher voltage levels.</p> <p>Regarding wider voltage ranges and/or longer times it should be noted that if those are economically and technically feasible PGFO should not "unreasonably withhold an argument" (as stated in RfG Article 16(2)(b)).</p>																	
Proposer	TSO or for some of the requirements agreement between the RSO and the PGFO																	
Collaboration	<p>As stated in [8] cooperation between TSOs regarding voltage ranges is needed in cases where more than one TSO operates in same country or between TSO from interconnected countries. This is important because higher normal operating ranges in one country may create similarly higher voltages that could be beyond the specified range adjacent network, or lead to excessive reactive power transit over interconnection.</p> <p>Also as stated at [8] TSO-DSO cooperation may be necessary regarding requirements for voltage ranges, as well as time period the facilities should be capable of operating under these conditions.</p>																	

Requirement **Fault ride through capability (1 of 2)**

Network Code **RfG, Article 14(3)(a)(b), 16(3)(a)(i), 16(3)(b)(i-iii), 16(3)(c)**

FRT capability requirement defines minimum time period that PGMs have to be capable of staying connected to the grid, after fault conditions (i.e. secured faults) leading to decrease of voltage at unit's connection point.

Regarding FRT capability requirements for asymmetrical faults, it is left up to each TSO to define these.

Description

At $t=0$ fault occurs leading to voltage decrease at connection point to value U_{ret} . The fault is cleared after t_{clear} seconds. After the fault is cleared voltage starts to recover. Immediately after the fault is cleared voltage rises to value U_{clear} . Dynamics of voltage recovery after the fault is cleared is defined with three pair of points (t_{rec1}, U_{rec1}) , (t_{rec2}, U_{rec2}) and (t_{rec3}, U_{rec3}) .

The protection schemes and settings for internal electrical faults must not jeopardize FRT performance.

FRT voltage-against time profile, at connection point, according to following figure, defining lower limit of the phase-to-phase voltages at the connection point, expressed in per units relative to network nominal voltage level during a symmetrical fault, as a function of time before, during and after the fault.

Parameter(s)/
Range(s) & value(s)

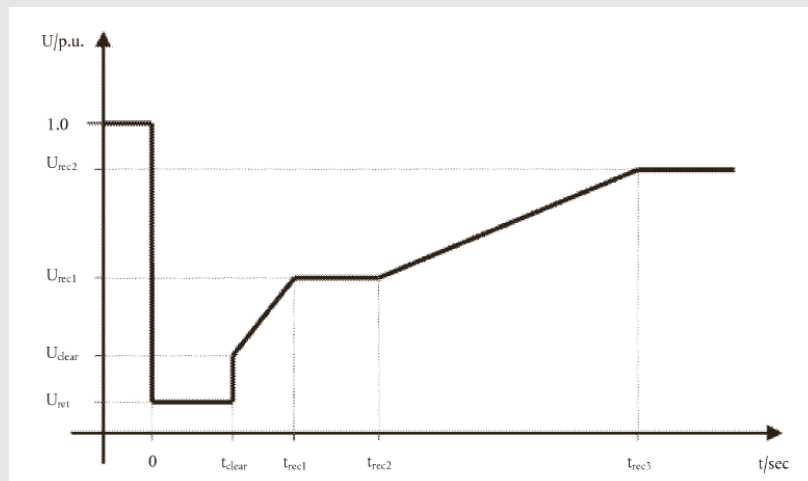

Figure 7 - FRT profile of power generating module ([1] Figure 3)

Parameters that determines FRT curve: U_{ret} , t_{clear} , U_{clear} , t_{rec1} , U_{rec1} , t_{rec2} , U_{rec2} , t_{rec3} , U_{rec3} , according to ranges given in following tables.

Requirement

Fault ride through capability (1 of 3)

Ranges for FRT curve parameters' values for Type B, C and D SPGMs connected at voltage level below 110 kV ([1] Table 3.1)

Voltage parameters (pu)		Time parameters (seconds)	
U_{ret}	0.05 - 0.3	t_{clear}	0.14 - 0.15 (or 0.14-0.25 if system protection and secure operation so require)
U_{clear}	0.7 - 0.9	t_{rec1}	t_{clear}
U_{rec1}	U_{clear}	t_{rec2}	$t_{rec1} - 0.7$
U_{rec2}	0.85 - 0.9 and $\geq U_{clear}$	t_{rec3}	$t_{rec2} - 1.5$

Ranges for FRT curve parameters' values for Type B, C and D PPMs connected at voltage level below 110 kV ([1] Table 3.2)

Voltage parameters (pu)		Time parameters (seconds)	
U_{ret}	0.05 - 0.15	t_{clear}	0.14 - 0.15 (or 0.14-0.25 if system protection and secure operation so require)
U_{clear}	$U_{ret} - 0.9$	t_{rec1}	t_{clear}
U_{rec1}	U_{clear}	t_{rec2}	t_{rec1}
U_{rec2}	0.85	t_{rec3}	1.5 - 3.0

Range for FRT curve parameters' values for Type D SPGMs connected at or above 110 kV ([1] Table 7.1)

Voltage parameters (pu)		Time parameters (seconds)	
U_{ret}	0	t_{clear}	0.14 - 0.15 (or 0.14-0.25 if system protection and secure operation so require)
U_{clear}	0.25	t_{rec1}	$t_{clear} - 0.45$
U_{rec1}	0.5 - 0.7	t_{rec2}	$t_{rec1} - 0.7$
U_{rec2}	0.85 - 0.9	t_{rec3}	$t_{rec2} - 1.5$

Range for FRT curve parameters' values for type D PPM connected at or above 110 kV ([1] Table 7.2)

Voltage parameters (pu)		Time parameters (seconds)	
U_{ret}	0	t_{clear}	0.14 - 0.15 (or 0.14-0.25 if system protection and secure operation so require)
U_{clear}	U_{ret}	t_{rec1}	t_{clear}
U_{rec1}	U_{clear}	t_{rec2}	t_{rec1}
U_{rec2}	0.85	t_{rec3}	1.5 - 3.0

The pre-fault and post-fault conditions for the FRT capability:

- pre-fault minimum short circuit capacity at the connection point (expressed in MVA)
- pre-fault active and reactive power operating point of the PGM at the connection point and voltage at the connection point
- the post-fault minimum short circuit capacity at the connection point (expressed in MVA).

Parameter(s)/
Range(s) & value(s)

Requirement	Fault ride through capability (3 of 3)
Applicability	Type B, C and D PGMs for symmetrical faults Type C and D PGMs for asymmetrical faults
Influencing factors/ Approach for requirement determination	Main factors contributing to generator's ability to meet FRT requirement is determined by generator parameters (mainly overall inertia), AVR response, value of reactance between generator and connection point (e.g. unit step-up transformer reactance) and unit's pre-fault operating point. Regarding pre-fault condition RfG defines in Article 14.3(a)(iv) that each TSO shall specify and make publicly available the pre-fault and post-fault conditions for the FRT capability. These data TSO shall provide at the request of a power-generating facility owner, as an outcome of the calculations for given connection point, or alternatively it may provide generic values derived from typical cases. Note also, that for type D PGMs RfG article 16.3.(b) does not explicitly state that in response to PFGO request about pre-fault and post-fault conditions, relevant TSO "may provide generic values derived from typical cases", as it is allowed for type B and C PGMs (Article 14.3.(a).(v)).
Proposer	TSO
Collaboration	When defining before mentioned requirements coordination between TSO and DSO is necessary

Requirement	Automatic Disconnection due to Voltage Level
Network Code	RfG, Article 15(3), Article 16(2)(c)
Description	Under general requirements for type C PGM and type D, RfG defines that these PGMs shall be cable of automatic disconnection when voltage at connection point reaches predefined levels.
Parameter(s)/ Range(s) & value(s)	Levels and settings for automatic disconnection (non-mandatory)
Applicability	Type C and D PGMs
Influencing factors/ Approach for requirement determination	<p>Requirement is site specific and non-mandatory for type D PGMs. Parameter values should be determined based on the fact whether or not PGM at hand contributes, or it has diverse effect on voltage control during the disturbance. In the first case, the PGM should stay connected as long as possible within whole voltage range defined at national level to contribute to voltage restoration. In the second case, the PGM should be disconnected to prevent it to further contribute to voltage disturbance.</p> <p>As pointed out in [8] the delay between the time the voltage reaches the voltage criteria and the actual disconnection is also subject of specification at national level, as compromise. It should be long enough to prevent unnecessary disconnection of PGM during transient voltage deviation, but short enough to prevent HV equipment damage.</p> <p>The time for resynchronization after disconnection should also be taken into consideration at national level.</p>
Proposer	RSO
Collaboration	Collaboration with RSO and relevant TSO

Requirement **Reactive Power Capability (1 of 3)**

Network Code **RfG, Article 17(2)(a)**

RfG defines, that in the case of Type C and D PGMs, RSO have the right to define the required reactive power capability, according to predefined ranges. For Type B PGMs according to the RfG defines that RSO have the right to specify the capability of a power park module to provide reactive power.

In case of Type B PGMs this is a non-mandatory requirement.

Description

Regarding rate of change, RfG does not give any guidance, except that the PGM needs to be capable to operate at any point in defined U-Q/Pmax area, and to move to any operating point at the request of RSO in "appropriate timescale".

In the case of Type C and D PGMs for which connection point is neither at high voltage terminals of the step-up transformer nor at the generator terminals if PGM is directly connected to the grid, RSO may specify supplementary reactive power.

Voltage-reactive power profile at maximum capacity or U-Q/Pmax at connection point (depending of the voltage value at connection point)

Maximum ranges for profile to be defined is given in form of two envelopes (see Figure 8 for SPGM and Figure 9 for PPM):

- inner envelope - given in form of a rectangular, defines maximum voltage and Q/Pmax ranges, and
- outer envelope - given also in form of a rectangular, determines area in U-Q/Pmax plane where defined profile can be positioned.

Parameter(s)/
Range(s) & value(s)

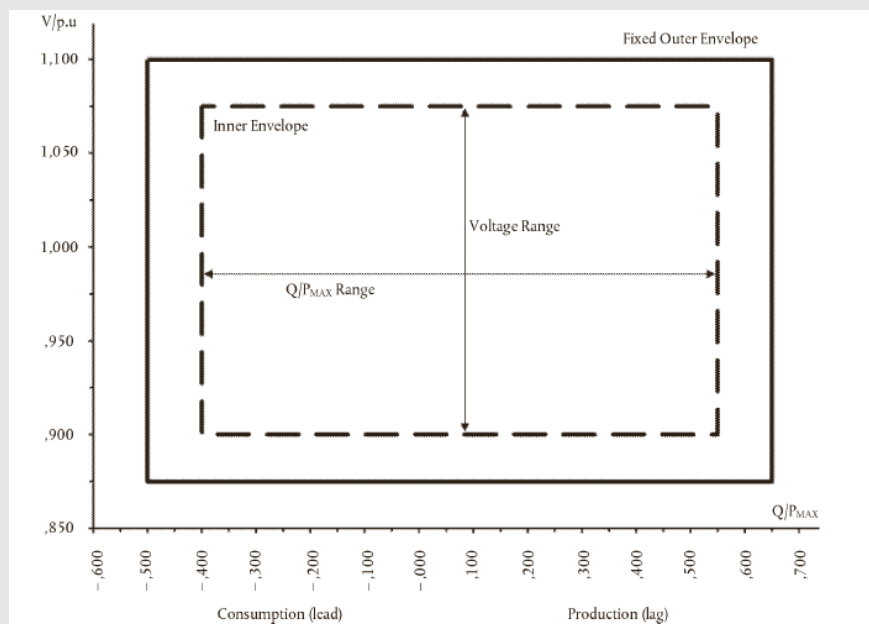

Figure 8 - Envelopes of U-Q/Pmax profile applicable for SPGM (Figure 7 [1])²

Maximum values for inner envelope in Figure 8

Synchronous area	Maximum Q/Pmax	Maximum range of steady- state voltage level in PU
Continental Europe	0.95	0.225

² The position, size and shape of the inner envelope are indicative

Requirement

Reactive Power Capability (2 of 3)

Parameter(s)/
Range(s) & value(s)

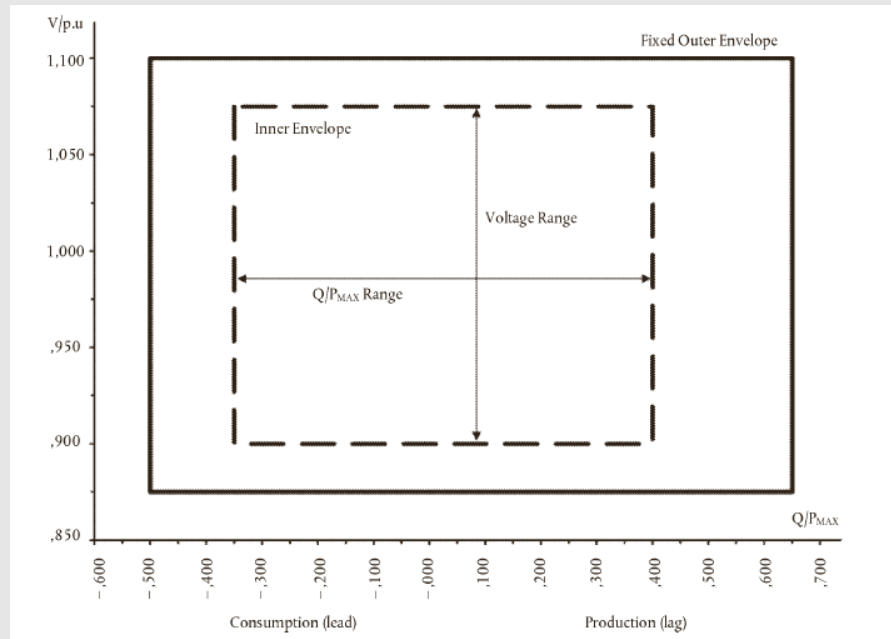

Figure 9 - Envelopes of U-Q/P_{max} profile applicable for PPM (Figure 8 [1])³

Maximum values for inner envelope in Figure 9

Synchronous area	Maximum Q/Pmax	Maximum range of steady- state voltage level in PU
Continental Europe	0.75	0.225

Have in mind that profile can take any shape (shapes other than rectangular), and that the maximum voltage range represents difference between highest and lowest point of the defined figure.

Calculated U-Q/Pmax profile of each PGM should be greater than defined profile, i.e. calculated U-Q/Pmax profile should encompass whole area defined by the U-Q/Pmax including border points.

Supplementary reactive power (not mandatory)

Applicability

Type B, C and D PGMs

³ The position, size and shape of the inner envelope are indicative

Requirement	Reactive Power Capability (3 of 3)
Influencing factors/ Approach for requirement determination	<p>The profile may take any shape, but costs of delivering the capability to provide reactive power production at high voltages and reactive power consumption at low voltages should be taken into account.</p> <p>Capability of PGM to fulfill set U-Q/Pmax requirement depends on PGM’s parameters, in the case of SPGMs mainly on generator and unit transformer parameters. In determining this requirement typical PGM’s equipment data should be considered.</p> <p>The width of the calculated U-Q/Pmax characteristics for PGM will be dictated by the generators lading and lagging power factor at maximum capacity, unit transformer impedance and amount of unit’s ancillary consumption if supplied directly from generator’s terminals. So the wider the required profile is the lower value of leading and lagging power factor of the generator is needed, leading to higher dimensions and costs of the generator.</p> <p>On the other hand height of the calculated U-Q/Pmax characteristics of a PGM will depend on maximum permissible voltage deviation at generators terminals at continuous operation and unit transformer’s transformation ratio. In this case use of tap changer can have positive effects on PGM’s overall U-Q/Pmax capability. Change of tap position has the effect of shifting up or down calculated U-Q/Pmax capability of given PGM corresponding to tap changer’s neutral position.</p> <p>Supplementary reactive power applicable for remotely connected PGMs, in order to compensate reactive power losses of the connecting HV line or cable, between step up transformer HV terminals, or generator terminal if step up transformer is not used, and connection point. In case of this parameter if RSO chooses to define it, it can be defined based on typical values of HV line or cable reactance for unity length (Ω/km), if calculated reactive power losses are above certain threshold value.</p>
Proposer	RSO
Collaboration	Close cooperation and interaction between TSO-DSO is to be expected in all aspects regarding reactive power capabilities, especially in the case of significant RES penetration.

Requirement Reactive Power Capability below maximum power (1 of 2)

Network Code RfG, Article 18(2)(b)(i)

Description
 SPGM needs to be capable to operate at every permissible operating point as defined by the generator’s capability diagram, for output below maximum, up to minimum stable active power operating point. In other words at lower active power loadings, SPGMs need to be able to provide full reactive power capacity as defined with generator’s capability diagram, taking into account effects of reactive power losses at unit transformer (if present) and auxiliary consumption requirements (if supplied from generator’s terminals).

For Type C and D PPMs requirements for reactive power production/consumption for active power below maximum capacity are defined by RSO in coordination with relevant TSO in form of P-Q/P_{max} profile.

P-Q/P_{max} profile at connection point for PPMs (depending of the voltage value at connection point)

Maximum ranges for profile to be defined is given in form of two envelopes (see Figure 3 for SPGM and Figure 4 for PPM):

- inner envelope - given in form of a rectangular, defines maximum voltage and Q/P_{max} ranges, and
- outer envelope - given also in form of a rectangular, determines area in P-Q/P_{max} plane where defined profile can be positioned.

At zero reactive power, i.e. Q/P_{max}=0 the active power range shall be 1 pu, corresponding to maximum active power capacity P_{max}.

Parameter(s)/ Range(s) & value(s)

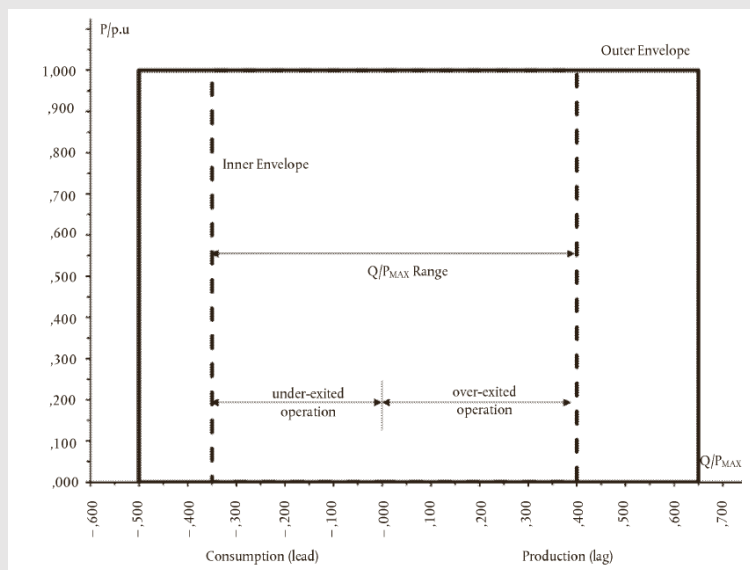

Figure 10 - Envelopes of P-Q/Pmax profile applicable for Type C and D PPMs (Figure 9 [1])⁴

Synchronous area	Maximum Q/Pmax	Maximum range of steady- state voltage level in PU
Continental Europe	0.75	0.225

⁴ The position, size and shape of the inner envelope are indicative

Requirement	Reactive Power Capability below maximum power (2 of 2)
Applicability	Type C and D PPMs
Influencing factors/ Approach for requirement determination	<p>The philosophy related to determining this requirement is complex as it will depend on development plans, expected RES penetration and SPGM decommissioning scenarios, and it will be explained in more details in the methodology during Task 3 of the project. One thing to have in mind, as pointed out in [10] is that provision of the reactive power at active power levels below P_{max} can be achieved but due to technology characteristics it can be dependent on additional equipment being installed. As an example in [10] is explained that in the case when active power is decreased from maximum to zero, the reactive power produced/absorbed by user's non-PPM equipment (e.g. transformers, cables etc.) will change, and therefore additional compensation equipment may be required to ensure that the same reactive power level is maintained at connection point.</p>
Proposer	RSO
Collaboration	Close cooperation and interaction between TSO-DSO is to be expected in all aspects regarding reactive power capabilities, especially in the case of significant RES penetration..

<p>Requirement</p> <p>Network Code</p>	<p>Voltage/Reactive Power Control (1 of 2)</p> <p>RfG, Article Article 19(2)(a), 20(2)(a), 21(3)(b), 21(3)(c)(i), 21(3)(c)(iv), 21(3)(d)(iv), 21(3)(d)(vi-vii), 21(3)(e-f), 25(1), 25(5)</p>
<p>Description</p>	<p>For Type D SPGMs RSO in coordination with relevant TSO, shall agree on AVR parameters and settings with PGFO.</p> <p>RSO in coordination with relevant TSO and the PGFO may agree on wider frequency ranges and/or longer times for operation or specific requirements for combined frequency and voltage deviations</p> <p>Type C and D PPMs should have AVR working in either voltage control mode, reactive power control mode or power factor control mode</p> <p>RSO defines response of PPM to step voltage change.</p> <p>PPM operating in voltage control mode:</p> <ul style="list-style-type: none"> • voltage set point, • slope - defined as the ratio of the change in voltage, based on reference 1 pu voltage, to a change in reactive power, based on maximum reactive power, • and dead band (set as exhaustive⁵) <p>In reactive power control mode set point is reactive power. Allowable set point value is defined through requirements for PPM reactive power capabilities. Requirements regarding reactive power control mode of PPMs are set as exhaustive.</p> <p>Regarding PPMs operation in power factor control mode RSO shall specify the target power factor value, its tolerance and allowable period of time needed in order to achieve new power factor value, following a sudden change in active power output. The power factor tolerance should be expressed through the tolerance of reactive power, either as an absolute value (i.e. in Mvar) or as percentage of PPM's maximum reactive power output.</p>
<p>Parameter(s)/ Range(s) & value(s)</p>	<p><u>SPGM</u></p> <p>Steady state and transient performance of voltage regulation;</p> <p>Performance of the excitation control system:</p> <ul style="list-style-type: none"> • including excitation control system bandwidth, • under excitation limiter settings, • over excitation limiter settings, • stator current limiter, and • PSS function of an AVR. <p>SGPM capacity threshold above which the PSS functionality shall be activated.</p> <p>Agreement regarding angular stability aid from SPGM during fault conditions (RSO and PGFO).</p>

⁵ For further information see RfG Articles 21.3(d)(ii) and Article 21.3(d)(iii)

Requirement	<p>Voltage/Reactive Power Control (2 of 2)</p>				
Parameter(s)/ Range(s) & value(s)	<p>PPM</p> <p>PPM's response to step change in voltage: following voltage step change PPM should be capable in achieving 90% of final reactive power in t_1 seconds following the change. PPM should also be capable of settling to final reactive power value in t_2 seconds after the step voltage change. Before mentioned final value of reactive power is the stationary value of reactive power corresponding to new voltage level, and it depends on slope setting. RSO defines values for t_1 and t_2 having in mind allowable range of these parameters:</p> <table border="1" data-bbox="638 582 1181 672"> <thead> <tr> <th>Parameter t_1 range</th> <th>Parameter t_2 range</th> </tr> </thead> <tbody> <tr> <td>1 s - 5 s</td> <td>5 s - 60 s</td> </tr> </tbody> </table> <p>Voltage/reactive power control mode is to be implemented, and</p> <p>Additional equipment needed in order to be able to adjust relevant set point remotely.</p> <p>Active or reactive power prioritization during faults for which FRT capability is required</p> <p>Require from PPMs capable of contributing to damping of power oscillations to contribute (not mandatory)</p>	Parameter t_1 range	Parameter t_2 range	1 s - 5 s	5 s - 60 s
Parameter t_1 range	Parameter t_2 range				
1 s - 5 s	5 s - 60 s				
Applicability	<p>Type D SPGMs, Type B, C and D PPMs</p>				
Influencing factors/ Approach for requirement determination	<p>The choice of voltage/reactive power control mode to be implemented should be determined based on TSO's employed system management strategy. As stated in [9] these modes are intended in order to allow system to operate in an acceptable and secure state prior to perturbation, and to support voltages in the case of system perturbations while remedial actions are put into place by the system operators. These modes are therefore intended for steady and quasi steady state operation. For voltage support during fast transient situations (e.g. short circuits) fast fault contribution requirements are provided.</p> <p>Regarding active or reactive power prioritization during faults, giving priority to active power will ensure more efficient active power restoration after the disturbance, but on the other hand reactive power priority will provide better voltage support during the faults. Therefore in [8] it is recommended that in cases when the faults are quickly cleared by protection system, the priority can be given to active power contribution, else priority should be given to reactive power contribution. The other thing to consider is overall system inertia. For systems with low inertia, priority shall be given to active power.</p>				
Proposer	<p>RSO</p>				
Collaboration	<p>As stated in [9] there are no special requirements regarding TSO-TSO cooperation, but TSO-DSO cooperation is important for type C and D DCO connected PPMs.</p>				

Requirement	Fast fault current capability
Network Code	RfG, Article 20(2)(b)(ii)
Description	<p>RSO in coordination with TSO may specify the requirements regarding PPM's capability of providing fast fault current in case of symmetrical faults.</p> <p>In case of asymmetrical faults, the RSO in coordination with relevant TSO may define a requirement, for asymmetrical current injection.</p>
Parameter(s)/ Range(s) & value(s)	<p><u>For symmetrical faults and asymmetrical faults</u></p> <p>How and when a voltage deviation is to be determined as well as the end of voltage deviation.</p> <p>Time domain characteristics of voltage deviation and fast fault current measuring</p> <p>Timing and accuracy if the fast fault current, which may include several stages during a fault and after its clearance.</p>
Parameter(s)/ Range(s) & value(s)	<p><u>PPM</u></p> <p>PPM's response to step change in voltage: following voltage step change PPM should be capable in achieving 90% of final reactive power in t_1 seconds following the change. PPM should also be capable of settling to final reactive power value in t_2 seconds after the step voltage change. Before mentioned final value of reactive power is the stationary value of reactive power corresponding to new voltage level, and it depends on slope setting. RSO defines values for t_1 and t_2 having in mind allowable range of these parameters:</p> <p>Voltage/reactive power control mode is to be implemented, and</p> <p>Additional equipment needed in order to be able to adjust relevant set point remotely.</p> <p>Active or reactive power prioritization during faults for which FRT capability is required</p> <p>Require from PPMs capable of contributing to damping of power oscillations to contribute (not mandatory)</p>
Applicability	Type B, C and D PPMs (not mandatory)
Influencing factors/ Approach for requirement determination	As stated in [11] the objective of this requirement is to limit the consequences of a short circuit with regards to unwanted operation of protection devices and to stabilize the voltage after fault isolation. The main aspects to consider when defining this requirement, as stated in [11] are as follows: priority between real and reactive current, different needs in different time periods of the fault, taking the grid topology into account, need for asymmetric contributions and consideration of technological characteristics.
Proposer	RSO
Collaboration	As stated in [11] there are no special requirements regarding TSO-TSO cooperation, but TSO-DSO cooperation is important for DCO connected PPMs. As part of coordination special care should be taken to the fact that fast fault current contribution requirement may differ depending on grid topology (meshed or radial networks)

2.1.4. System Restoration Issues

Requirement	Reconnection Capability
Network Code	RfG, Article 14(4)(a)(b)
Description	<p>The relevant TSO shall specify the conditions under which a power-generating module is capable of reconnecting to the network after an incidental disconnection caused by a network disturbance.</p> <p>According to RfG, installation of automatic reconnection systems shall be subject both to prior authorisation by the relevant system operator and to the reconnection conditions specified by the relevant TSO.</p>
Parameter(s)/ Range(s) & value(s)	<p>Conditions for reconnection to the network after an incidental disconnection caused by network disturbance</p> <p>Conditions for automatic reconnection</p>
Applicability	Type B, C and D PGM
Influencing factors/ Approach for requirement determination	<p>Voltage ranges and frequency ranges will be considered. For frequencies higher than the nominal (e.g. higher than 50.1 Hz) reconnection should not be allowed, but for frequencies lower than the nominal this would have to be a permanently allowed operating mode. There must be a hysteresis and time delay between disconnection and reconnection ranges and thresholds.</p> <p>Conditions for automatic reconnection shall be in accordance with reconnection capability. The current practice with automatic reconnection will be analyzed. The applicability of the automatic reconnection conditions to PGM types (A, B, C) will also be considered.</p>
Proposer	TSO
Collaboration	Coordination TSO-DSO (for type B and C connected on DS).

Requirement	Blackstart Capability
Network Code	RfG, Article 15(5)(a)(ii-iv)
Description	<p>RfG defines that power-generating facility owners shall, at the request of the relevant TSO, provide a quotation for providing black start capability. The relevant TSO may make such a request if it considers system security to be at risk due to a lack of black start capability in its control area.</p> <p>A power-generating module with black start capability shall be capable of starting from shutdown without any external electrical energy supply within a time frame specified by the relevant system operator in coordination with the relevant TSO.</p> <p>According to RfG, a power-generating module with black start capability shall be able to synchronize within the frequency limits and voltage limits specified by the relevant system operator.</p>
Parameter(s)/ Range(s) & value(s)	<p>Technical specifications for a quotation for black start capability</p> <p>Timeframe within which the PGM is capable of starting from shutdown without any external electrical energy supply</p> <p>Voltage limits for synchronization when article 16.2 does not apply</p>
Applicability	Type C and D PGM
Influencing factors/ Approach for requirement determination	<p>Technical specifications for black start capability contain the least:</p> <ul style="list-style-type: none"> • capability of starting from shutdown without any external electrical energy supply, • capability to operate in frequency and voltage ranges, • capability to operate in speed control mode after synchronization, • capability of parallel operation of a few power-generating modules within one island, • control voltage automatically during the system restoration phase, • maximum idle duration, <p>Technical specifications consider speed control mode will be analyzed in detail. Time for black start of typical HPP will be considered. Usually, timeframe is in the range of few minutes.</p> <p>Power-generating module with black start capability shall be able to synchronize to the network when network voltage and frequency is equal to zero. For PGM that synchronized to island, wider ranges of voltage and frequency will be considered.</p>
Proposer	TSO - RSO
Collaboration	RSO in coordination with PGFO is necessary.

Requirement	Capability of Island Operation
Network Code	RfG, Article 15(5)(b)
Description	<p>According to RfG with regard to the capability to take part in island operation:</p> <ul style="list-style-type: none"> • power-generating modules shall be capable of taking part in island operation if required by the relevant system operator in coordination with the relevant TSO and: <ul style="list-style-type: none"> ○ the frequency and voltage limits for island operation shall be those established in accordance with frequency and voltage ranges. • power-generating modules shall be able to operate in FSM during island operation. Power-generating modules shall be capable of reducing the active power output from a previous operating point to any new operating point within the P-Q-capability diagram. In regards to that, the power-generating module shall be capable of reducing active power output as much as inherently technically feasible, but at least 55 % of its maximum capacity; • the method for detecting a change from interconnected system operation to island operation shall be agreed between the power-generating facility owner and the relevant system operator in coordination with the relevant TSO. The agreed method of detection must not rely solely on the system operator's switchgear position signals; • power-generating modules shall be able to operate in LFSM-O and LFSM-U during island operation.
Parameter(s)/ Range(s) & value(s)	<p>Capability of island operation Definition of quality of supply parameters Methods and criteria for detecting island operation</p>
Applicability	Type C and D of PGM
Influencing factors/ Approach for requirement determination	<p>Wider frequency and voltage ranges will be consider. Speed control mode will be analyzed and possibilities to operate in FSM and LFSM-O and LFSM-U. FSM and LFSM-O and LFSM-U will be required for PGM of that are in parallel operation within one island.</p> <p>Quality of supply parameters in operation of PGM in island mode in terms of voltage and frequency range will be the same as the ranges in normal operation.</p> <p>Method for detecting island operation will be defined with more than two related conditions that will consider switchgear position signals, RoCoF and define threshold of actual frequency. Detecting island operation is very important for SGM, because when that operation is detected, turbine controller changes its mode from load mode to speed mode.</p>
Proposer	RSO
Collaboration	Agreed between PGM facility owner and the relevant system operator in coordination with the relevant TSO.

Requirement	Operation following Tripping to Houseload
Network Code	RfG, Article 15(5)(c)(i), 15(5)(c)(iii)
Description	<p>According to RfG in case of disconnection of the power-generating module from the network, the power-generating module shall be capable of quick re-synchronization in line with the protection strategy agreed between the relevant system operator in coordination with the relevant TSO and the power-generating facility;</p> <p>In this case, the identification of houseload operation must not be based solely on the system operator's switchgear position signals.</p> <p>Power-generating modules shall be capable of continuing operation following tripping to houseload, irrespective of any auxiliary connection to the external network. The minimum operation time shall be specified by the relevant system operator in coordination with the relevant TSO, taking into consideration the specific characteristics of prime mover technology.</p>
Parameter(s)/ Range(s) & value(s)	<p>Provision of quick re-synchronization capability.</p> <p>- A power-generating module with a minimum re-synchronization time greater than 15 minutes after its disconnection from any external power supply must be designed to trip to houseload from any operating point in its P-Q-capability diagram.</p>
Applicability	<p>Minimum operation time within which the PGM is capable of operating after tripping</p> <p>Type C and D PGM</p>
Influencing factors/ Approach for requirement determination	<p>Quick re-synchronization or trip to Houseload is depend of the PGM specific characteristics of prime mover technology. Thermal power plants are those that will have to withstand unloading trip to Houseload.</p> <p>The minimum operation time required for TSO dispatchers to respond in incident situations but not longer than the technical limits of PGM equipment.</p>
Proposer	RSO
Collaboration	Agreement between the PGFO and the RSO in coordination with the TSO.

Requirement	Active Power Recovery SPGM
Network Code	RfG, Article 17(3)
Description	With regard to robustness, type B SPGMs, and above, shall be capable of providing post-fault active power recovery. The relevant TSO shall specify the magnitude and time for active power recovery.
Parameter(s)/ Range(s) & value(s)	Definition of the magnitude and time for active power recovery
Applicability	Type B, C and D PGM
Influencing factors/ Approach for requirement determination	<p>This parameter will become increasingly important with higher penetration of renewable energy sources. For this reason, development plans will be taken into account.</p> <p>Voltage recovery after fault clearance and time for fault clearance will be considered. Network topology will be considered. Currently existing practice of displacing synchronous PGMs by PPMs will be analysed.</p>
Proposer	TSO
Collaboration	Coordination TSO - PPM owner.

Requirement	Post Fault Active Power Recovery PPM
Network Code	RfG, Article 20(3)(a)
Description	<p>Type B power park modules, and above, shall fulfil the following additional requirements in relation to robustness:</p> <ul style="list-style-type: none"> • the relevant TSO shall specify the post-fault active power recovery that the power park module is capable of providing and shall specify: <ul style="list-style-type: none"> ○ when the post-fault active power recovery begins, based on a voltage criterion; ○ a maximum allowed time for active power recovery; and ○ a magnitude and accuracy for active power recovery
Parameter(s)/ Range(s) & value(s)	<p>Specification when the post- fault active power recovery begins.</p> <p>Specification of the maximum allowed time for active power recovery.</p> <p>Specification of magnitude and accuracy for active power recovery.</p>
Applicability	Type B, C and D PGM
Influencing factors/ Approach for requirement determination	<p>This parameter will become increasingly important with higher penetration of renewable energy sources. For this reason, development plans will be taken into account.</p> <p>Voltage recovery after fault clearance and time for fault clearance will be considered. Network topology will be consider. Technical capabilities of PPMs will be analysed.</p>
Proposer	TSO
Collaboration	Coordination TSO - PPM owner.

2.1.5. Instrumentation, Simulation Models and Protections Issues

Requirement	Control and Protection Scheme and Settings
Network Code	RfG, Article 14(5)(a-b)
Description	<p>Control schemes and settings of different PGM control devices that are necessary in order to ensure system stability and for taking emergency actions need to be coordinated between RSO, relevant TSO and PGFO. Same coordination is also required in the case when there are some changes to schemes or settings of before mentioned devices.</p> <p>As in the case of control device settings any changes to protection schemes and setting need to be agreed between RSO and PGFO, before any changes are made.</p>
Parameter(s)/ Range(s) & value(s)	<p>Requirements for protection function necessary to protect network.</p> <p>Protection scheme and settings needed for PGM and network coordination (RSO-PFGO)</p>
Applicability	Type B, C and D PGMs
Influencing factors/ Approach for requirement determination	<p>The requirements for protection function necessary to protect network should be made by taking into account PGM characteristics.</p> <p>In case of the protection functions, providing protection from PGM internal faults, employed schemes and its settings must not jeopardize PGM’s performance as requested by other requirements.</p> <p>The requirement is going to be dictated by the RSO employed protection philosophy, and as pointed out in [7] site specific requirements should be implemented and agreed upon in due time for plant design or commissioning at latest.</p>
Proposer	RSO
Collaboration	Collaboration and agreement between RSO and PFGO is crucial

Requirement	Instrumentation
Network Code	RfG, Article 15(6)(b)(ii-iv)
Description	<p>PGM facilities shall be capable of fault recording and monitoring of dynamic system behaviour.</p> <p>PGM facilities should record: voltage, active and reactive power and frequency</p> <p>Facilities for recording quality of supply and dynamic system behaviour should enable RSO, PGFO, and relevant TSO to access the recorded data</p>
Parameter(s)/ Range(s) & value(s)	<p>Quality of supply parameters</p> <p>Triggering criteria</p> <p>Sample rate</p> <p>Communication protocols to be used for fault record data</p>
Applicability	Type C and D PGMs
Influencing factors/ Approach for requirement determination	Special attention should be paid for triggering criteria and sample rate in the case of dynamic system behaviour monitoring, in order to detect poorly damped power oscillations.
Proposer	RSO
Collaboration	Collaboration and agreement between RSO, relevant TSO and PFGO is crucial

Requirement	Simulation models
Network Code	RfG, Article 15(6)(c)(i), 15(6)(c)(iii - iv)
Description	<p>PGFO is obligated to provide simulation models, that accurately describe PGM's steady state and dynamical behaviour or the model to be used in electromagnetic transient simulation, at the request of RSO or the relevant TSO.</p> <p>These models should be verified against results of compliance tests.</p>
Parameter(s)/ Range(s) & value(s)	<p>Possibility to request from PGFO PGM's response recordings that can be used to compare PGM simulated response to provided recordings.</p> <p>Format in which models should be provided and requests regarding model documentation (e.g. structure and block diagram description etc.).</p>
Applicability	Type C and D PGMs
Influencing factors/ Approach for requirement determination	<p>Regarding model verification, RfG leaves the possibility to the EnC contracting party to request that model verification is carried out by authorized certifier.</p> <p>Regarding model format the decision will depend on RSO's and relevant TSO's existing practice, i.e. which software package is currently in use. Also it is good practice to require from PGFO to deliver simulation model in one of the standardize form (either IEC or IEEE standard models). Besides the fact that these types of models are implemented and supported by relevant software packages, the standardization of models facilitates integration of models between TSO and DSO or TSOs in order to perform larger studies. In the case that adequate response could not be achieved using one of the standardize models PGFO should be granted to deliver custom model with detailed model documentation.</p> <p>Model documentation is very important especially in the case of not standardized models. Every block should be properly explained, and structure of complex blocks or subsystems should be provided.</p>
Proposer	RSO
Collaboration	Collaboration and agreement between RSO, relevant TSO and PGFO is crucial

<p>Requirement</p> <p>Network Code</p>	<p>Other requirements</p> <p>RfG, Article 15(6)(d), 15(6)(f), 16(2)(c), 16(4)(d), 19(3), 21(2)</p>
<p>Parameter(s)/ Range(s) & value(s)</p>	<p><u>Information exchange</u></p> <p>Manner in which real time information is exchanged between power generating facility and RSO or the relevant TSO,</p> <p>Content of exchanged information.</p> <p>This requirement is applicable to type B, C and D PGMs, and is site specific requirement.</p> <p><u>Disconnection from grid caused by angular instability or loss of control</u></p> <p>Criteria for detecting conditions, for which PGM should automatically disconnect from the grid in order to help preserve system security or damage to PGM, the case of loss of angular stability or loss of control. Applicable to type C and D PGMs.</p> <p><u>Additional devices to be installed in power generating facility in order to preserve or restore system operation or security</u></p> <p>Additional devices to be installed in power generating facility. This site specific requirement is applicable to type C and D PGMs</p> <p><u>Step up transformer HV side neutral point earthing type</u></p> <p>Regarding earthing arrangement of step-up transformer HV winding’s neutral point PFGO shall comply with RSO’s specifications. This site specific requirement applicable to type C and D PGMs.</p> <p><u>Synchronization device</u></p> <p>Synchronization device’s setting regarding:</p> <ul style="list-style-type: none"> • voltage, • frequency, • phase angle range, • phase sequence and • deviation of voltage and frequency. <p>Applicable to type D PGMs.</p> <p><u>Synthetic inertia</u></p> <p>Operating principle of control systems installed to provide synthetic inertia and associated performance parameters. Not mandatory requirements applicable to type C and D PPMs.</p>

2.2. DCC Non-Exhaustive Requirements

2.2.1. Frequency Issues

Requirement	Frequency Ranges												
Network Code	DCC, Article 12(1)(2)												
Description	<p>Frequency ranges requirement defines frequency ranges and time periods for which transmission-connected demand facilities (TC DF), transmission-connected distribution facilities and distribution systems (TC DS) have to be capable of remaining connected to the network and continue to operate stably. This time periods represent the minimum time periods for which TC DF and TC DS have to remain connected to the network.</p> <p>Potential wider frequency ranges or longer minimum time periods might be agreed between the transmission-connected demand facility owner or the DSO and relevant TSO.</p> <p>Time period for which TC DF and TC DS shall be capable of remaining connected to the network and operate within defined frequency ranges.</p>												
Parameter(s)/ Range(s) & value(s)	<table border="1"> <thead> <tr> <th>Synchronous area</th> <th>Frequency range</th> <th>Time period for operation</th> </tr> </thead> <tbody> <tr> <td rowspan="4">Continental Europe</td> <td>47.5 Hz-48.5 Hz</td> <td>To be specified by each TSO. but not less than 30 minutes</td> </tr> <tr> <td>48.5 Hz-49.0 Hz</td> <td>To be specified by each TSO. but not less than the period for 47.5 Hz-48.5 Hz</td> </tr> <tr> <td>49.0 Hz-51.0 Hz</td> <td>Unlimited</td> </tr> <tr> <td>51.0 Hz-51.5 Hz</td> <td>30 minutes</td> </tr> </tbody> </table>	Synchronous area	Frequency range	Time period for operation	Continental Europe	47.5 Hz-48.5 Hz	To be specified by each TSO. but not less than 30 minutes	48.5 Hz-49.0 Hz	To be specified by each TSO. but not less than the period for 47.5 Hz-48.5 Hz	49.0 Hz-51.0 Hz	Unlimited	51.0 Hz-51.5 Hz	30 minutes
Synchronous area	Frequency range	Time period for operation											
Continental Europe	47.5 Hz-48.5 Hz	To be specified by each TSO. but not less than 30 minutes											
	48.5 Hz-49.0 Hz	To be specified by each TSO. but not less than the period for 47.5 Hz-48.5 Hz											
	49.0 Hz-51.0 Hz	Unlimited											
	51.0 Hz-51.5 Hz	30 minutes											
Applicability	<p>Wider frequency ranges and/or longer minimum time periods might be agreed between the transmission-connected demand facility owner or the DSO and relevant TSO.</p> <p>TC DF, TC DS</p>												
Influencing factors/ Approach for requirement determination	<p>The necessary time periods will be defined such that system collapse is avoided in case of an emergency situation as well as that TC DF and TC DS remain connected during the black start operation mode. When defining these time periods it will be take into account current technology characteristic being used in TC DF and TC DS as well as frequency ranges and time periods defined for power generating modules.</p> <p>Good starting point when determining wider frequency ranges and/or longer times periods is to analyse black start operation and U/f characteristic of PGMs providing black start ancillary services.</p>												
Proposer	Relevant TSO												
Collaboration	Regional cooperation between TSOs is important and necessary when defining this requirement.												

Requirement	Demand Response (1 of 5)
Network Code	DCC, Article 28(2)(5)
Description	<p>Demand units with DR active power control, DR reactive power control, or DR transmission constraint management have to be capable of staying connected to the network due to the rate-of-change-of-frequency (RoCoF) that does not exceed a value specified by the relevant TSO. The RoCoF has to be measured over a 500ms time frame.</p> <p>DUs offering DR should comply with the requirements, either individually or, collectively as part of demand aggregation through a third party It should be noted, that all requirements that have to be defined by RSO/TSO and that are related to the demand units with DR and connected at voltage level below 110kV, have to be subjected to consultation with the relevant stakeholders in accordance with Article 9(1) of DCC, prior to approval in accordance with Article 6 of DCC.</p> <p>Having in mind that providing DR is not mandatory for DF and CDS, all the requirements related to DR are non-mandatory and can be applied only if DFs and CDs are capable of providing any of demand response services.</p>
Parameter(s)/ Range(s) & value(s)	Rate of change of frequency withstand over a 500ms time period.
Applicability	DF and CDS offering DR
Influencing factors/ Approach for requirement determination	In order to be determined the RoCoF, some existing transmission network disturbance will be taken into account and analysed. Development plans in terms of penetration of non-synchronous renewable generation will be taken into account.
Proposer	Relevant TSO
Collaboration	The relevant system operator needs to take care that the parameters of RoCoF withstand capability defined by the relevant TSO are applied to system users.

Requirement	Demand Response (2 of 5)
Network Code	DCC, Article 29(2)(c)
Description	For demand units with DR system frequency control that are connected at voltage levels below 110kV, RSO has to specify the normal operational voltage range of the system at the connection point. RSO has to specify this voltage range by taking into account existing standards. Demand units with DRS SFC have to be capable of operating within specified voltage range.
Parameter(s)/ Range(s) & value(s)	For DU connected below 110 kV: Definition of the normal operating range.
Applicability	DF and CDS offering DR
Influencing factors/ Approach for requirement determination	Having in mind that for each RSO wider voltage ranges are desirable normal operational voltage range will be determined thus balance between RSO needs and equipment capabilities will be found.
Proposer	RSO
Collaboration	When defining before mentioned requirement coordination between RSO and Grid Users is necessary.

Requirement	Demand Response (3 of 5)
Network Code	DCC, Article 29(2)(d)
Description	Since the demand units with DR SFC have to be equipped with a control system that is insensitive within a dead-band around the nominal system frequency of 50.00 Hz, relevant TSO in consultation with the TSOs in the synchronous area has to define the width of this dead-band.
Parameter(s)/ Range(s) & value(s)	Definition of the allowed frequency dead-band.
Applicability	DF and CDS offering DR
Influencing factors/ Approach for requirement determination	The frequency dead-band will be determined thus the demand response is activated at full deployment of FCR. It will be considered that there is no gap between full deployment of the FCR and activation of the demand response.
Proposer	Relevant TSO
Collaboration	As stated in DCC Article 29(2)(d) relevant TSO has to define this requirement in consultation with the TSOs in the synchronous area.

Requirement	Demand Response (4 of 5)
Network Code	DCC, Article 29(2)(e)
Description	The relevant TSO in coordination with the TSOs in the synchronous area has to specify the maximum frequency deviation from nominal value of 50.00 Hz for which demand units with DR SFC have to respond to.
Parameter(s)/ Range(s) & value(s)	Definition of the frequency ranges for DRS System Frequency Control (SFC). Definition of the maximum frequency deviation to respond.
Applicability	DF and CDS offering DR
Influencing factors/ Approach for requirement determination	The maximum frequency deviation refers to frequency thresholds at which shedding of non-essential loads should be activated. Therefore, the under frequency threshold will be determined in such a way that in the case of under frequency deviation shedding of non-essential loads is deployed before the LFDD is operated. The over frequency threshold will be determined so that significant loss of inertia is avoided.
Proposer	Relevant TSO
Collaboration	As stated in DCC Article 29(2)(d) relevant TSO has to define this requirement in consultation with the TSOs in the synchronous area.

Requirement	Demand Response (5 of 5)
Network Code	DCC, Article 29(2)(g)
Description	The demand unit shall be capable of rapid detection and response to changes in system frequency to be specified by the relevant TSO, in coordination with other TSOs in the synchronous area. Demand units should be able to detect a change in system frequency of 0.01 Hz, where an offset in the steady-state measurement of frequency shall be acceptable up to 0.05 Hz. As further explained in [14] this requirement dictates that every unit should be capable to measure the nominal frequency with an offset of up to ± 50 mHz, but after this offset is accounted for each device will be accurate to within 10 mHz across its response.
Parameter(s)/ Range(s) & value(s)	Definition of the rapid detection of frequency system changes. Definition of the response to frequency system changes.
Applicability	DF and CDS offering DR
Influencing factors/ Approach for requirement determination	By defining admissible frequency offset of sensor of the system frequency, current technological capabilities will be taken into account and also it will be endeavoured that prices of sensor of the system frequency stay in the reasonable range.
Proposer	Relevant TSO
Collaboration	As stated in DCC Article 29(2)(e) relevant TSO has to define this requirement in consultation with the TSOs in the synchronous area.

2.2.2. Voltage Issues

Requirement	Voltage Ranges																
Network Code	DCC, Article 13(1)(7)																
Description	<p>DCC defines requirements for transmission-connected demand facilities, transmission-connected distribution facilities and transmission-connected distribution systems, regarding minimum time period that the TC DF and TC DS should be capable to staying connected to the network and operate, as a function of voltage level at the connection point.</p> <p>With regard to TC DS with connection point below 110 kV, relevant TSO has to specify the voltage range at the connection point that the DSs connected to that transmission system shall be designed to withstand.</p> <p>Time period for which TC DF and TC DS shall be capable to stay connected to the grid for upper voltage range at the connection point between.</p> <p><i>Table 15 - Minimum time periods during which TC DF and TC DS must be capable of operating without disconnecting from the network, for grid of nominal voltage level from 110 kV to 300 kV</i></p> <table border="1"> <thead> <tr> <th>Synchronous area</th> <th>Voltage range</th> <th>Time period for operation</th> </tr> </thead> <tbody> <tr> <td rowspan="2">Continental Europe</td> <td>0.90 pu-1.118 pu</td> <td>Unlimited</td> </tr> <tr> <td>1.118 pu-1.15 pu</td> <td>To be specified by each TSO but not less than 20 minutes and not more than 60 minutes</td> </tr> </tbody> </table> <p><i>Table 16 - Minimum time periods during which TC DF and TC DS must be capable of operating without disconnecting from the network, for grid of nominal voltage level from 300 kV to 400 kV (including)</i></p> <table border="1"> <thead> <tr> <th>Synchronous area</th> <th>Voltage range</th> <th>Time period for operation</th> </tr> </thead> <tbody> <tr> <td rowspan="2">Continental Europe</td> <td>0.90 pu-1.05 pu</td> <td>Unlimited</td> </tr> <tr> <td>1.05 pu-1.10 pu</td> <td>To be specified by each TSO but not less than 20 minutes and not more than 60 minutes</td> </tr> </tbody> </table>	Synchronous area	Voltage range	Time period for operation	Continental Europe	0.90 pu-1.118 pu	Unlimited	1.118 pu-1.15 pu	To be specified by each TSO but not less than 20 minutes and not more than 60 minutes	Synchronous area	Voltage range	Time period for operation	Continental Europe	0.90 pu-1.05 pu	Unlimited	1.05 pu-1.10 pu	To be specified by each TSO but not less than 20 minutes and not more than 60 minutes
Synchronous area	Voltage range	Time period for operation															
Continental Europe	0.90 pu-1.118 pu	Unlimited															
	1.118 pu-1.15 pu	To be specified by each TSO but not less than 20 minutes and not more than 60 minutes															
Synchronous area	Voltage range	Time period for operation															
Continental Europe	0.90 pu-1.05 pu	Unlimited															
	1.05 pu-1.10 pu	To be specified by each TSO but not less than 20 minutes and not more than 60 minutes															
Parameter(s)/ Range(s) & value(s)																	
Applicability	TC DF and TC DC																
Influencing factors/ Approach for requirement determination	Having in mind that for each TSO longer time periods are desirable, these time period will be determined thus balance between TSOs needs and equipment capabilities will be found. Also, the type of actions available to the TSO will be taken into consideration.																
Proposer	TSO																
Collaboration	<p>As stated in [8] cooperation between TSOs regarding voltage ranges is needed in cases where more than one TSO operates in same country or between TSOs from interconnected countries. This is important because higher normal operating ranges in one country may create similarly higher voltages that could be beyond the specified range in adjacent network, or lead to excessive reactive power transit over interconnections.</p> <p>Also as stated at [8] TSO-DSO cooperation may be necessary regarding requirements for voltage ranges, as well as time period the facilities should be capable of operating under these conditions.</p>																

Requirement	Automatic disconnection due to voltage level
Network Code	DCC, Article 13(6)
Description	DCC defines that TC DF and TC DS have to be capable of automatic disconnection at specified voltages. This requirement could be required by relevant TSO, whereby relevant TSO in that case, has to specify voltages on which automatic disconnection is required.
Parameter(s)/ Range(s) & value(s)	Voltage criteria parameters at the connection point for automatic disconnection. Technical parameters at the connection point for automatic disconnection.
Applicability	TC DF and TC DC (non-mandatory)
Influencing factors/ Approach for requirement determination	The voltage criteria for automatic disconnection will be defined depending on whether TC DF or TC DS contributes actively to voltage regulation or not.
Proposer	Relevant TSO
Collaboration	The terms and settings for automatic disconnection shall be agreed between the relevant TSO and the transmission-connected demand facility owner or the DSO.

Requirement	Reactive power capability for TC DF and TC DS (1 of 2)
Network Code	DCC, Article 15(1)(a)(b)(c)(d)
Description	<p>For TC DF the actual reactive power range specified by relevant TSO for production and consumption of reactive power at maximum capacity shall not be wider than 48 percent (i.e. $\max\{Q/P_{\max}\} \leq 0.48$), corresponding to power factor of 0.9. Exception could be made if the TC DF owner demonstrates that other ranges provide either technical or financial system benefits and relevant TSO accepts the proposal.</p> <p>For TC DS the actual reactive power production and consumption at maximum capacity shall not be wider than 48 percent (i.e. 0,9 power factor). Here exception could also be made if the relevant TSO and the transmission-connected DSO through joint analysis show that other ranges provide either technical or financial system benefits.</p> <p>DCC also defines that relevant TSO and TC DSO have to agree on the scope of the analysis which will address the possible solutions, and determine the optimal solution for reactive power exchange between their systems. The analysis have to take into account specific system characteristics, variable structure of power exchange, bidirectional flows and the reactive power capabilities in the distribution system.</p> <p>As a non-mandatory requirement DCC provides TSO with possibility to establish the use of metrics other than power factor in order to set out equivalent reactive power capability ranges. In either case reactive power requirement is expressed at connection point of the facility.</p>
Parameter(s)/ Range(s) & value(s)	<p>Definition of the actual reactive power range for TC DF and TC DS with onsite generation.</p> <p>Definition of the scope of the analysis to find the optimal solution for reactive power.</p> <p>Definition of other metrics than power factor.</p>
Applicability	TC DF and TC DC
Influencing factors/ Approach for requirement determination	The actual reactive power range at TSO-DSO and TSO-DF interface will be defined so that overall system optimum in terms of reactive power is achieved. Current and foreseeable future characteristics of network will be taken into account as well as planned transition of generation for transmission to distribution network. Also, the experience from the relevant TSOs will be taken into account.
Proposer	Relevant TSO
Collaboration	Regarding implementation of this requirement limited TSO-TSO collaboration is expected. On the other hand TSO and DSOs (including CDSO) collaboration is of utmost importance. For example, as pointed out in [15] in certain situations TSOs and DSOs can see added value in aggregation of connection points between TSO and DSO, and regrouping connection points in zones, for which reactive power requirements will be set, instead defining it for each of the connection point separately.

Requirement	Reactive power capability for TC DF and TC DS (2 of 2)
Network Code	DCC, Article 15(2)(3)(4)
Description	<p>According to DCC, relevant TSO may require that TC DS is capable not to export, i.e. produce reactive power (at reference 1 pu voltage) at an active power flow of less than 25% of the maximum import capability. EnC contracting party may require that relevant TSO, justify this request through a joint analysis with the TC DSO.</p> <p>Even though, as pointed out in [15] a core principle that should underpin all TSO & DSOs interactions with regard to reactive power is that each system operator is responsible for ensuring voltage requirements on its network, relevant TSO may require from TC DSO, to actively control the exchange of reactive power at the connection point, in order to achieve benefit to entire system. In this case relevant TSO and TC DSO should agree on a control method in order to ensure the justified level of security of supply for both parties. Furthermore, DCC defines that TC DSO may require from the relevant TSO to consider its transmission-connected distribution system for reactive power management.</p>
Parameter(s)/ Range(s) & value(s)	<ul style="list-style-type: none"> • Reactive power capability for transmission connected distribution systems not to export reactive power at less than 25% of the maximum import capability. • Method to carry out active control of the exchange of reactive power at the connection point. • Consideration of TC DS for reactive power management.
Applicability	TC DC (non-mandatory)
Influencing factors/ Approach for requirement determination	The actual reactive power range at TSO-DSO and TSO-DF interface will be defined so that overall system optimum in terms of reactive power is achieved. Current and foreseeable future characteristics of networks will be taken into account as well as planned transition of generation for transmission network to distribution network. Also, the experience from the relevant TSOs will be taken into account.
Proposer	Relevant TSO
Collaboration	Regarding implementation of this requirement limited TSO-TSO collaboration is expected. On the other hand TSO and DSOs (including CDSO) collaboration is of utmost importance. For example, as pointed out in [15] in certain situations TSOs and DSOs can see added value in aggregation of connection points between TSO and DSO, and regrouping connection points in zones, for which reactive power requirements will be set, instead for each of the connection point separately.

Requirement	Demand Response
Network Code	DCC, Article 28(2)(e)(f)(i)
Description	RSO or relevant TSO defines time period for which DUs shall be capable of adjusting its power consumption. Also RSO or relevant TSO shall specify modality in which DU is to notify it regarding any modification to DU’s demand response capacity.
	Regarding general demand response requirements DU with DR should be equipped to receive instructions, directly or indirectly through a third party, from the RSO or the relevant TSO to modify their demand and also to be able to transfer the necessary information. The relevant system operator shall make publicly available the approved technical specifications regarding the information exchange.
	For all requirements/specification applicable to DUs connected at a voltage level below 110 kV, specifications shall, prior to approval in accordance with Article 6, be subject to consultation with the relevant stakeholders in accordance with Article 9(1).
Parameter(s)/ Range(s) & value(s)	For DF or CDS connected below 110 kV: Definition of the normal operating range.
	Technical specifications to enable the transfer of information for DR LFDD and Low Voltage Demand Disconnection (LVDD), for DR Active Power Control (APC) and DR Reactive Power Control.
	Definition of the time period to adjust the power consumption.
Applicability	Definition of the modalities of notification in case of a modification of the DR capability.
	Definition of the ROCOF maximum value.
	DU offering DR (non-mandatory)
Influencing factors/ Approach for requirement determination	Operating ranges for voltage and frequency, and max value of RoCoF should be identical to those for PGMs. The existing characteristics of the DRS that can control reactive power will be taken into account.
Proposer	RSO or relevant TSO
Collaboration	Coordination between RSO and DU owner is necessary.

Requirement	Power quality
Network Code	DCC, Article 20
Description	With regard to power quality DCC defines that TC DF owner and TC DS operator have to ensure that level of distortion or fluctuation of the supply voltage at the connection point does not exceed level determined by relevant TSO.
Parameter(s)/ Range(s) & value(s)	Allocated level of voltage distortion.
Applicability	TC DF and TC DC
Influencing factors/ Approach for requirement determination	The relevant national and international standards related to power quality will be taken into account.
Proposer	Relevant TSO
Collaboration	Regarding implementation of this requirement TSO-TSO collaboration is expected since according to DCC, each TSO shall coordinate their power quality requirements with the requirements of adjacent TSOs.

2.2.3. System Restoration Issues

<p>Requirement</p> <p>Network Code</p>	<p>Short circuit requirements (1 of 2)</p> <p>DCC, Article 14(1)(2)(3)(5)(8)(9)</p>
<p>Description</p>	<p>Based on the rated short-circuit withstand capability of its transmission network elements, the relevant TSO shall specify the maximum short-circuit current at the connection point that the transmission-connected demand facility or the transmission-connected distribution system shall be capable of withstanding.</p> <p>The relevant TSO shall deliver to the transmission-connected demand facility owner or the transmission-connected distribution system operator an estimate of the minimum and maximum short-circuit currents to be expected at the connection point as an equivalent of the network.</p> <p>After an unplanned event, the relevant TSO shall inform the affected transmission-connected demand facility owner or the affected transmission-connected distribution system operator as soon as possible and no later than one week after the unplanned event, of the changes above a threshold for the maximum short-circuit current that the affected transmission-connected demand facility or the affected transmission-connected distribution system shall be able to withstand from the relevant TSO's network in accordance with paragraph 1.</p> <p>Before a planned event, the relevant TSO shall inform the affected transmission-connected demand facility owner or the affected transmission-connected distribution system operator, as soon as possible and no later than one week before the planned event, of the changes above a threshold for the maximum short-circuit current that the affected transmission-connected demand facility or the affected transmission-connected distribution system shall be able to withstand from the relevant TSO's network, in accordance with paragraph 1.</p> <p>After an unplanned event, the transmission-connected demand facility owner or the transmission-connected distribution system operator shall inform the relevant TSO, as soon as possible and no later than one week after the unplanned event, of the changes in short-circuit contribution above the threshold set by the relevant TSO.</p> <p>Before a planned event, the transmission-connected demand facility owner or the transmission-connected distribution system operator shall inform the relevant TSO, as soon as possible and no later than one week before the planned event, of the changes in short-circuit contribution above the threshold set by the relevant TSO.</p>
<p>Parameter(s)/ Range(s) & value(s)</p>	<p>Maximum short- circuit current at the connection point to be withstood</p> <p>An estimate of the minimum and maximum short- circuit currents to be expected at the connection point as an equivalent of the network</p> <p>Unplanned events: threshold of the maximum short circuit current inducing an information from the TSO in case of a change above this threshold</p> <p>Planned events: threshold of the maximum short circuit current inducing an information from the TSO in case of a change above this Threshold</p>

Requirement	Short circuit requirements (2 of 2)
Parameter(s)/ Range(s) & value(s)	Unplanned events: threshold of the maximum short circuit current inducing an information from the TC DF or TC DSO in case of a change above this threshold Planned events: threshold of the maximum short circuit current inducing an information from the TC DF or TC DSO in case of a change above this threshold
Applicability	TC DF and TC DC
Influencing factors/ Approach for requirement determination	These requirements are site specific and there are no general values to be specified. A specific procedure, with defined deadlines, will be proposed after analysing the current practice of TSO - DSO - TC DF regarding to short-circuit withstand capability of DU.
Proposer	Relevant TSO
Collaboration	Collaboration between the relevant TSO and TC DF or DC DS is expected.

Requirement	Demand disconnection for system defence (1 of 3)
Network Code	DCC, Article 19(1)(a), 19(1)(c), 19(2)(a), 19(2)(b), 19(2)(c), 19(2)(d), 19(3), 19(4)
Description	<p>All transmission-connected demand facilities and transmission-connected distribution systems shall fulfil the following requirements related to low frequency demand disconnection functional capabilities:</p> <ul style="list-style-type: none"> • each transmission-connected distribution system operator and, where specified by the TSO, transmission-connected demand facility owner, shall provide capabilities that enable automatic ‘low frequency’ disconnection of a specified proportion of their demand. The relevant TSO may specify a disconnection trigger based on a combination of low frequency and rate-of-change-of-frequency; • the low frequency demand disconnection functional capabilities shall allow for operation from a nominal Alternating Current (‘AC’) input to be specified by the relevant system operator, and shall meet the following requirements: <ul style="list-style-type: none"> ○ frequency range: at least between 47-50 Hz, adjustable in steps of 0,05 Hz; ○ operating time: no more than 150 ms after triggering the frequency setpoint; ○ voltage lock-out: blocking of the functional capability shall be possible when the voltage is within a range of 30 to 90 % of reference 1 pu voltage; ○ provide the direction of active power flow at the point of disconnection; <p>With regard to low voltage demand disconnection functional capabilities, the following requirements shall apply:</p> <ul style="list-style-type: none"> • the relevant TSO may specify, in coordination with the transmission-connected distribution system operators, low voltage demand disconnection functional capabilities for the transmission-connected distribution facilities; • the relevant TSO may specify, in coordination with the transmission-connected demand facility owners, low voltage demand disconnection functional capabilities for the transmission-connected demand facilities; • based on the TSO's assessment concerning system security, the implementation of on load tap changer blocking and low voltage demand disconnection shall be binding for the transmission-connected distribution system operators; <p>(if the relevant TSO decides to implement a low voltage demand disconnection functional capability, the equipment for both on load tap changer blocking and low voltage demand disconnection shall be installed in coordination with the relevant TSO;</p>

Requirement	<p>Demand disconnection for system defence (2 of 3)</p> <p>With regard to blocking of on load tap changers, the following requirements shall apply:</p> <ul style="list-style-type: none"> • if required by the relevant TSO, the transformer at the transmission-connected distribution facility shall be capable of automatic or manual on load tap changer blocking; • the relevant TSO shall specify the automatic on load tap changer blocking functional capability. <p>All transmission-connected demand facilities and transmission-connected distribution systems shall fulfil the following requirements related to disconnection or reconnection of a transmission-connected demand facility or a transmission-connected distribution system:</p>
Description	<ul style="list-style-type: none"> • with regard to the capability of reconnection after a disconnection, the relevant TSO shall specify the conditions under which a transmission-connected demand facility or a transmission-connected distribution system is entitled to reconnect to the transmission system. Installation of automatic reconnection systems shall be subject to prior authorization by the relevant TSO; • with regard to reconnection of a transmission-connected demand facility or a transmission-connected distribution system, the transmission-connected demand facility or the transmission-connected distribution system shall be capable of synchronization for frequencies within the ranges set out in Article 12. The relevant TSO and the transmission-connected demand facility owner or the transmission-connected distribution system operator shall agree on the settings of synchronization devices prior to connection of the transmission-connected demand facility or the transmission-connected distribution system, including voltage, frequency, phase angle range and deviation of voltage and frequency; • a transmission-connected demand facility or a transmission-connected distribution facility shall be capable of being remotely disconnected from the transmission system when required by the relevant TSO. If required, the automated disconnection equipment for reconfiguration of the system in preparation for block loading shall be specified by the relevant TSO. The relevant TSO shall specify the time required for remote disconnection.

Requirement	<p>Demand disconnection for system defence (1 of 2)</p> <p>Definition the capabilities of Low Frequency Demand Disconnection (LFDD) scheme</p> <p>Frequency range: at least between 47-50 Hz, adjustable in steps of 0,05 Hz; Operating time: no more than 150 ms after triggering the frequency setpoint; Voltage lock-out: blocking of the functional capability shall be possible when the voltage is within a range of 30 to 90 % of reference 1 pu voltage; Provide the direction of active power flow at the point of disconnection;</p> <p>Definition of the LVDD scheme</p> <p>Implementation of on load tap changer blocking and low voltage demand disconnection</p>
Parameter(s)/ Range(s) & value(s)	<p>Equipment for both on load tap changer blocking and low voltage demand disconnection coordination</p> <p>Requirement of automatic or manual on load tap changer blocking</p> <p>Definition of the automatic on load tap changer blocking scheme</p> <p>Definition of the conditions for reconnection after a disconnection</p> <p>Settings of the synchronization devices (including frequency, voltage, phase angle range and deviation of voltage and frequency)</p> <p>Definition of the automated disconnection equipment</p> <p>Time for remote disconnection</p>
Applicability	<p>TC DF and TC DS or only to TC Ds</p>
Influencing factors/ Approach for requirement determination	<p>Requirements regarding to demand disconnection for system defence will be defined considering:</p> <ul style="list-style-type: none"> • system defence plan, • FSM of PGMs • automatic disconnection of PGMs due to Voltage Level • current practice of TSO - DSO - TC DF regarding to system defence.
Proposer	<p>Relevant TSO</p>
Collaboration	<p>Collaboration between the relevant TSO and TC DF or DC DS is expected.</p>

2.2.4. Instrumentation, Simulation Models and Protections Issues

Requirement	Control and Protection Scheme and Settings
Network Code	DCC, Article 16(1), Article (17)(1)
Description	<p>Relevant TSO has to specify electrical protection scheme and settings in terms of protecting the transmission network considering TC DF and TC DS characteristics. Electrical protection schemes and settings relevant for the TC DF or the TC DS, have to be determined by an agreement between the relevant TSO and the TC DF owner or the TC DS operator.</p> <p>Schemes and settings of the different control devices relevant for system security that needs to be installed in the TC DF or the TC DS, have to be determined by an agreement between relevant TSO and the TC DF owner or the TC DS operator. Also, relevant TSO and TC DF owner or the TC DSO shall agree on any changes to the protection schemes relevant for TC DF or TC DS</p> <p>Protection scheme devices may cover the following elements:</p> <ul style="list-style-type: none"> • external and internal short circuit; • over- and under-voltage at the connection point to the transmission system; • over- and under-frequency; • demand circuit protection; • unit transformer protection; • back-up against protection and switchgear malfunction.
Parameter(s)/ Range(s) & value(s)	<p>Requirements for protection function necessary to protect network.</p> <p>Protection scheme and settings relevant for TC DF and TC DS (to be determined by an agreement)</p> <p>Control devices scheme and settings needed for system security reasons (to be determined by an agreement)</p>
Applicability	TC DF and TC DS
Influencing factors/ Approach for requirement determination	The requirement is going to be dictated by the TSO/DSO employed protection philosophy, and site specific requirements should be implemented and agreed upon in due time.
Proposer	Relevant TSO
Collaboration	Collaboration and agreement between relevant TSO and DSO/TC DF owner

Requirement	Simulation models
Network Code	DCC, Article 21
Description	<p>Each TSO may require simulation models or equivalent information showing the behaviour of the TC DF or the TC DS in steady and dynamic states.</p> <p>In order for TC DF and TC DS to be able to provide the necessary simulation models and information, each TSO has to specify the content and format of those simulation models or equivalent information.</p>
Parameter(s)/ Range(s) & value(s)	<p>Simulation models' content and format, including:</p> <ul style="list-style-type: none"> • steady and dynamic states, including 50 Hz component, • electromagnetic transient simulations at the connection point, • structure and block diagrams <p>Additionally, for the purpose of dynamic simulations, the simulation model or equivalent information also have to include the following:</p> <ul style="list-style-type: none"> • power control, • voltage control, • transmission-connected demand facility and transmission-connected distribution system protection models, • the different types of demand, that is to say electro technical characteristics of the demand, • converter models <p>Requirements for model performance estimations</p>
Applicability	TC DF and TC DS
Influencing factors/ Approach for requirement determination	In order to compare the response of above mentioned simulations models with the recordings from transmission-connected demand facilities or transmission-connected distribution facilities, each RSO or relevant TSO has to specify the requirements of the performance of these recordings.
Proposer	Relevant TSO
Collaboration	TSO/DSO

Requirement	Information Exchanges
Network Code	DCC, Article 18
Description	<p>The relevant TSO has to specify the information exchange standards, and the precise list of data with the specified time stamping required to be exchanged with the TC DF and the TC DS. This information should be publicly available.</p> <p>On the other hand, TC DF and TC DS have to be equipped in such a way that they are capable to exchange information with the relevant TSO in accordance with defined requirements.</p>
Parameter(s)/ Range(s) & value(s)	<p>Information exchange standards</p> <p>List of data with the specified required time stamping to be exchanged</p>
Applicability	TC DF and TC DS
Influencing factors/ Approach for requirement determination	Main determining factor is current and planned state of TSO regarding communication infrastructure.
Proposer	Relevant TSO
Collaboration	TSO/DSO

3. Gap analysis

3.1. Electricity power system general overview

In Moldova, there are three entities that are important in terms of implementing network codes:

- Agency - National Agency for Energy Regulation of the Republic of Moldova (hereinafter, "ANRE");
- DSO, there is 8 distribution operators in Moldova, and
- TSO - State Enterprise Moldelectrica, the transmission system operator for electricity in the Republic of Moldova.

According to [16], the **Agency** regulates and monitors competencies in the energy sector.

Competencies of the Agency [16]:

- approves Technical rules of the electricity networks and monitors their implementation by system operator, together with the obligation to maintain electricity networks;
- approves Regulation on Connection to the Electricity Networks and Rendering Electricity Transmission and Distribution Services (hereinafter - Regulation on Connection) which establishes the terms and conditions of connection, disconnection from and re-connection to the electricity networks, including electricity plants, necessary to secure that these are objective, transparent and non-discriminatory, especially in lights of the costs and benefits of various electricity generation and distributed generation, and monitors their observance by system operators;
- drafts and approves the Regulation on the Quality of Electricity Transmission and Distribution Services, and monitors the observance of the quality parameters by system operators;
- drafts and approves, under the provisions of this law, methodologies, regulations, other regulatory secondary legislation which establish rights and obligations of the producers, electricity transmission system operator, electricity distribution system operator, electricity market operator, suppliers and the consumers;
- initiates and performs public consultations and cooperates for the purposes of collection of information and proposals necessary to assess the solutions and approve justified decisions and resolutions, as well as for the purposes of harmonization of regulatory practices in compliance with the national harmonization plans;

The **Distribution System Operator** owns electricity distribution networks, is entitled to distribute electricity, is in charge for exploitation, maintenance, including re-technology, and development of electricity distribution networks, and for assuring that electricity distribution networks are able to satisfy, continuously and on a reasonable level, the demand for the electricity distribution services;

Distribution system operator has the following competencies [16]:

- to ensure long-term capacities of electricity distribution networks by drafting and implementation of electricity distribution networks' development plans, taking into account, in special, planned capacities of electricity demand;
- to take other measures necessary to render electricity distribution services and public service obligations, under regulated, equal and non-discriminatory to all system users conditions, in compliance with licensing conditions, provisions of [16], the Regulation on Connection, Technical rules of electricity networks, the Regulation on the Quality of Electricity Transmission and Distribution Services, the Rules of Electricity Market and other secondary regulatory legislation approved by the Agency, in full compliance with the principles of accessibility, availability, continuity, efficiency, quality and transparency.

Distribution system operator is obliged to comply with quality parameters provided by the Regulation on Quality of Transmission and Distribution of Electricity.

The **Transmission System Operator** owns electricity transmission networks, is entitled to transport electricity and manage electric energy system from an operational and technical perspective, is in charge for exploitation, maintenance, including re-technology, and development of electricity transport networks and interconnections, and for assuring that electricity transmission networks are able to satisfy, continuously and on a reasonable level, the demand for the electricity transmission services [16]. The transmission network is made up of 400-kilovolt (kV), 330-kV and 110-kV lines.

The transmission system operator is obliged to organize, as provided by license for centralized management of electric energy system, single operational and technical management of electric energy system and electricity flow deriving from or managed by electric energy systems of other states, as provided by the agreements concluded with the participants of electricity market, and requests filed by the parties to these agreements. The rules of single operational and technical management are provided by this law, the Technical rules of electricity networks, the Rules of electricity market and other secondary regulatory legislation approved by the Agency.

Transmission system operator is obliged to comply with quality parameters provided by the Regulation on Quality of Transmission and Distribution of Electricity.

Moldova's electricity **generation capacity** on the west side of the Dniester River (i.e. excluding the Transnistria region) is approximately 350 megawatts (MW), 300 MW of which is produced by Termoelectrica SA (combined heat and power-1 [CHP-1] and CHP-2 plants). New planned capacity includes a 250-MW combined cycle gas turbine (CCGT) plant in Chisinau and 150 MW of renewables-based generation.

3.2. Grid Codes - Current state of affairs

According to the [16] for the purposes of safe, inoffensive and stable functioning of electricity transmission and distribution networks, establishment of conditions necessary to render electricity transmission and distribution services to system users, on continuous, viable and efficient grounds, system operators shall plan, develop, modernize, maintain and exploit electricity networks in compliance with the minimum technical and organizational requirements provided by Electrical Grid Code.

Transmission system operator is obliged to draft, in cooperation with other system operators, Electrical Grid Code and file it with the Agency for examination and approval. The draft shall contain provisions on Electrical Grid Code, previously drafted and submitted by distribution system operators. The Agency publishes the draft of Electrical Grid Code on its webpage, organizes public hearings with system users, other participants of the electricity market and other state authorities, as provided by secondary regulatory legislation. Proposal filed by them, together with a decision on their acceptance or refusal shall be specified in a summary of recommendations to be published on the webpage of the Agency. Electrical Grid Code, approved by the Agency, shall be published in the Official Gazette of the Republic of Moldova, webpage of the Agency and webpages of other system operators.

According to [16] in the context of obligations undertaken by the Republic of Moldova by the Energy Community Treaty, transmission system operators shall draft Electrical Grid Code. System operators shall cooperate with this system operator for the purposes of drafting.

Electrical Grid Code version from 2019 is applicable at the moment [37]. The network connection codes are not transposed by formal governmental or regulatory act as required by the PHLG's decisions, but have been included into the Grid Code approved by the regulator.

Agency is responsible for the **derogation**, for deviations from the connection requirements for both the transmission and the distribution system.

3.3. Gap analysis

Document Electrical Grid Code version from 2019 [37] is used for gap analysis:

Electrical Grid Code consider Distribution and Transmission grid codes.

3.3.1. RfG Non-Exhaustive Requirements

Network Codes are transposed through the Electrical Grid Code. This is not a good practice. Network Codes should be transposed as regulations, and non-exhaustive requirements should be specified in Electrical Grid Code. In addition, non-exhaustive requirements are not defined.

3.3.1.1. Determination of significance

Non-exhaustive requirements are not defined.

3.3.1.2. Frequency Issues

Non-exhaustive requirements are not defined.

3.3.1.3. Voltage Issues

Non-exhaustive requirements are not defined.

Regarding voltage range requirements at the connection point for PGMs, corresponding parameters are indicated in the following tables.

Table 1 - Voltage range requirements

Voltage range	Operating period
0.85 pu-0.90 pu	30 minutes
0.90 pu-1.118 pu	Unlimited
1,118 pu-1.15 pu	20 minutes

The table shows the minimum lengths of time that a generating unit must be able to operate without disconnecting at mains voltages that deviate from the reference value 1 per unit at the connection point, if the voltage considered for the unit values pu is between 110 kV and 300 kV.

Table 2 - Voltage range requirements

Voltage range	Operating period
0.88 pu-0.90 pu	20 minutes
0.90 pu-1.097 pu	Unlimited
1,097 pu-1.15 pu	20 minutes

The table shows the minimum lengths of time that a generating unit must be able to operate without disconnecting at mains voltages that deviate from the 1 pu reference value at the connection point, if the voltage considered for the unit values pu is between 300 kV and 400 kV.

Table 1 and Table 2 are not in line with REGULATION (EU) 2016/631 of 14 April 2016 ESTABLISHING A NETWORK CODE ON REQUIREMENTS FOR GRID CONNECTION OF GENERATORS, incorporated and adapted by Permanent High Level Group Decision 2018/03/PHLG-EnC. These ranges are specified for Baltic countries and Table 2 is for voltage range between 300 kV and 500 kV.

Regarding voltage range requirements at the connection point for DSOs and demand facilities, corresponding parameters are indicated in the following tables.

Table 3 - Voltage range requirements

Voltage range	Operating period
0.90 pu-1.097 pu	Unlimited
1,097 pu-1.15 pu	20 minutes

The table shows the minimum periods for which a consumption site connected to the transmission network, a distribution site connected to the transmission network or a distribution system connected to the transmission network must be able to operate without disconnection to mains voltages, deviating from the reference value 1 pu at the connection point, if the voltage considered for the unit values pu is between 300 kV and 400 kV (inclusive).

Table 4 - Voltage range requirements

Voltage range	Operating period
0.90 pu-1.05 pu	Unlimited
1.05 pu-1.1 pu	20 minutes

The table shows the minimum periods for which a consumption site connected to the transmission network, a distribution site connected to the transmission network or a distribution system connected to the transmission network must be able to operate without disconnection to mains voltages, deviating from the reference value 1 pu at the connection point, if the voltage considered for unit values pu is greater than 400 kV.

These requirements are not in line with COMMISSION REGULATION (EU) 2016/1388 of 17 August 2016 ESTABLISHING A NETWORK CODE ON DEMAND CONNECTION, incorporated and adapted by Permanent High Level Group Decision 2018/05/PHLG-EnC of 12 January 2018. Table 3 and Table 4 should be merged in one table for voltage range between 300 kV and 500 kV, with parameters from Table 3.

3.3.1.4. System Restoration Issues

Non-exhaustive requirements are not defined.

3.3.1.5. Instrumentation, Simulation Models and Protections Issues

Non-exhaustive requirements are not defined.

3.3.2. DCC Non-Exhaustive Requirements

3.3.2.1. Frequency Issues

Non-exhaustive requirements are not defined.

3.3.2.2. Voltage Issues

Non-exhaustive requirements are not defined.

3.3.2.3. System Restoration Issues

Non-exhaustive requirements are not defined.

3.3.2.4. Instrumentation, Simulation Models and Protections Issues

Non-exhaustive requirements are not defined.

4. References

- [1] European Council. (2018). Commission Regulation (EU) 2016/631 of 14 April 2016 establishing a network code on requirements for grid connection of generators
- [2] European Council. (2018). Commission Regulation (EU) 2016/1388 of 17 August 2016 establishing a Network Code on Demand Connection
- [3] European Council. (2018). Commission Regulation (EU) 2016/1447 of 26 August 2016 establishing a network code on requirements for grid connection of high voltage direct current systems and direct current-connected power park modules
- [4] The Permanent High Level Group of Energy Community. (2018). DECISION No 2018/03/PHLG-EnC OF THE PERMANENT HIGH LEVEL GROUP OF THE ENERGY COMMUNITY of 12 January 2018 on incorporating Commission Regulation (EU) 2016/631 of 14 April 2016 establishing a Network Code on requirements for grid connection of generators in the Energy Community
- [5] The Permanent High Level Group of Energy Community. (2018). DECISION 2018/05/PHLG-EnC OF THE PERMANENT HIGH LEVEL GROUP OF THE ENERGY COMMUNITY of 12 January 2018 on incorporating Commission Regulation (EU) 2016/1388 of 17 August 2016 establishing a Network Code on Demand Connection in the Energy Community
- [6] The Permanent High Level Group of Energy Community. (2018). DECISION No 2018/04/PHLG-EnC OF THE PERMANENT HIGH LEVEL GROUP OF THE ENERGY COMMUNITY of 12 January 2018 on incorporating Commission Regulation (EU) 2016/1447 of 26 August 2016 establishing a network code on requirements for grid connection of high voltage direct current systems and direct current connected power park modules in the Energy Community
- [7] ENTSO-E. (2020). Parameters of Non-exhaustive Requirements, ENTSO-E, Guidance document for national implementation for network codes on grid connection
- [8] ENTSO-E. (2016). Parameters related to voltage issues, ENTSO-E guidance document for national implementation for network codes on grid connection
- [9] ENTSO-E. (2016). Reactive power control modes for PPM & HVDC, ENTSO-E guidance document for national implementation for network codes on grid connection
- [10] ENTSO-E. (2016). Reactive power requirement for PPMS & HVDC at low / zero power, ENTSO-E guidance document for national implementation for network codes on grid connection
- [11] ENTSO-E. (2016). Fault current contribution from PPMS & HVDC, ENTSO-E guidance document for national implementation for network codes on grid connection
- [12] ENTSO-E. (2016). Instrumentation, simulation models and protection, ENTSO-E guidance document for national implementation for network codes on grid connection
- [13] ENTSO-E. (2016). SELECTING NATIONAL MW BOUNDARIES, ENTSO-E guidance document for national implementation for network codes on grid connection
- [14] ENTSO-E. (2016). Demand Response - System Frequency Control, ENTSO-E guidance document for national implementation for network codes on grid connection
- [15] ENTSO-E. (2016). Reactive power management at T - D interface, ENTSO-E guidance document for national implementation for network codes on grid connection
- [16] LEGE Nr. 107 din 27-05-2016 cu privire la energia electrică
https://www.legis.md/cautare/getResults?doc_id=105978&lang=ro
- [17] DECISION No. 127 from 14-05-2020 for the approval of the Criteria for granting derogations from the requirements of the Electrical Networks Code, approved by the Decision of the Board of Directors of the National Agency for Energy Regulation no. 423/2019 of November

- 22, 2019
https://www.legis.md/cautare/getResults?doc_id=121542&lang=ro
- [18] DECISION No. 538 of 27-12-2019 for the amendment of the Regulation on the quality of electricity transmission and distribution services, approved by the Decision of the Board of Directors of the National Agency for
https://www.legis.md/cautare/getResults?doc_id=120135&lang=ro
- [19] DECISION No. 393 from 01-11-2019 on the approval of the normative-technical document in the field of energy NE1-01: 2019 "Norms for the operation of electrical installations of non-household consumers"
https://www.legis.md/cautare/getResults?doc_id=120132&lang=ro
- [20] DECISION No. 168 from 31-05-2019 on the approval of the Regulation on the connection to electricity networks and the provision of electricity transmission and distribution services
https://www.legis.md/cautare/getResults?doc_id=114958&lang=ro
- [21] DECISION No. 94 from 04-04-2019 on the approval of the Regulation on the development of electricity distribution networks
https://www.legis.md/cautare/getResults?doc_id=124161&lang=ro
- [22] DECISION No. 49 from 11-03-2019 for the amendment of the Regulation on the quality of electricity transmission and distribution services, approved by the Decision of the Board of Directors of ANRE no. 282/2016 of 11.11.2016
https://www.legis.md/cautare/getResults?doc_id=113466&lang=ro
- [23] DECISION No. 415 of 10-11-2020 regarding the tariffs for the auxiliary services provided by Î.C.S „Premier Energy Distribution" SA
https://www.legis.md/cautare/getResults?doc_id=124032&lang=ro
- [24] DECISION No. 269 of 28-09-2018 on the approval of the Methodology for the calculation, approval and application of regulated tariffs for ancillary services provided by system operators in the electricity sector
https://www.legis.md/cautare/getResults?doc_id=110796&lang=ro
- [25] NATIONAL AGENCY FOR ENERGY REGULATION DECISION No. 484 of 13-12-2017 on the approval of the Regulation on quality indicators for heat distribution and supply services
https://www.legis.md/cautare/getResults?doc_id=103986&lang=ro
- [26] DECISION No. 299 of 26-06-2017 on the presentation to ENTSO-E of information on the electricity market of the Republic of Moldova and their publication
https://www.legis.md/cautare/getResults?doc_id=101657&lang=ro
- [27] DECISION No. 282 of 11-11-2016 for the approval of the Regulation on the quality of electricity transmission and distribution services
https://www.legis.md/cautare/getResults?doc_id=120278&lang=ro
- [28] DECISION No. 382 from 02-07-2010 on the approval of the Regulation on the measurement of electricity for commercial purposes
https://www.legis.md/cautare/getResults?doc_id=10363&lang=ro
- [29] DECISION No. 283 of 15-11-2016 on the approval of the Regulation on the planning, approval and execution of investments
https://www.legis.md/cautare/getResults?doc_id=97424&lang=ro
- [30] DECISION No. 482 of 13.12.2017 on the approval of the Regulation on the monitoring of compliance programs
<http://lex.justice.md/index.php?action=view&view=doc&lang=1&id=373776>
- [31] DECISION No. 269 of 28-09-2018 on the approval of the Methodology for the calculation, approval and application of regulated tariffs for ancillary services provided by system operators in the electricity sector
https://www.legis.md/cautare/getResults?doc_id=110796&lang=ro
- [32] DECISION No. 316 of 09.11.2018 on the approval of the Regulation on the dispatching management of the electric power system
<http://lex.justice.md/index.php?action=view&view=doc&lang=1&id=379030>
- [33] DECISION No. 89 din 13.03.2003 on the approval of the "Instruction on the calculation of technological consumption of electricity in distribution networks depending on the value of

- the power factor in consumer utilization facilities"
<http://lex.justice.md/index.php?action=view&view=doc&lang=1&id=291369>
- [34] DECISION No. 246 from 02.05.2007 on the approval of the Instruction on the calculation of active and reactive electricity losses in the network elements in the consumer balance
<http://lex.justice.md/index.php?action=view&view=doc&lang=1&id=324192>
- [35] DECISION No. 267 din 20.11.2007 on the approval of the Technical Norms of the electrical distribution networks
<http://lex.justice.md/index.php?action=view&view=doc&lang=1&id=326107>
- [36] DECISION No. 906 of 24-09-2018 regarding the reorganization of some legal entities
https://www.legis.md/cautare/getResults?doc_id=109080&lang=ro
- [37] DECISION No. 423 of 22-11-2019 on the approval of the Electrical Networks Code
https://www.legis.md/cautare/getResults?doc_id=120014&lang=ro
- [38] DECISION No. 212 of 09.10.2015 regarding the approval of the Rules electricity market
<http://lex.justice.md/md/362186/>
- [39] DECISION No. 283 from 07-08-2020 on the approval of the Electricity Market Rules
https://www.legis.md/cautare/getResults?doc_id=123381&lang=ro
- [40] DECISION No. 102 from 05-02-2013 on the Energy Strategy of the Republic of Moldova until 2030
https://www.legis.md/cautare/getResults?doc_id=68103&lang=ro
- [41] RAPORT ANUAL privind activitatea Autorității Naționale de Reglementare în Domeniul Energiei 2017
- [42] Norms for the operation of electrical grids (Proiectul Normelor de exploatare tehnică a rețelelor electrice)
<http://anre.md/storage/upload/projects/announcements//tmp/phpkVIPfF/Proiect%20Norme%20de%20exploatare%20tehnice%C4%83%20a%20re%C8%9Belelor%20electrice.pdf>
- [43] TYDP 2018 - 2027
https://moldelectrica.md/files/docs/TYNDP_EN.pdf
- [44] RES requirements used prior to approval of ENTSO-E grid code
<https://moldelectrica.md/files/docs/cerinte-tehnice-fata-de-centralele-electrice-regenerabile.pdf>
- [45] Opinion 6/19 pursuant to Article 3(1) of Regulation (EC) No 714/2009 and Article 10(6) of Directive 2009/72/EC - Republic of Moldova - Certification of Moldelectrica

Appendix 1

		Thresholds Moldova		
Limits for thresholds for type B, C and D power-generating modules	MW	Definition of Parameters/ Ranges/Values at national level	Defined in document/Article No.	Comments
B	0,5			
C	10			
D	15			

Technical Assistance for the Connection Network Codes implementation in the Energy Community

FCN	Non-exhaustive Requirement	Non mandatory Requirement	RfG NC Article No.	Applicability	Parameters/ Ranges/Values	Timing of Proposal		Proposer	RfG Instrumentation - Moldova		
						Requirement as such	Values/Range of Requirement		Definition of Parameters/ Ranges/Values at national level	Defined in document/Article No.	Comments
1	Control Scheme and Settings	-	<u>14(5)(a)</u>	B,C,D	Control schemes of the control devices Control settings of the control devices	S	S (control schemes in due time for plant design and setting values before plant commissioning and to be reselected as appropriate)	Agreement and coordination between the TSO, the RSO (TSO and DSO) and the PGFO			
2	Electrical Protection Schemes and Settings	-	<u>14(5)(b)</u>	B,C,D	Electrical protection schemes Electrical protection settings	S	S (protection schemes in due time for plant design and setting values before plant commissioning and to be reselected as appropriate)	Agreement and coordination between the RSO and the PGFO			
3	Information Exchanges	-	<u>14(5)(d)</u>	B,C,D	Content of information exchange Precise list of data to be facilitated Precise time of data to be facilitated	G (principle)	S (value)	RSO (DSO or TSO) or TSO			

Technical Assistance for the Connection Network Codes implementation in the Energy Community

4	Manual, local Measures where the Automatic Remote Devices are out of Order	-	<u>15(2)(b)</u>	C,D	Time period to reach the requested set point in cases where the automatic remote control devices are out of service Tolerance to reach the requested set point in cases where the automatic remote control devices are out of service	S	S (value)	RSO (DSO or TSO) or TSO			
5	Loss of Angular Stability or Loss of Control	-	<u>15(6)(a)</u>	C,D	Criteria to detect loss of angular stability or loss of control	S	S (value)	Agreement between the PGFO and the RSO (DSO or TSO), in coordination with the TSO			
6	Instrumentation	X	<u>15(6)(b)(i)</u>	C,D	Definition of the quality of supply parameters	S	G/S	RSO			
7	Instrumentation	-	<u>15(6)(b)(ii)</u>	C,D	Settings of the fault recording equipment Triggering criteria of the fault recording equipment Sampling rates of the fault recording equipment	S	S (value)	Agreement between the PGFO and the RSO (DSO or TSO), in coordination with the TSO			
8	Instrumentation	-	<u>15(6)(b)(iii)</u>	C,D	Specifications of the oscillation trigger detecting poorly damped power oscillations	S	S (value)	RSO in coordination with the TSO			

Technical Assistance for the Connection Network Codes implementation in the Energy Community

9	Instrumentation	-	<u>15(6)(b)(iv)</u>	C,D	Protocols for recorded data	S	S	Agreement between the PGFO, the RSO and the relevant TSO			
10	Simulation Models	X	<u>15(6)(c)(i)</u>	C,D	Provision of simulation models	G	S	RSO in coordination with the TSO			
11	Simulation Models	X	<u>15(6)(c)(iii)</u>	C,D	Specifications of the simulation models	G	G	RSO in coordination with the TSO			
12	Simulation Models	X	<u>15(6)(c)(iv)</u>	C,D	Recordings of PGM performance	S	G/S	RSO in coordination with the TSO			
13	Installation of Devices for System Operations and Security	X	<u>15(6)(d)</u>	C,D	Definitions of the devices needed for system operation and system security	S	S	RSO or TSO and PGFO			
14	Neutral Point at the Network Side of Step- Up Transformers	-	<u>15(6)(f)</u>	C,D	Specifications of the earthing arrangement of the neutral point at the network side of the step-up transformers	G (principle)	S (value in due time for plant design and to be reselected as appropriate)	RSO			
15	Automatic Disconnection	X	<u>16(2)(c)</u>	D	Definition of the threshold for automatic disconnection Definition of the parameters	S	S (value)	RSO in coordination with the TSO Agreement between the RSO and the PGFO			
16	Synchronization	-	<u>16(4)(d)</u>	D	Settings of the synchronization devices	G	G (range) S (value before plant commissioning and to be reselected as appropriate)	Agreement between the RSO and the PGFO			
17	Angular Stability	-	<u>19(3)</u>	SPGM D	Agreement for technical capabilities of the PGM to aid angular stability	S	S	Agreement between the TSO and the PGFO			
18	Synthetic Inertia	X	<u>21(2)</u>	PPM C,D	Definition of the operating principle of control systems to provide synthetic inertia Related performance parameters to provide synthetic inertia	G	S	TSO			

Technical Assistance for the Connection Network Codes implementation in the Energy Community

FCN	Non-exhaustive Requirement	Non mandatory Requirement	DCC NC Article No.	Applicability	Parameters/ Ranges/Values	Timing of Proposal		Proposer	DCC_Instrumentation - Moldova		
						Requirement as such	Values/Range of Requirement		Definition of Parameters/ Ranges/Values at national level	Defined in document/Article No.	Comments
1	Electrical Protection Scheme and settings	-	<u>16(1)</u>	TC DF and TC DS	Electrical protection schemes Electrical protection settings	S	S (protection schemes in due time for plant design and setting values before plant commissioning and to be reselected as appropriate)	agreement between relevant TSO and TC DSO or TC DF owner			
2	Control Requirements	-	<u>17(1)</u>	TC DF and TC DS	Control devices schemes Control devices settings	S	S (control schemes in due time for plant design and setting values before plant commissioning and to be reselected as appropriate)	agreement between TSO and TC DSO or TC DF owner			
3	Information Exchanges	-	<u>18(1)</u>	TC DF	Standards to exchange information and time stamping	G	G (value)	Relevant TSO			
4	Information Exchanges	-	<u>18(2)</u>	TC DS	Standards to exchange information and time stamping	G	G (value)	Relevant TSO			
5	Information Exchanges	-	<u>18(3)</u>	TC DF and TC DS	Make information exchange standards publically available	G	G (value)	Relevant TSO			
6	Simulation Models	X	<u>21(2)</u>	TC DF and TC DS	Requirements for the simulation models or equivalent information	G	G	Relevant TSO			

Technical Assistance for the Connection Network Codes implementation in the Energy Community

6	Simulation Models	-	<u>21(3)</u>	TC-DF, TC-DS	Content and format of the simulation models or equivalent information	G	G (value)	TSO			
8	Simulation Models	-	<u>21(4)</u>	TC DF and TC DS	Sub-models or equivalent information included in Art. 21.3.	G	G	TSO			
9	Simulation Models	-	<u>21(5)</u>	TC DF and TC DS	Requirements for the recordings to be compared with the response of the model	G	S (value)	RSO or relevant TSO			

Technical Assistance for the Connection Network Codes implementation in the Energy Community

FCN	Non-exhaustive Requirement	Non mandatory Requirement	RfG NC Article No.	Applicability	Parameters/ Ranges/Values	Timing of Proposal		Proposer	RfG_System_Restoration_Issues - Moldova		
						Requirement as such	Values/Range of Requirement		Definition of Parameters/ Ranges/Values at national level	Defined in document/Article No.	Comments
1	Reconnection Capability	-	14(4)(a)	B,C,D	Conditions for reconnection to the network after an incidental disconnection caused by network disturbance	G	G	TSO			
2	Reconnection Capability	-	14(4)(b)	B,C,D	Conditions for automatic reconnection	G	G	TSO			
3	Blackstart Capability	X	15(5)(a)(iii)	C,D	Technical specifications for a quotation for black start capability	G (principle)	S	TSO			
4	Blackstart Capability	X	15(5)(a)(iii)	C,D	Timeframe within which the PGM is capable of starting from shutdown without any external electrical energy supply	G	G (value)	RSO (DSO or TSO) in coordination with the TSO			
5	Blackstart Capability	X	15(5)(a)(iv)	C,D	Voltage limits for synchronization when article 16.2 does not apply	G	G (range)	RSO (DSO or TSO)			
6	Capability of Island Operation	X	15(5)(b)	C,D	Capability of island operation	S	S	RSO (DSO or TSO) in coordination with the TSO			
7	Capability of Island Operation	X	15(5)(b)(i)	C,D	Definition of quality of supply parameters	S	S	RSO (DSO or TSO) in coordination with the TSO			
8	Capability of Island Operation	X	15(5)(b)(iii)	C,D	Methods and criteria for detecting island operation	S	S	Agreement between the PGFO and the RSO (DSO or TSO) in coordination with the TSO			

Technical Assistance for the Connection Network Codes implementation in the Energy Community

9	Operation following Tripping to Houseload	X	15(5)(c)(i)	C,D	Provision of quick re-synchronization capability	G	S	Agreement between the PGFO and the RSO (DSO or TSO) in coordination with the TSO			
10	Operation following Tripping to Houseload	-	15(5)(c)(iii)	C,D	Minimum operation time within which the PGM is capable of operating after tripping	G	G (value)	RSO (DSO or TSO) in coordination with the TSO			
11	Active Power Recovery SPGM	-	17(3)	B,C,D	Definition of the magnitude and time for active power recovery	G	G (value)	TSO			
12	Post Fault Active Power Recovery PPM	-	20(3)(a)	B,C,D	Specification when the post-fault active power recovery begins Specification of the max. allowed time for active power recovery Specification of magnitude and accuracy for active power recovery	G	G (value)	TSO			

Technical Assistance for the Connection Network Codes implementation in the Energy Community

FCN	Non-exhaustive Requirement	Non mandatory Requirement	DCC NC Article No.	Applicability	Parameters/ Ranges/Values	Timing of Proposal		Proposer	DCC_System_Restoration_Issues - Moldova		
						Requirement as such	Values/Range of Requirement		Definition of Parameters/ Ranges/Values at national level	Defined in document/Article No.	Comments
1	Short circuit requirements	-	<u>14(1)</u>	TC DF and TC DS	Maximum short- circuit current at the connection point to be withstood	G	G (value)	relevant TSO			
2	Short circuit requirements		<u>14(2)</u>	TC DF and TC DS	An estimate of the minimum and maximum short- circuit currents to be expected at the connection point as an equivalent of the network	G	G	relevant TSO			
3	Short circuit requirements	-	<u>14(3)</u>	TC DF and TC DS	Unplanned events: threshold of the maximum short circuit current inducing an information from the TSO in case of a change above this threshold	G	S (value)	relevant TSO			
4	Short circuit requirement	X	<u>14(5)</u>	TC DF and TC DS	Planned events: threshold of the maximum short circuit current inducing an information from the TSO in case of a change above this threshold	G	S (value)	relevant TSO			
5	Short circuit requirement	-	<u>14(8)</u>	TC DF and TC DS	Unplanned events: threshold of the maximum short circuit current inducing an information from the TC DF or TC DSO in case of a change above this threshold	G	S (value)	TC DF owner or TC DSO			
6	Short circuit requirements	-	<u>14(9)</u>	TC DF and TC DS	Planned events: threshold of the maximum short circuit current inducing an information from the TC DF or TC DSO in case of a change above this threshold	G	S (value)	relevant TSO			

Technical Assistance for the Connection Network Codes implementation in the Energy Community

7	Demand disconnection for system defense	-	<u>19(1)(a)</u>	TC DF and TC DS	Definition the capabilities of Low Frequency Demand Disconnection (LFDD) scheme	G (principle)	S	relevant TSO			
8	Demand disconnection for system defense	-	<u>19(1)(c)</u>	TC DF and TC DS	Frequency range: at least between 47-50 Hz,adjustable in steps of 0,05 Hz; Operating time: no more than 150 ms after triggering the frequency setpoint; Voltage lock-out: blocking of the functional capability shall be possible when the voltage is within a range of 30 to 90 % of reference 1 pu voltage; Provide the direction of active power flow at the point of disconnection;	G	G	RSO			
9	Demand disconnection for system defense	x	<u>19(2)(a)</u>	TC DS	Definition of the LVDD scheme	G (principle)	S (value)	relevant TSO, in coordination with the TC DSO			
10	Demand disconnection for system defense	x	<u>19(2)(b)</u>	TC DF	Definition of the LVDD scheme	G (principle)	S (value)	relevant TSO, in coordination with the TC DF owner			
11	Demand disconnection for system defense	x	<u>19(2)(c)</u>	TC DS	Implementation of on load tap changer blocking and low voltage demand disconnection	S	S	relevant TSO			
12	Demand disconnection for system defense	x	<u>19(2)(d)</u>	TC DF and TC DS	Equipment for both on load tap changer blocking and low voltage demand disconnection coordination	S	S	relevant TSO			

Technical Assistance for the Connection Network Codes implementation in the Energy Community

13	Demand disconnection for system defense	X	19(3)(a)	TC DF and TC DS	Requirement of automatic or manual on load tap changer blocking;	S	S	TSO			
14	Demand disconnection for system defense	-	19(3)(b)	TC DS	Definition of the automatic on load tap changer blocking scheme	G (principle)	S (value)	TSO			
15	Demand disconnection for system defense	-	19(4)(a)	TC DF and TC DS	Definition of the conditions for reconnection after a disconnection	G	G	relevant TSO			
16	Demand disconnection for system defense	-	19(4)(b)	TC DF and TC DS	Settings of the synchronization devices (including frequency, voltage, phase angle range and deviation of voltage and frequency)	S	S (value in due time for plant design and to be reselected as appropriate)	agreement between relevant TSO and TC DSO or TC DF owner			
17	Demand disconnection for system defense	X	19(4)(c)	TC DF and TC DS	Definition of the automated disconnection equipment Time for remote disconnection	G	S (value)	relevant TSO			

Technical Assistance for the Connection Network Codes implementation in the Energy Community

FCN	Non-exhaustive Requirement	Non mandatory Requirement	RfG NC Article No.	Applicability	Parameters/ Ranges/Values	Timing of Proposal		Proposer	RfG_Frequency_Issues - Moldova		
						Requirement as such	Values/Range of Requirement		Definition of Parameters/ Ranges/Values at national level	Defined in document/Article No.	Comments
1	Frequency Ranges	-	<u>13(1)(a)(i)</u>	A,B,C,D	Time period for: 47.5Hz-48.5Hz (SAs: CE, Baltic) 48.5Hz-49.0Hz (SAs: CE, Nordic, GB, IR, Baltic) 51.0Hz-51.5Hz (SAs: Baltic)	G	G (value)	TSO			
2	Frequency Ranges	X	<u>13(1)(a)(ii)</u>	A,B,C,D	Potential wider frequency ranges Potential longer minimum times Specific requirements for frequency and voltage deviations	S	S (value)	Agreement between the RSO (DSO or TSO), in coordination with the TSO, and the PGFO			
3	RoCoF	-	<u>13(1)(b)</u>	A,B,C,D	Max. RoCoF and measuring window for which PGM shall stay connected	G	G (value)	TSO			
4	RoCoF	-	<u>13(1)(b)</u>	A,B,C,D	Specify RoCoF of the loss of main protection	S	S	RSO in coordination with the TSO			
5	LFSM-O	-	<u>13(2)(a)</u>	A,B,C,D	Frequency threshold Droop settings	G	G (range) S (value before plant commissioning and to be reselected as appropriate using capabilities defined at CNC national implementation)	TSO			
6	LFSM-O	X	<u>13(2)(b)</u>	A	Use of automatic disconnection and reconnection	G	G (value and criteria)	TSO			
7	LFSM-O	X	<u>13(2)(f)</u>	A,B,C,D	Expected behaviour of the PGM once the regulating minimum level is reached	S	-	TSO			
8	Admissible Active Power Reduction	-	<u>13(4)</u>	A,B,C,D	Admissible active power reduction from max. output with falling frequency	G	S (reviewed in due time for plant design)	TSO			
9	Admissible Active Power Reduction from maximum Output with falling Frequency	-	<u>13(5)</u>	A,B,C,D	Definition of the ambient conditions applicable when defining the admissible active power reduction and take into account of the capabilities of PGM	G	S (reviewed in due time for plant design)	TSO			
10	Logic Interface (1)	X	<u>13(6)</u>	A, B	Requirements for the additional equipment necessary to allow active power output to be remotely operable	S	-	RSO			
11	Automatic Connection to the Network	-	<u>13(7)</u>	A,B,C	Conditions for automatic connection to the network regarding: Frequency ranges Corresponding delay time Maximum admissible gradient of increase in active power output	G	G	TSO			

Technical Assistance for the Connection Network Codes implementation in the Energy Community

12	Logic Interface (2)	X	<u>14(2)(b)</u>	B	Requirements for the equipment necessary to make the logic interface remotely operable (to cease active power output)	S	-	RSO			
13	Frequency Stability	-	<u>15(2)(a)</u>	C,D	Time period to reach the adjusted active power set point Tolerance applying to the new set point Time period to reach tolerance applying to the new set point	G	G	TSO			
14	LFSM-U	-	<u>15(2)(c)</u>	C,D	Frequency threshold Droop Definition of Pref	G	G (range) S (adjustable setting in due time for plant design and to be reselected as appropriate using capabilities defined at CNC national implementation)	TSO			
15	Frequency Sensitive Mode	-	<u>15(2)(d)(i)</u>	C,D	Active power range related to maximum capacity Frequency response insensitivity Frequency response dead band Droop	G	G (range) S (adjustable setting and to be reselected as appropriate using capabilities defined at CNC national implementation)	TSO			
16	Frequency Sensitive Mode (FSM)	-	<u>15(2)(d)(iii)</u>	C,D	Maximum admissible full activation time	G	G	TSO			
17	Frequency Sensitive Mode (FSM)	X	<u>15(2)(d)(iv)</u>	C,D	Maximum admissible initial delay for PGMs without inertia	G	S	TSO			
18	Frequency Sensitive Mode (FSM)	-	<u>15(2)(d)(v)</u>	C,D	Time period for the provision of full active power frequency response	G	G	TSO			
19	Frequency Restoration Control	-	<u>15(2)(e)</u>	C,D	Specifications of the frequency restoration control	G	G	TSO			
20	Real-Time Monitoring of FSM	-	<u>15(2)(g)</u>	C,D	List of the necessary data which will be sent in real time Definition of additional signals	S	S	RSO (DSO or TSO) or TSO			

Technical Assistance for the Connection Network Codes implementation in the Energy Community

21	Rates of Change of Active Power Output	-	<u>15(6)(e)</u>	C,D	Taking into consideration the specific characteristics of the prime mover technology: Minimum limit of change of active power output in down direction Maximum limit of change of active power output in down direction Minimum limit of change of active power output in up direction Maximum limit of change of active power output in up direction	G	S (reviewed in due time for plant design)	RSO in coordination with the TSO			
22	Rates of Change of Active Power Output	-	<u>15(6)(d)</u>	C,D	Additional devices for secure system operation	S	S	RSO in coordination with the TSO			

Technical Assistance for the Connection Network Codes implementation in the Energy Community

FCN	Non-exhaustive Requirement	Non mandatory Requirement	DCC NC Article No.	Applicability	Parameters/ Ranges/Values	Timing of Proposal		Proposer	DCC_Frequency_Issues - Moldova		
						Requirement as such	Values/Range of Requirement		Definition of Parameters/ Ranges/Values at national level	Defined in document/Article No.	Comments
1	Frequency Ranges	-	<u>12(1) and Annex I</u>	TC DF and TC DS	Time period for: 47.5Hz-48.5Hz (SAs: CE, Baltic) 48.5Hz-49.0Hz (SAs: CE, Nordic,GB, IR, Baltic) 51.0Hz-51.5Hz (SAs: Baltic)	G	G (value)	Relevant TSO			
2	Frequency Ranges	X	<u>12(2) and Annex I</u>	TC DF and TC DS	Potential wider frequency ranges Potential longer minimum times Specific requirements for frequency and voltage deviations	S	S (value)	agreement between DSO, TC DF owner and TSO			
3	DRS	X	<u>28(2)(k)</u>	DF and CDS offering DRS	Rate of change of frequency withstand over a 500ms time period	G	G	relevant TSO			
4	DRS	X	<u>29(2)(c)</u>	DF and CDS offering DRS	for DU connected below 110 kV: Definition of the normal operating range	G	G (value)	relevant SO			
5	DRS	X	<u>29(2)(d)</u>	DF and CDS offering DRS	Definition of the allowed frequency deadband	G	G (value)	relevant TSO, in consultation with TSOs of the synchronous area			
6	DRS	X	<u>29(2)(e)</u>	DF and CDS offering DRS	Definition of the frequency ranges for DRS System Frequency Control (SFC) Definition of the maximum frequency deviation to respond	G	G (value)	relevant TSO, in consultation with TSOs of the synchronous area			
8	DRS	X	<u>29(2)(g)</u>	DF and CDS offering DRS	Definition of the rapid detection of frequency system changes Definition of the response to frequency system changes	G	G	relevant TSO, in consultation with TSOs of the synchronous area			

Technical Assistance for the Connection Network Codes implementation in the Energy Community

FCN	Non-exhaustive Requirement	Non mandatory Requirement	RfG NC Article No.	Applicability	Parameters/ Ranges/Values	Timing of Proposal		Proposer	RfG_Voltage_Issues - Moldova		
						Requirement as such	Values/Range of Requirement		Definition of Parameters/ Ranges/Values at national level	Defined in document/Article No.	Comments
1	Fault Ride Through Capability	-	<u>14(3)(a)(i)</u> (Voltage-against- time profile)	B,C,D	SPGM: Uret, Uclear,Urec1,Urec2 tclear, trec1, trec2, trec3	G	G	TSO			
2	Fault Ride Through Capability	-	<u>14(3)(a)(i)</u> (Voltage-against- time profile)	B,C,D	PPM: Uret, Uclear, Urec1, Urec2 tclear, trec1, trec2, trec3	G	G	TSO			
3	Fault Ride Through Capability	-	<u>14(3)(a)(iv)</u>	B,C,D	Pre-fault minimum short circuit capacity (MVA) at connection point Pre-fault active power output at connection point Pre-fault reactive power output at connection point Pre-fault voltage at connection point Post-fault minimum short circuit capacity (MVA) at connection point (only type D)	G	G	TSO			
4	Fault Ride Through Capability	-	<u>14(3)(b)</u> (Voltage-against- time profile for asymmetric faults)	B,C,D	SPGM: Uret, Uclear,Urec1,Urec2 tret, tclear, trec1, trec2, trec3	G	G	TSO			
5	Fault Ride Through Capability	-	<u>14(3)(b)</u> (Voltage-against- time profile for asymmetric faults)	B,C,D	PPM: Uret, Uclear, Urec1, Urec2 tret, tclear, trec1, trec2, trec3	G	G	TSO			
6	Fault Ride Through Capability	-	<u>16(3)(a)(i)</u> (Voltage-against- time profile)	D	SPGM: Uret, Uclear,Urec1,Urec2 tret, tclear, trec1, trec2, trec3	G	G	TSO			
7	Fault Ride Through Capability	-	<u>16(3)(a)(i)</u> (Voltage-against- time profile)	D	PPM: Uret, Uclear, Urec1, Urec2 tret, tclear, trec1, trec2, trec3	G	G	TSO			
8	Fault Ride Through Capability	-	<u>16(3)(c)</u> (Voltage-against- time profile for asymmetric faults)	D	SPGM: Uret, Uclear,Urec1,Urec2 tret, tclear, trec1, trec2, trec3	G	G	TSO			

Technical Assistance for the Connection Network Codes implementation in the Energy Community

9	Fault Ride Through Capability	-	16(3)(c) (Voltage-against-time profile for asymmetric faults)	D	PPM: Uret, Uclear, Urec1, Urec2 tret, tclear, trec1, trec2, trec3	G	G	TSO			
10	Fault Ride Through Capability	-	16(3)(b)(i)	D	Pre-fault minimum short circuit capacity (MVA) at connection point	G	G	TSO			
11	Fault Ride Through Capability	-	16(3)(b)(ii)	D	Pre-fault active power output at connection point Pre-fault reactive power output at connection point Pre-fault voltage at connection point	G	G	TSO			
12	Fault Ride Through Capability	-	16(3)(b)(iii)	D	Post-fault minimum short circuit capacity (MVA) at connection point	G	G	TSO			
13	Automatic Disconnection due to Voltage Level	-	15(3)	C	Voltage criteria for automatic disconnection Settings for automatic disconnection	G	S (value)	RSO (DSO or TSO), in coordination with the TSO			
14	Voltage Ranges PGM U<300kV	-	16(2)(a)(i)	D	Time period for operation: 1.118pu-1.15pu (SAs: CE)	G	G (value)	TSO	Table is shown in Gap analysis	[37], point 57.	not in line with REGULATION (EU) 2016/631 of 14 April 2016 ESTABLISHING A NETWORK CODE ON REQUIREMENTS FOR GRID CONNECTION OF GENERATORS, incorporated and adapted by Permanent High Level Group Decision 2018/03/PHLG-EnC
15	Voltage Ranges PGM U<300kV	X	16(2)(a)(iii)	D	Shorter time period in the event of simultaneous overvoltage and under frequency Shorter time period in the event of simultaneous undervoltage and over frequency	G	S	TSO			
16	Voltage Ranges PGM U<300kV	-	16(2)(b)	D	Wider voltage ranges for operation may be agreed by RSO, PGFO and TSO Longer minimum time periods for operation may be agreed by RSO, PGFO and TSO	S	S	Agreement between the RSO and the PGFO, in coordination with the TSO			
17	Voltage Ranges PGM 300kV < U <400kV	-	16(2)(a)(i)	D	Time period for operation 1.05pu-1.10pu (SAs: CE; Nordic)	G	S	TSO	Table is shown in Gap analysis	[37], point 57.	not in line with COMMISSION not in line with REGULATION (EU) 2016/631 of 14 April 2016 ESTABLISHING A NETWORK CODE ON REQUIREMENTS FOR GRID CONNECTION OF GENERATORS, incorporated and adapted by Permanent High Level Group Decision
18	Voltage Ranges PGM 300kV < U <400kV	X	16(2)(a)(ii)	D	Shorter time period in the event of simultaneous overvoltage and under frequency Shorter time period in the event of simultaneous undervoltage and over frequency	G	S	TSO			

Technical Assistance for the Connection Network Codes implementation in the Energy Community

19	Voltage Ranges PGM 300kV < U < 400kV	-	<u>16(2)(b)</u>	D	Wider voltage ranges for operation may be agreed by RSO, PGFO and TSO Longer minimum time periods for operation may be agreed by RSO, PGFO and TSO	S	S (value)	Agreement between the RSO and the PGFO, in coordination with the TSO			
20	Reactive Power Capability SPGM	X	<u>17(2)(a)</u>	B	Capability to supply or absorb reactive power	G	G (range)	RSO			
21	Supplementary Reactive Power SPGM	X	<u>18(2)(a)</u>	C,D	Definition of supplementary reactive power to compensate reactive power demand of the HV line or cable when connection point is not located at the HV side of the step-up transformer	G	G (range)	RSO			
22	Reactive Power Capability SPGM at max. Capacity	-	<u>18(2)(b)(i)</u>	C,D	U-Q/Pmax-profile at maximum capacity	G	G (range of capability)	RSO in coordination with the TSO			
23	Reactive Power Capability SPGM at max. Capacity	-	<u>18(2)(b)(iv)</u>	C,D	Appropriate timescale to reach any operating point within U- Q/Pmax-profile	G	G (value)	RSO			
24	Voltage Control SPGM	-	<u>19(2)(a)</u>	D	Parameters and settings of the components of the voltage control system Specifications of the automatic voltage regulator (AVR)	G	S (ranges)	Agreement between the PGFO and the RSO, in coordination with the TSO			
25	Voltage Stability SPGM	-	<u>19(2)(b)(v)</u>	D	Power threshold above which PSS function must be specified	G	G (value)	TSO			
26	Reactive Power Capability PPM	X	<u>20(2)(a)</u>	B,C,D	Capability to supply or absorb reactive power	G	G (range of capability)	RSO			
27	Fast Fault Current PPM	X	<u>20(2)(b)(ii)</u>	B,C,D	How the voltage deviation is determined? When the voltage deviation is determined? Characteristics of fast fault current injection Timing of fast fault current injection which may include several stages Accuracy of fast fault current injection which may include several stages The end of the voltage deviation	G	G (values)	RSO in coordination with the TSO			
28	Fast Fault Current PPM	X	<u>20(2)(c)</u>	B,C,D	Specification for asymmetrical current injection (in case of asymmetrical faults 1-phase/2-phase faults)	G	G (value)	RSO in coordination with the TSO			
29	Supplementary Reactive Power PPM	X	<u>21(3)(a)</u>	C,D	Definition of supplementary reactive power to compensate reactive power demand of the HV line or cable when connection point is not located at the HV side of the step-up transformer	G	G (range)	RSO			
30	Reactive Power PPM at max. Capacity	-	<u>21(3)(b)</u>	C,D	U-Q/Pmax- at maximum capacity	G	G (range of capability)	G (range of capability)			
31	Reactive Power PPM below max. Capacity	-	<u>21(3)(c)(i)</u>	C,D	U-Q/Pmax-profile below maximum capacity	G	G (range of capability)	RSO in coordination with the TSO			
32	Reactive Power PPM below max. Capacity	-	<u>21(3)(c)(iv)</u>	C,D	Appropriate timescale to reach any operating point within U- Q/Pmax-profile	G	G (value)	RSO			

Technical Assistance for the Connection Network Codes implementation in the Energy Community

33	Reactive Power Control Modes PPM	-	<u>21(3)(d)(iv)</u> (Voltage control mode)	C,D	t1: time within which 90% of the change in reactive power is reached t2: time within which 100% of the change in reactive power is reached	G	G (values)	RSO			
34	Reactive Power Control Modes PPM	-	<u>21(3)(d)(vi)</u> (Power factor control mode)	C,D	Target power factor Time period to reach the set point Tolerance	G	G (ranges)	RSO			
35	Reactive Power Modes PPM	-	<u>21(3)(d)(vii)</u> (Specifications of the two reactive power control mode options)	C,D	Which reactive power control mode is chosen? Which associated set points are applied? Which further equipment is needed to make the relevant set point operable?	S	S	RSO, in coordination with the TSO and the PGFO			
36	Priority Active or Reactive Power Contribution PPM	-	<u>21(3)(e)</u> (Provision of active power no later than 150ms from fault inception)	C,D	Priority for active or reactive power contribution during faults for which fault-ride-through capability is required	G	G	relevant TSO			
37	PPM Power oscillations damping	X	<u>21(3)(f)</u>	C,D	Power oscillations damping by the power park module	G	S	relevant TSO			
38	Voltage Ranges Offshore PPM U<300kV	-	25(1)	Offshore PPM	Time period for operation: 1.118pu-1.15pu (SAs: CE)	G	G (value)	TSOI			
39	Voltage Ranges Offshore PPM 300kV< U <400kV	-	25(1)	Offshore PPM	Time period for operation: 1.05pu-1.10pu (SAs: CE, Nordic)	G	G (value)	TSO			
42	Reactive Power Capability PPM Offshore at max Capacity	-	25(5)	Offshore PPM	U-Q/Pmax- at Pmax	G	G (range of capability)	TSO			

Technical Assistance for the Connection Network Codes implementation in the Energy Community

FCN	Non-exhaustive Requirement	Non mandatory Requirement	DCC NC Article No.	Applicability	Parameters/ Ranges/Values	Timing of Proposal		Proposer	DCC_Voltage_Issues -Moldova		
						Requirement as such	Values/Range of Requirement		Definition of Parameters/ Ranges/Values at national level	Defined in document/Article No.	Comments
1	Voltage Ranges	-	13(1) and Annex II	TC DF and TC DS in range 110 kV – 300 kV	Time period for: 1,05 pu – 1,10 pu (SAs: Nordic) 1,118 pu – 1,15 pu (SAs: CE, Baltic)	G	G (value)	TSO	Table is shown in Gap analysis	[37], point 204.	not in line with COMMISSION REGULATION (EU) 2016/1388 of 17 August 2016 ESTABLISHING A NETWORK CODE ON DEMAND CONNECTION, incorporated and adapted by Permanent High Level Group Decision 2018/05/PHLG-EnC of 12 January 2018
2	Voltage Ranges	-	13(1) and Annex II	TC DF and TC DS 300 kV – 400 kV	Time period for: 1,05 pu – 1,10 pu (SAs: CE, Nordic, GB) 1,097 pu – 1,15 pu (SAs: Baltic)	G	G (value)	TSO	Table is shown in Gap analysis	[37], point 204.	not in line with COMMISSION REGULATION (EU) 2016/1388 of 17 August 2016 ESTABLISHING A NETWORK CODE ON DEMAND CONNECTION, incorporated and adapted by Permanent High Level Group Decision 2018/05/PHLG-EnC of 12 January 2018
3	Automatic disconnection due to voltage level	x	13(6)	TC DF and TC DS	Voltage criteria parameters at the connection point for automatic disconnection Technical parameters at the connection point for automatic disconnection	S	S (value)	agreement between relevant: TC DFO or TC DSO and TSO			
4	Voltage Ranges	-	13(7)	TC DS below 110 kV	Voltage range at the connection point that the TC DS shall be designed to withstand.	G	G	relevant TSO			
5	Reactive power capability for TC DF and TC DS	-	15(1)(a)	TC DF	Definition of the actual reactive power range for DF without onsite generation	G	S (value)	relevant TSO			
6	Reactive power capability for TC DF and TC DS	-	15(1)(b)	TC DS	Definition of the actual reactive power range for DF with onsite generation	G	S (value)	relevant TSO			
7	Reactive power capability for TC DF and TC DS	-	15(1)(c)	TC DS	Definition of the scope of the analysis to find the optimal solution for reactive power	S	S (at connection application)	agreement between relevant TSO and TC DSO			

8	Reactive power capability for TC DF and TC DS	X	15(1)(d)	TC DF and TC DS	Definition of other metrics than power factor	G	S (value)	relevant TSO			
9	Reactive power capability for TC DF and TC DS	X	15(2)	TC DS	Reactive power capability for transmission connected distribution systems not to export reactive power at less than 25% of the maximum import capability	S	S	relevant TSO			
10	Reactive power capability for TC DF and TC DS	X	15(3)	TC DS	Method to carry out active control the exchange of reactive power at the connection point	S	S	agreement between relevant TSO and TC DSO			
11	Reactive power capability for TC DF and TC DS	X	15(4)	TC DS	Consideration of TC DS for reactive power management	S	S	TC DSO may require it from relevant TSO			
12	DRS	X	28(2)(c)	DU offering DRS	For DF or CDS connected below 110 kV: Definition of the normal operating range	G	G (value)	RSO			
13	DRS	X	28(2)(e)	DU offering DRS	Technical specifications to enable the transfer of information for DR LFDD and Low Voltage Demand Disconnection (LVDD), for DR Active Power Control (APC) and DR Reactive Power Control	G	G (value)	RSO			
14	DRS	X	28(2)(f)	DU offering DRS	Definition of the time period to adjust the power consumption	G	G (value)	RSO or relevant TSO			
15	DRS	X	28(2)(i)	DU offering DRS	Definition of the modalities of notification in case of a modification of the DR capability	G	G (value)	RSO or relevant TSO			
16	DRS	X	28(2)(k)	DU offering DRS	Definition of the ROCOF maximum value	G	G (value)	relevant TSO			
17	Power quality	-	20	TC DF and TC DS at the connection point	Allocated level of voltage distortion	G (principle)	S (value)	relevant TSO			

SETTING OF METHODOLOGIES FOR DETERMINATION OF NON-EXHAUSTIVE REQUIREMENTS

List of Abbreviations

ACE	- Area Control Error
AGC	- Automatic Governor Control
APC	- Active Power Control
AVR	- Automatic Voltage Regulator
CCGT	- Combined Cycle Gas Turbine
CDS	- Closed Distribution System
CDSO	- Closed Distribution System Operator
CE	- Continental Europe
CE SA	- Continental Europe Synchronous Area
CNC	- Connection Network Codes
DCC	- Demand Connection Code
DF	- Demand Facility
DR	- Demand Response
DRS	- Demand Response Service
DR SFC	- Demand Response System Frequency Control
DS	- Distribution System
DSO	- Distribution System Operator
DU	- Demand Unit
EMF	- Electromotive Force
EnC	- Energy Community
ENTSO-E	- European Network of Transmission System Operators for Electricity
EU	- European Union
FCR	- Frequency Containment Reserves
FRR	- Frequency Restoration Reserves
FRT	- Fault Ride Through
FSM	- Frequency Sensitivity Mode
HVDC	- High Voltage Direct Current
HPP	- Hydro Power Plant
IGD	- Implementation Guidance Document
LFDD	- Low Frequency Demand Disconnection
LFSM	- Limited Frequency Sensitivity Mode
LFSM -O	- Limited Frequency Sensitivity Mode - Overfrequency
LFSM -U	- Limited Frequency Sensitivity Mode - Underfrequency
LV	- Low Voltage
NC	- Network Codes

NRA	- National Regulatory Authority
PE	- Power electronics
PEIPS	- Power Electronics Interfaced Power System
PGFO	- Power Generating Facility Owner
PGM	- Power Generating Module
PHLG	- Permanent High Level Group
PPM	- Power Park Module
PSHPP	- Pumped Storage Hydro Power Plant
PSS	- Power System Stabilizer
RES	- Renewable Energy Sources
RfG	- Requirements for Generators
RLPI	- RES Load Penetration Index
RoCoF	- Rate-of-Change-of-Frequency
RPC	- Reactive Power Control
RSO	- Relevant System Operator
SA	- Synchronous Area
SPGM	- Synchronous Power-Generating Module
SFC	- System Frequency Control
SPGM	- Synchronous Power-Generating Module
SPP	- Solar Power Plant
TC DF	- Transmission connected Demand Facility
TC DS	- Transmission Connected Distribution System, including Transmission Connected Distribution Facilities
TS	- Transmission System
TSO	- Transmission System Operator
TPP	- Thermal Power Plant
WTG	- Wind Turbine Generator
WPPG	- Wind Power Plant

Definitions

Closed Distribution System	a distribution system classified as a closed distribution system by national regulatory authorities or by other competent authorities, where so provided by the EnC contracting party, which distributes electricity within a geographically confined industrial, commercial or shared services site and does not supply household customers, without prejudice to incidental use by a small number of households located within the area served by the system and with employment or similar associations with the owner of the system;
Connection point	the interface at which the PGM, demand facility, distribution system or HVDC system is connected to a transmission system, offshore network, distribution system, including closed distribution systems, or HVDC system, as identified in the connection agreement;
Demand facility	a facility which consumes electrical energy and is connected at one or more connection points to the transmission or distribution system. A distribution system and/or auxiliary supplies of a power generating module do not constitute a demand facility;
Demand unit	an indivisible set of installations containing equipment which can be actively controlled by a demand facility owner or by a CDSO, either individually or commonly as part of demand aggregation through a third party;
Grid User	assets/facilities and their owners connected to transmission or distribution networks;
Low Frequency Demand Disconnection	an action where demand is disconnected during a low frequency event in order to recover the balance between demand and generation and restore system frequency to acceptable limits;
Maximum capacity	the maximum continuous active power which a PGM can produce, less any demand associated solely with facilitating the operation of the PGM and not fed into the network as specified in the connection agreement or as agreed between the relevant system operator and the PGFO (usually noted as Pmax);
Maximum Export Capability	the maximum continuous active power that a transmission-connected demand facility or a transmission-connected distribution facility, can feed into the network at the connection point, as specified in the connection agreement or as agreed between the relevant system operator and the transmission-connected demand facility owner or transmission-connected distribution system operator respectively;
Maximum Import Capability	the maximum continuous active power that a transmission-connected demand facility or a transmission-connected distribution facility can consume from the network at the connection point, as specified in the connection agreement or as agreed between the relevant system operator and the transmission-connected demand facility owner or transmission-connected distribution system operator respectively;

Closed distribution system	a distribution system classified as a closed distribution system by national regulatory authorities or by other competent authorities, where so provided by the EnC contracting party, which distributes electricity within a geographically confined industrial, commercial or shared services site and does not supply household customers, without prejudice to incidental use by a small number of households located within the area served by the system and with employment or similar associations with the owner of the system;
Transmission-connected distribution system'	a distribution system connected to a transmission system, including transmission-connected distribution facilities;
Maximum import capability'	the maximum continuous active power that a transmission-connected demand facility or a transmission-connected distribution facility can consume from the network at the connection point, as specified in the connection agreement or as agreed between the relevant system operator and the transmission- connected demand facility owner or transmission-connected distribution system operator respectively;
Maximum export capability	the maximum continuous active power that a transmission-connected demand facility or a transmission-connected distribution facility, can feed into the network at the connection point, as specified in the connection agreement or as agreed between the relevant system operator and the transmission- connected demand facility owner or transmission-connected distribution system operator respectively;
Low frequency demand disconnection	an action where demand is disconnected during a low frequency event in order to recover the balance between demand and generation and restore system frequency to acceptable limits;

1. Introduction

Methodologies given in this report aim at helping TSO and DSO of each Contracting Party to develop and implement non-exhaustive requirements given in the CNC Regulations ([1], [2]) applicable at EnC level. The methodological approach for determining non-exhaustive parameters will be clustered in 4 categories, i.e. frequency related requirements, voltage related requirements, system restoration related requirements and instrumentation, simulation models and protections, for both RfG and DCC.

As pointed out in [7] major contributing factor for determining non-exhaustive requirements are current and future power system characteristics at national level. In the process of harmonization with CNC requirements, one must take great care not to jeopardize achieved level of operational security. Therefore in the process of harmonization of existing national transmission and distribution grid codes, and defining non-exhaustive requirements it is good approach to examine requirements already existing at national level. If some of the already existing requirements are compliant with CNC requirements, they can be, and most likely should be kept, because existing requirements have benefit of being tested against operational procedures at national levels. Also, these requirements should have been approved by the NRA, and should have passed public scrutiny of interested stakeholders (mainly grid users). Nevertheless, if there is concern regarding some of the existing requirements or some of the parameter values, even if they are compliant with CNC, this shall be reviewed in the report. This also applies for some of the requirements or parameters pointed out by the Contracting Party representatives. Therefore when defining non-exhaustive requirements approach presented in Figure 11 shall be followed.

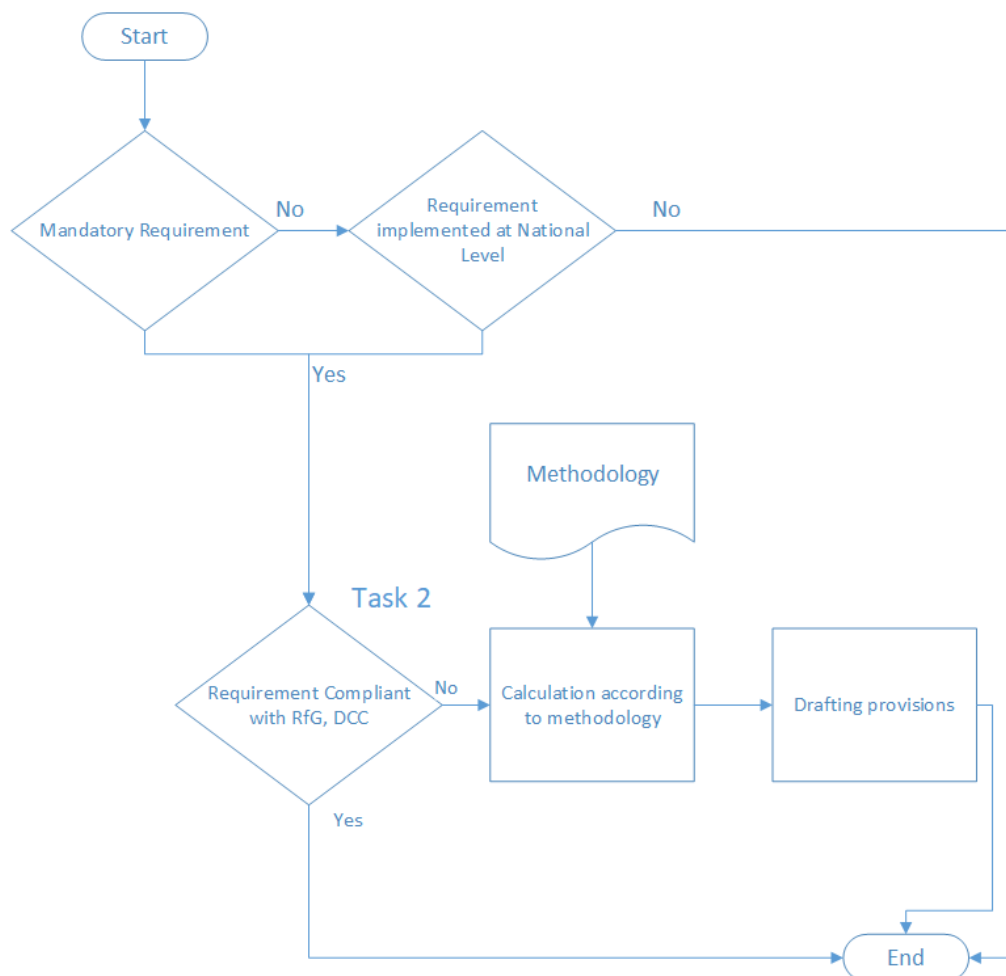

Figure 11 - Determining non-exhaustive requirements at national level

Besides taking care that achieved operational security is not jeopardized, great care must be taken in order to ensure that achieved level of system operational security is going to be at least maintained, if not improved in future. Therefore it is important to have in mind future power system characteristics,

i.e. mainly transmission and distribution network characteristics and generation portfolio. In the countries that do not have possibilities to construct large scale WPPs and SPPs, the power systems shall transition from bulk generation from larger transmission connected generation units to distributed RES generating units, mainly connected to distribution network. Even though EnC countries maybe at the moment do not experience this transition, close collaboration and coordination between TSO and DSO becomes one of the focal points for implementation of CNC.

As pointed out in [16] non-mandatory requirements do not have to be implemented at national level. It is up to each TSO/DSO to decide whether or not to implement these requirements. It should be pointed out however that each of the non-mandatory requirement can be made mandatory at national level, at any point of time after CNC are implemented. List of the non-mandatory requirements from RfG and DCC, is given in Appendix 1 of the report. When deciding whether or not to implement some of the non-mandatory requirements it should be considered whether or not this requirement is needed in order to maintain achieved system operational security or to improve system security in the future. Regarding future needs, the main starting point should be system development plans. They should reflect national energy and environmental strategies that will have major influence on the power system characteristics. As recommended in [16] when considering future needs time period of 15-20 years should be considered, because this corresponds to the expected lifetime of newly connected RES facilities (SPPs and WPPs). This time period corresponds to long-term system planning. Therefore for some of the requirements it may be beneficiary to develop more detailed long-term system studies in order to demonstrate system needs for some of the non-mandatory requirements, investigating beside system needs, effects of the requirement on future system users (i.e. cost-benefit analysis), technical capabilities of connecting facilities etc. Even though these studies, are most likely to be governed by RSO [16], all of the relevant stakeholders (i.e. other TSOs, DSO, system users, PGFO etc.) should be included in the process.

As stated in [16], non-exhaustive parameters *“for any requirement may be varied across different types of significant grid users”*, and they also *“may be applied regionally”*. Either way it is important that applied approach is justified and in compliance with CNC. In no case national grid codes should be contradictory to CNC requirements.

2. Methodology for RfG Non-Exhaustive Requirements

2.1. Determination of significance

Article
<p>5 „1. The power-generating modules shall comply with the requirements on the basis of the voltage level of their connection point and their maximum capacity according to the categories set out in paragraph 2.</p> <p>2. Power-generating modules within the following categories shall be considered as significant: (a) connection point below 110 kV and maximum capacity of 0,8 kW or more (type A); (b) connection point below 110 kV and maximum capacity at or above a threshold proposed by each relevant TSO in accordance with the procedure laid out in paragraph 3 (type B). This threshold shall not be above the limits for type B power-generating modules contained in Table 1; (c) connection point below 110 kV and maximum capacity at or above a threshold specified by each relevant TSO in accordance with paragraph 3 (type C). This threshold shall not be above the limits for type C power-generating modules contained in Table 1; or (d) connection point at 110 kV or above (type D). A power-generating module is also of type D if its connection point is below 110 kV and its maximum capacity is at or above a threshold specified in accordance with paragraph 3. This threshold shall not be above the limit for type D power-generating modules contained in Table 1.</p> <p>3. Proposals for maximum capacity thresholds for types B, C and D power-generating modules shall be subject to approval by the relevant regulatory authority or, where applicable, the Member State. In forming proposals the relevant TSO shall coordinate with adjacent TSOs and DSOs and shall conduct a public consultation in accordance with Article 10. A proposal by the relevant TSO to change the thresholds shall not be made sooner than three years after the previous proposal.</p> <p>4. Power-generating facility owners shall assist this process and provide data as requested by the relevant TSO.</p> <p>5. If, as a result of modification of the thresholds, a power-generating module qualifies under a different type, the procedure laid down in Article 4(3) concerning existing power-generating modules shall apply before compliance with the requirements for the new type is required.“</p>
<p>Applicability: Type A, B, C and D PGMs</p>

Mandatory

With regard to applicability of RfG requirements the main starting point is classification of PGMs according to their installed capacity and connection point. Relevant requirements for classification of the PGMs are given in RfG Article 5. Proposal for threshold levels is given by the TSO in coordination with adjacent TSOs and DSO, and with the assistance of PGFOs. The proposal should be subjected to public consultation, and at the end approved by the NRA. Once set, threshold levels can be changed if needed, but not sooner than three years after previous provisions are set. Possibility for periodical review allow TSOs to adopt threshold levels to the current system state. When threshold levels are changed, the procedure for application of RfG requirements to existing PGMs must be followed, as given in RfG Article 4.

Distinction between PGM types is made according to installed capacity and set threshold levels, and voltage level at connection point. Regarding voltage level threshold, this requirement is set as exhaustive, and all the modules connected at voltage level higher or equal to 110 kV are classified as type D PGMs. With regard to power capacity thresholds, this requirement is set as non-exhaustive allowing each TSO to define these boundaries, but maximum levels above which PGM is considered to be of type B, C or D are defined, in RfG Table 1, here given as Table 5.

Table 5 - Limits for power thresholds for type B, C and D PGMs according to RfG Article 5

Synchronous area	Limit for maximum capacity threshold from which a power generating module is of type B	Limit for maximum capacity threshold from which a power generating module is of type C	Limit for maximum capacity threshold from which a power generating module is of type D
Continental Europe	1 MW	50 MW	75 MW
Great Britain	1 MW	50 MW	75 MW
Nordic	1.5 MW	10 MW	30 MW
Ireland and Northern Ireland	0.1 MW	5 MW	10 MW
Baltic	0.5 MW	10 MW	15 MW

Requirements given in RfG for Continental Europe, should be read as follows:

- A. Type A PGM are all PGMs connected below 110 kV and with maximum capacity of 0.8 kW or more, but not more than set threshold capacity value for type B PGMs;
- B. Type B PGM are all PGMs connected below 110 kV and with maximum capacity at or above 1 MW, but not more than set threshold capacity value for type C PGMs;
- C. Type C PGM are all PGMs connected below 110 kV and with maximum capacity at or above 50 MW, but not more than set threshold capacity value for type D PGMs;
- D. Type D PGM are all PGMs connected at or above 110 kV and PGMs connected below 110 kV with maximum capacity at or above 75 MW.

According to EnC decision [1] in the case of Ukraine values from Table 5 applicable to SA Continental Europe are applicable. According to the same decision values from Table 5 applicable to SA Nordic are applicable to Georgia, and in the case of Moldova values from Table 5 applicable to SA Baltic are applicable. Given values does not prevent TSO to lower threshold levels if deemed necessary. Graphical representation of maximum capacity thresholds is given in Figure 12.

When implementing this requirement at national level existing practices at each Contracting Party should be considered. Even if thresholds at national level are not implemented as requested by the RfG it should be checked with Contracting Party representatives if there is existing practice regarding minimum generating capacity above which PGMs are connected at or above 110 kV network (or in other words what is the maximum capacity that is allowed to be connected at voltage levels below 110 kV). This value should be starting point when defining P_D . If at any given country this value is lower than RfG's 75 MW threshold limit, than TSO can consider this value to be adopted as threshold limit.

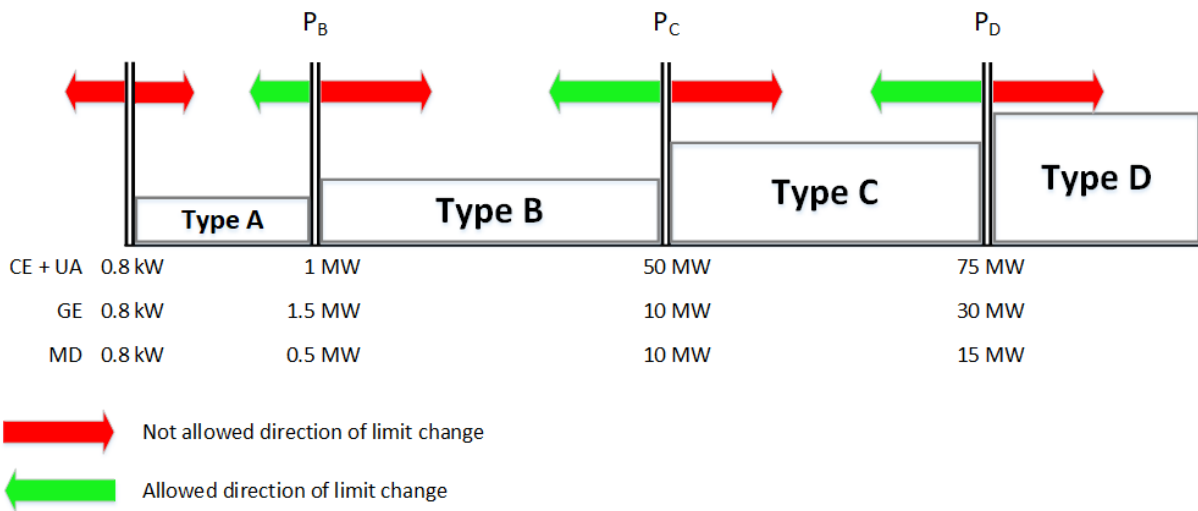

Figure 12 - Maximum capacity threshold according to RfG Article 5 and allowable direction of change

In this way existing practice that is based on operational experience and system planning criteria is respected. Other things to consider when defining P_D are differences in requirements applicable to type D PGMs and type C PGMs. In case of type D and type C, the main difference is regarding required robustness of PGMs during secured faults i.e. required FRT capability. Most demanding FRT requirement⁶ for type D PGMs requires PGMs to be more robust for secured symmetrical faults than most demanding type C FRT requirement. This difference in FRT requirement is more pronounced in FRT requirement for SPGMs (see Figure 13) than it is in the case of PPMs (see Figure 14). If it is expected to have significant amount of mid-power SPGMs (HPP or biomass plants) connected to voltage levels below 110 kV, than it would be reasonable to consider lowering value for P_D . However it should be noted that SPGMs FRT capability is greatly dependent on generators overall inertia, that gets lowered as power decreases.

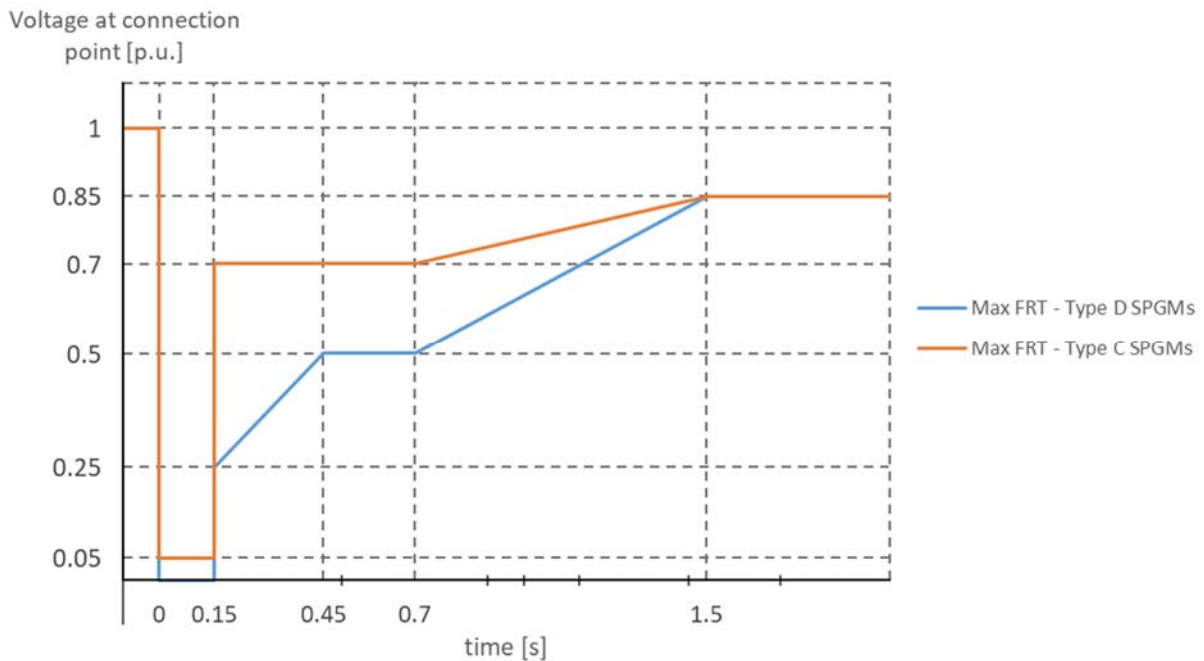

Figure 13 - Maximum FRT requirements for type C and D SPGMs

⁶ Voltage against time profile with highest allowable time parameter values and lowest voltage parameter values

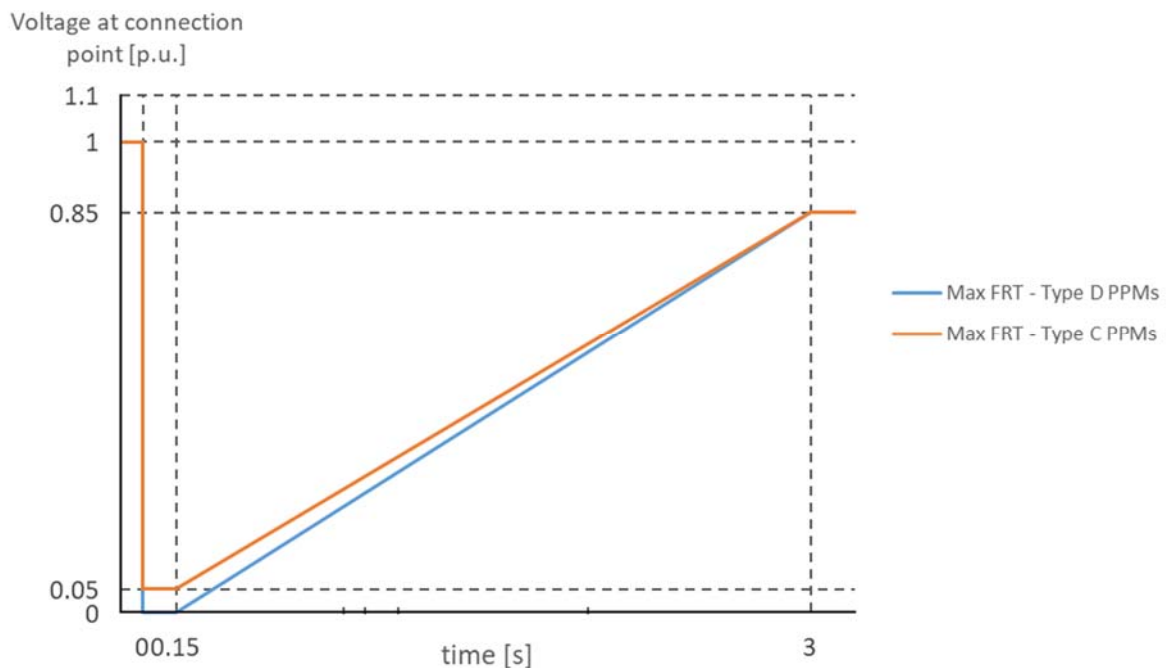

Figure 14 - Maximum FRT requirements for type C and D PPMs

When determining P_C , main thing to consider are the differences in requirements applicable to type C PGMs and type B PGMs. When considering type B and type C requirements, major difference is in frequency stability requirements given in RfG Article 15.(2). Type C PGMs should be able to adjust active power production according to RSO demand, to operate in FSM mode, and to implement LFSM-U. Having in mind that threshold limit will have greatest impact regarding system frequency stability, expected RES penetration including existing and expected RES support schemes, and TPP decommissioning scenarios, should be considered. Failure to recognize and account for system changes, such as maximum level of RES penetration may result in a shortage of capability of connected PGMs in a network to provide frequency response. If it is possible to have at any given point that majority of operating plants are RES plants than they will have to be capable to guaranty system secure operation regarding frequency stability. When considering lowest possible value for type C PGMs good criteria could be regarding planned controllability of lower power PGMs. According to Article 15.(2) type C PGMs should be capable to change active power output according to RSO's instruction, so as lower value for P_C , threshold value for units that should be under control of RSO (i.e. DSO or TSO) could be taken as value for P_C , if this threshold level provide sufficient margin regarding system frequency stability. The previous conclusion is made from the stand point of the TSO. On the other hand, TSO should also consider when defining this requirement DSO's need for voltage regulation from PGMs. Even though there are requirements regarding reactive power capabilities for both type B and type C PGMs, for type C PGMs (both SPGMs and PPMs) RfG gives possibility to define detailed requirement for reactive power capability at and below maximum capacity, according to the predefined envelopes (for SPGMs: RfG Figure 7, and Table 8, and for PPMs: RfG Figure 8 and Table 9 and Figure 9). If needed by the DSO previously determined value P_C , could be lowered.

With regard to P_B , main concern should be desired observability of small power PGMs connected to the system. Type B PGMs are required to exchange information with RSO in real time. Other significant difference between type A and B PGMs is that type B PGMs should be capable of FRT, and that RSO and PGFO need to agree on PGMs protection settings. When deciding if the P_B value should be lowered below 1 MW expected number of small power PGMs (below 1 MW), RSO's (mainly DSO's) plans for system observability (i.e. whether RSO plans to collect information from these modules in real time) should be considered.

Regarding TSO and DSO coordination the most crucial coordination is in the case of determining P_D and P_C values. Even though type C PGMs are going to be connected to distribution network these modules should have role in frequency control which is under TSO's jurisdiction. On the other hand requirements applicable to type D PGM's will be applicable to both PGM connected to transmission

network and large power PGM's connected to distribution network. Also, as previously stated amount of RES penetration will have impact when determining and re-examining threshold limits, so proper communication and collaboration between TSO and DSO regarding development plans and expected RES penetration is of great importance.

Once determined, threshold values should be re-examined as part of system development plans, because of the changes in the power system. If at any point seen necessary, procedure for changing threshold limits should be started. Keep in mind that this cannot be done sooner than three years after previous determination of PGM classification.

To summarize the difference between requirements applicable to types A/B, types B/C and types C/D, tables indicating these differences are given in Appendix 2 of the report.

2.2. Frequency Issues

2.2.1. Frequency Ranges

Non-exhaustive Requirement Frequency Ranges - time period for operation

“1. Type A power-generating modules shall fulfil the following requirements relating to frequency stability:

(a) With regard to frequency ranges:

(i) a power-generating module shall be capable of remaining connected to the network and operate within the frequency ranges and time periods specified in Table 2;”

Table 2: Minimum time periods for which a power-generating module has to be capable of operating on different frequencies, deviating from a nominal value, without disconnecting from the network

Table 6 - Frequency ranges and time periods

Articles 13(1)(a)(i), 13(1)(a)(ii):	Synchronous area	Frequency range	Time period for operation
	Continental Europe		47,5 Hz-48,5 Hz
		48,5 Hz-49,0 Hz	To be specified by each TSO, but not less than the period for 47,5 Hz-48,5 Hz
		49,0 Hz-51,0 Hz	Unlimited
		51,0 Hz-51,5 Hz	30 minutes
Georgia		47,0 Hz-47,5 Hz	20 seconds
		47,5 Hz-48,5 Hz	30 minutes
		48,5 Hz-49,0 Hz	60 minutes
		49,0 Hz-51,0 Hz	Unlimited
		51,0 Hz-51,5 Hz	30 minutes

Applicability: Type A, B, C and D PGMs

Mandatory

General

ENTSO-E 48,5 Hz-49,0 Hz time period between 30 min to unlimited, dominant 30 min.

Practice 47,5 Hz-48,5 Hz time period between 30 min to 90 min, dominant 30 min.

Regarding time periods that modules shall be capable to remain connected to the network and operate when the frequency is significantly lower than nominal, it is necessary to consider the following aspects:

- the time required for TSO dispatchers to react in emergency situations (existing operational practices, and estimated dispatch personnel response to frequency disturbance situations that have occurred in the past);
- technical limitations of PGM’s equipment.

Considering the frequency range 48.5 Hz-49.0 Hz, it is possible that the automatic LFSM-U function stops the frequency at the quasi-stationary value within this range, therefore it is necessary to consider the time required for the dispatchers to react in such situations. Normally, approx. 45 minutes should be enough for dispatchers to give first instructions after major disturbances. Assuming a margin of additional 15 minutes, a period of 60 minutes should be maximum duration of the observed range.

Considering the automatic functions of FSM and LFSM-U, it is less probable event that a quasi-stationary frequency value will be set on value lower than 48.5 Hz after disturbance. Therefore, it is technically justified to define time range sufficient for automatic response of FSM and LFSM-U functions for frequency ranges below 48.5 Hz. Time range sufficient for full response of FSM and LFSM-U functions is in the range between 30-60 seconds. However, the minimum time that needs to be set is significantly longer and it is recommended to leave it at the minimum value, on 30 minutes.

If we observe technical limitations of PGM’s equipment, the IEC 60034 on rotating electrical machines does provide a range of 47.5-51.5 Hz to be sustained for a limited time period without prescribing specific time periods (see Figure 15).

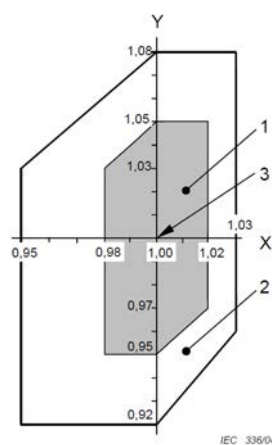

Figure 15 - Ranges from IEC 60034

Non-exhaustive Requirement	Frequency Ranges - Potential wider frequency ranges Potential longer minimum times Specific requirements for frequency and voltage deviations
Articles 13(1)(a)(i), 13(1)(a)(ii):	“1. Type A power-generating modules shall fulfil the following requirements relating to frequency stability: (a)With regard to frequency ranges: (ii) the relevant system operator, in coordination with the relevant TSO, and the power-generating facility owner may agree on wider frequency ranges, longer minimum times for operation or specific requirements for combined frequency and voltage deviations to ensure the best use of the technical capabilities of a power-generating module, if it is required to preserve or to restore system security;”
Applicability:	Type A, B, C and D PGMs
Non-mandatory	
Site specific	
ENTSO-E Practice	47 to 47.5Hz - 20 seconds and 51.5- 52Hz - 60minutes (Ireland and North Ireland) 51.5Hz-52.5Hz. In connection agreement for type B, C, D, based on technical capabilities. (Belgium)

When determining wider frequency ranges and/or longer times periods it is necessary to analyze black start operation and characteristic of PGMs providing black start ancillary services. If the black start simulation shows that the frequency values go beyond the prescribed ranges, the ranges need to be extended to the values obtained by the simulation. The obtained values shall be applied only to generation units that provide the black start ancillary service.

A wider frequency ranges or longer minimum time for operation should be implemented at national level if at least two of the following conditions are fulfilled:

- The system is located at periphery of interconnection;
- The system is weakly connected to the rest of interconnection;
- Exported or imported power makes a significant part of the energy portfolio.

Anyhow, a wider frequency ranges or longer minimum time for operation should be implemented only in accordance with duration of the automatic responses of the FCR and LFSM, which is not longer than 60 seconds, and not less than 40 seconds.

On figure below (Figure 16) typical response of Frequency Containment Control is shown. Quasi-stationary state is reach after approx. 50 seconds.

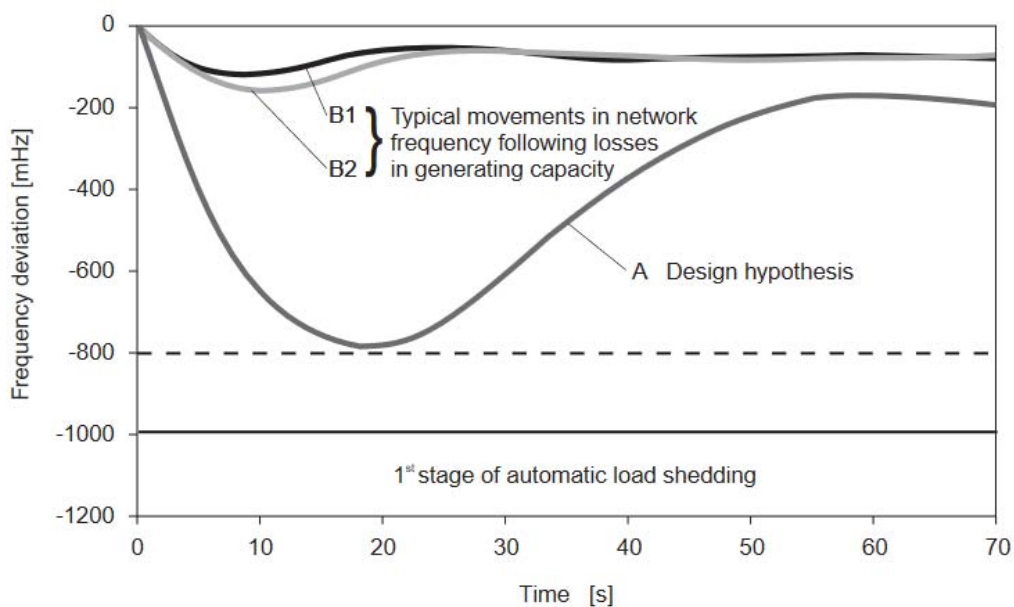

- A Loss in generating capacity: $P = 3000 \text{ MW}$, $P_{\text{network}} = 150 \text{ GW}$, self-regulating effect of load: $1\% / \text{Hz}$
 B1 Loss in generating capacity: $P = 1300 \text{ MW}$, $P_{\text{network}} = 200 \text{ GW}$, self-regulating effect of load: $2\% / \text{Hz}$
 B2 Loss in generating capacity: $P = 1300 \text{ MW}$, $P_{\text{network}} = 200 \text{ GW}$, self-regulating effect of load: $1\% / \text{Hz}$

Figure 16 - Typical FCR response [32]

2.2.2. Rate-of-Change-of-Frequency

Non-exhaustive Requirement	Rate-of-Change-of-Frequency - Max. RoCoF and measuring window for which PGM shall stay connected
Articles 13(1)(b)	<p>1. Type A power-generating modules shall fulfil the following requirements relating to frequency stability:</p> <p>(b)With regard to the rate of change of frequency withstand capability, a power-generating module shall be capable of staying connected to the network and operate at rates of change of frequency up to a value specified by the relevant TSO, unless disconnection was triggered by rate-of-change- of-frequency-type loss of mains protection. The relevant system operator, in coordination with the relevant TSO, shall specify this rate-of-change-of-frequency-type loss of mains protection.</p>
Applicability:	Type A, B, C and D PGMs
Mandatory	
General	
ENTSO-E Practice	RoCoF 1 Hz/s to 2.5 Hz/s Time Window 200 ms to 2000 ms.

Considering Rate-of-Change-of-Frequency, in order to determine limit value of RoCoF, it is necessary to analyze RoCoF during disturbances that occurred in the past. According to [32] frequency gradients in a range between 100 mHz/s up to 1Hz/s have been recorded in the CE interconnection.

Also, target ENTSO-E scenarios of system development with higher power exchanges and deployment of future generation technologies predict maximum imbalances of 40%, with maximum frequency gradient of 2 Hz/s.

According to ENTSO-E document [30], based on stakeholder survey results, RoCoF value could be problematic for the synchronous power generating modules because of mechanical limitations of individual synchronous machines (inherent capability) and protection devices triggered by a particular RoCoF threshold value.

The value of the RoCoF is used only in algorithms for early detection of island mode (thermal power plants, TPP) and less often for detection of operation in an isolated network (hydro power plants, HPP). It should be noted that there are no protection devices that consider RoCoF on synchronous generators.

Figure 17 and Figure 18 show load rejection simulation on typical HPP and TPP (for TPP island mode test is shown). The detection of overspeed is very important for synchronous units. It prevents turbine stress at high speed and prevents emergency trip of turbine.

The allowed overspeed on HPP is in the range of 30-60 % of rated speed. Because of the wide range of overspeed, for detection of load rejection overspeed threshold is usually used. For example, when speed is 3% above the rated speed and at the same time line or generator switches are open; this is a command for turbine controller to switch from load mode to speed mode.

The information about RoCoF could be included in this algorithm as well. From the Figure 17 it is possible to calculate RoCoF. Rate of change of turbine speed is about 6.95 %/s, thus RoCof is 3.47 Hz/s.

ENTSO-E recommends the following for RoCoF [30], based on studies done by RG-CE System Protection & Dynamics Sub Group:

- ± 2 Hz/s for moving average of 500ms window;
- $\pm 1,5$ Hz/s for moving average of 1000ms window;
- $\pm 1,25$ Hz/s for moving average of 2000ms window,

It can be concluded that maximum recommended RoCoF is 2Hz/s, which is sufficiently less than 3.47 Hz/s which is a value appropriate for HPP units.

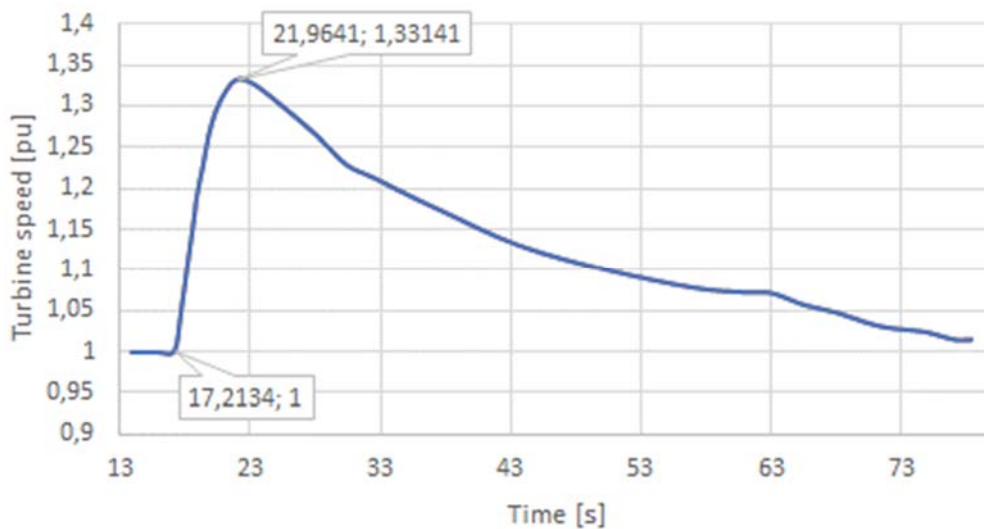

Figure 17 - Load rejection on typical HPP

Regarding thermal units, the allowed overspeed is usually 10 % of rated speed. The turbine controller switches from load to speed mode, if two out of the following three conditions are met:

- RoCoF is above defined value;
- Turbine speed is above 2% of rated speed;
- Line or generator switches are open.

From Figure 18 it is possible to calculate RoCoF. The rate of change of speed is about 4.61 %/s, that means that RoCof is 2.3 Hz/s. For on-time detection of overspeed by using RoCoF value, it is necessary to define a margin in relation to the maximum RoCoF that can occur. Assuming that this margin is 30%, a threshold for RoCoF shall be 1.6 Hz/s.

Considering that there could be differences in the construction of TPP units, a value of 1.5 Hz/s could be recommended as the appropriate minimum limit for RoCoF.

Other types of power generating modules have less stringent restrictions regarding to RoCoF, therefore power generating modules shall stay stable and connected to grid if RoCoF is less than 1.5 Hz/s.

The above-mentioned analysis refers to over speed situations. Considering that there are no special limits for RoCoF values in under speed situations, ENTSO-E recommendation for RoCoF of 2Hz/s should be implemented.

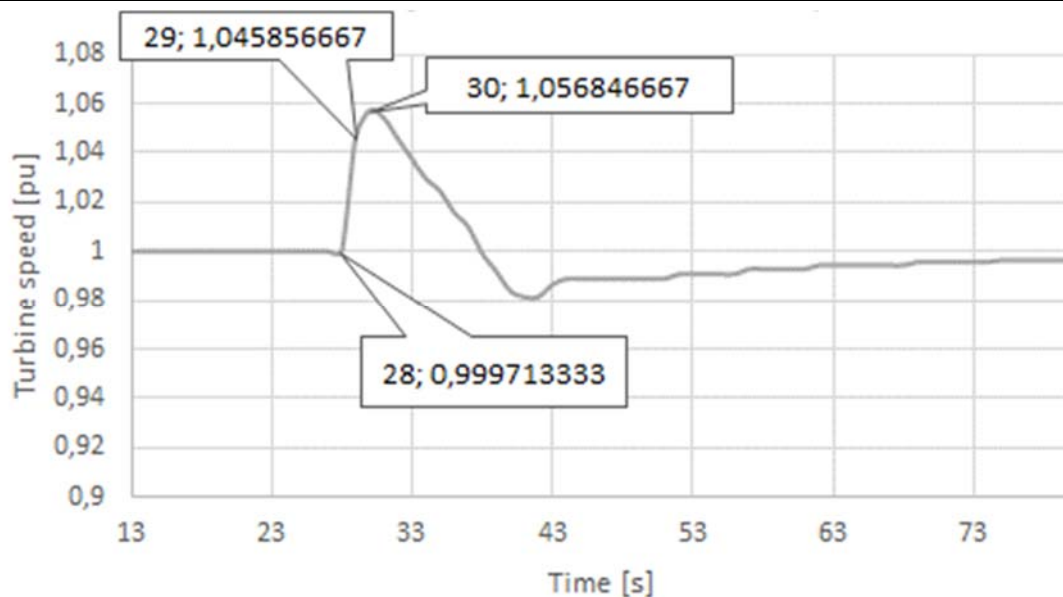

Figure 18 - Island mode test on TPP

Based upon the results of studies, performed by ENTSO-E System Protection & Dynamics Sub Group, the power generating modules shall stay stable and connected to grid if the rate of change of frequency in respect to their moving average time window is cumulatively equal or less than the following values:

- $\pm 2\text{Hz/s}$ for moving average of 500ms window,
- $\pm 1,5\text{Hz/s}$ for moving average of 1000ms window,
- $\pm 1,25\text{Hz/s}$ for moving average of 2000ms window.

It should be emphasized here that value for time window strongly depends from specific turbine controller characteristics, i.e. its cycle time of control algorithm. New turbine controllers use very fast cycle time (between 8-30 ms) and react after 2-5 cycles of measurements, therefore this value should not be higher than 150 ms.

Non-exhaustive Requirement	Rate-of-Change-of-Frequency - Specify RoCoF of the loss of main protection
Articles 13(1)(b)	<p>1. Type A power-generating modules shall fulfil the following requirements relating to frequency stability:</p> <p>(b)With regard to the rate of change of frequency withstand capability, a power-generating module shall be capable of staying connected to the network and operate at rates of change of frequency up to a value specified by the relevant TSO, unless disconnection was triggered by rate-of-change- of-frequency-type loss of mains protection. The relevant system operator, in coordination with the relevant TSO, shall specify this rate-of-change-of-frequency-type loss of mains protection.</p>
Applicability:	Type A, B, C and D PGMs
Mandatory	
Site specific	
ENTSO-E Practice	RoCoF 1Hz/s – 2.5 Hz/s Time Window 100 ms - 500 ms

Considering loss of mains protection, RoCoF value refers to eventual island operation conditions, therefore the RoCoF limit could be lower and time window could be narrower than for previous requirement.

It is recommended that RoCoF value remains at the same values (+1.5 Hz/s, -2 Hz/s), while time window could be less, 2 cycle time of turbine or speed/frequency measurement algorithms.

It is recommended that RoCoF value should not be the only condition for loss of mains protection. It should be combined with two other conditions:

- RoCoF is above define value (+1.5 Hz/s, -2 Hz/s) in two algorithm cycle times;
- Turbine speed/frequency is above 2% of rated speed or speed/frequency is less than 2% of rated speed;
- At least one of switches which separates PGM from the transmission network is open.

The recommended algorithm is shown on the figure below.

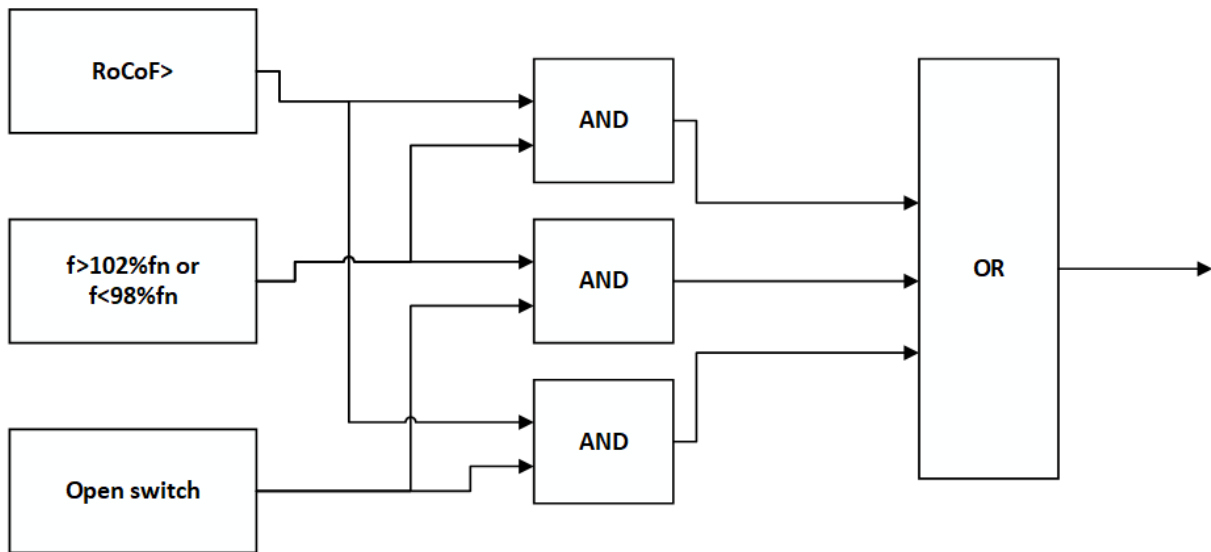

Figure 19 - Loss of Mains algorithm 2 of 3

2.2.3. Frequency Sensitive Mode

Non-exhaustive Requirement	Active power range related to maximum capacity
	Frequency response insensitivity
	Frequency response dead band

2) Type C power-generating modules shall fulfil the following requirements relating to frequency stability:

d) in addition to point (c) of paragraph 2, the following shall apply cumulatively when frequency sensitive mode ('FSM') is operating:

(i) the power-generating module shall be capable of providing active power frequency response in accordance with the parameters specified by each relevant TSO within the ranges shown in Table 4. In specifying those parameters, the relevant TSO shall take account of the following facts:

- in case of overfrequency, the active power frequency response is limited by the minimum regulating level,
- in case of underfrequency, the active power frequency response is limited by maximum capacity,
- the actual delivery of active power frequency response depends on the operating and ambient conditions of the power-generating module when this response is triggered, in particular limitations on operation near maximum capacity at low frequencies according to paragraphs 4 and 5 of Article 13 and available primary energy sources;

Ranges:

Active power range related to maximum capacity 1.5-10 %

Frequency response insensitivity 10-30 mHz

Frequency response dead band 0-500 mHz

Droop 2-12%

Articles 15(2)(d)(i)

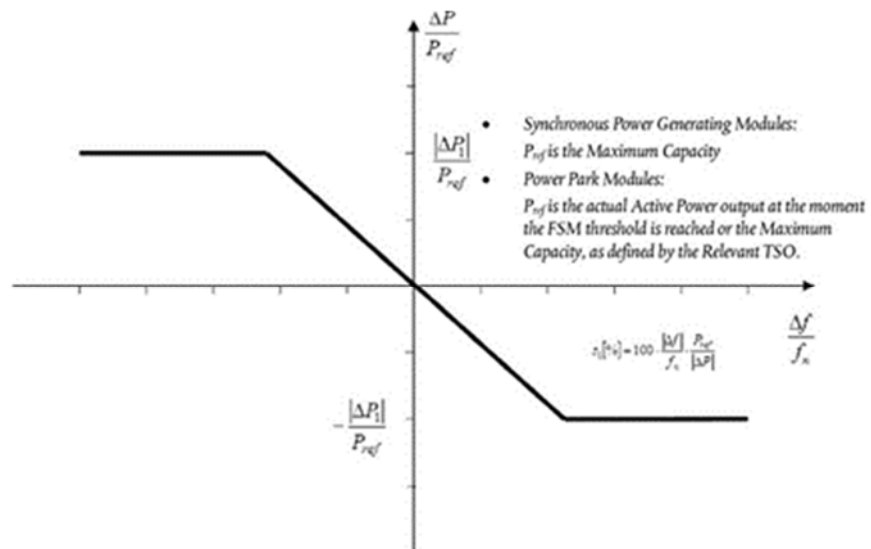

Figure 20 - FSM characteristic

Figure

Applicability: Type C and D PGMs

Mandatory

General range, site specific adjustable settings

**ENTSO-E
Practice**

Active power range related to maximum capacity: mostly the range 1.5-10%;
 Frequency response insensitivity: in general, 10 mHz
 Frequency response dead band: mostly ranges 0 - 500 mHz and 0 - 200 mHz, and when there is an exact value it is usually 0 mHz
 Droop: mostly the range 2-12%;

According to [37], frequency-related issues require a similar response within the same synchronous area. However, it should be noted that TSOs usually define range of parameters, rather than the exact values. In order to assess current practice, UCTE Policy 1 [36] is also considered. Current practice and current settings of turbine controllers are usually in line with UCTE recommendations:

- Active power range related to maximum capacity: reserve on ± 200 mHz
- Frequency response insensitivity + Frequency response dead band: 20 mHz
- Droop: not exactly defined, but in practice range 4-6 % is usually used depending on a type of synchronous machine (lower for hydro units, higher for turbogenerators);

Considering EnC member countries, FCR service providers will be probably hydropower plants and gas thermal power plants in the future period, assuming that coal-fired thermal power plants and nuclear power plants will be excluded from FCR due to their unstable responses and slow changes of load. These units could be used in LFSM-O mode.

According to [36], typically rate of change of load, for oil- or gas-fired power stations, is around 8% of rated power per minute. In the case of PSHPP and hydro power plants, the rate of continuous power change ranges from 1.5 to 2.5% of the rated plant output per second (more than 50% per minute).

Considering that FCR reserve should not exceed possible increase of output in one minute (because of stable response), available active power reserve for gas PGMs related to maximum capacity is estimated to about 8 %, while for hydro PGMs it is over 25 %, meaning that maximum limit of 10 % should be applied.

Considering that full amount of reserve shall be activated at ± 200 mHz and the equation for droop:

$$[\%] = 100 \cdot \frac{\Delta f / f_n}{\Delta P / P_{ref}} = 100 \cdot \frac{\Delta f \cdot P_{ref}}{\Delta P \cdot f_n}$$

- P_{ref} is the reference active power
- ΔP is the change in active power output from the power-generating module
- f_n is the nominal frequency (50 Hz) in the network
- Δf is the frequency deviation in the network.

it can be calculated that machine with active power reserve of 10 % should have a droop of 4%, while for machine with reserve of 8 %, droop should be 5 %.

Accordingly, it is recommended to define minimal droop of 4 % in a power systems with high participation of hydro units and 5 % droop in a system where gas-fired PGMs exist.

Regarding maximum frequency response insensitivity, insensitivity of ± 10 mHz could be applied due to digitization of the control process.

According to SOGL Art. 154, the maximum combined effect of inherent frequency response insensitivity and possible intentional frequency response dead band of the governor of the FCR providing units or FCR providing groups shall be ± 10 mHz (for Continental Europe synchronous area).

Non-exhaustive Requirement Maximum admissible full activation time

2) Type C power-generating modules shall fulfil the following requirements relating to frequency stability:

d) in addition to point (c) of paragraph 2, the following shall apply cumulatively when frequency sensitive mode ('FSM') is operating:

(iii) in the event of a frequency step change, the power-generating module shall be capable of activating full active power frequency response, at or above the full line shown in Figure 6 in accordance with the parameters specified by each TSO (which shall aim at avoiding active power oscillations for the power-generating module) within the ranges given in Table 5. The combination of choice of the parameters specified by the TSO shall take possible technology dependent limitations into account;

Articles 15(2)(d)(iii)

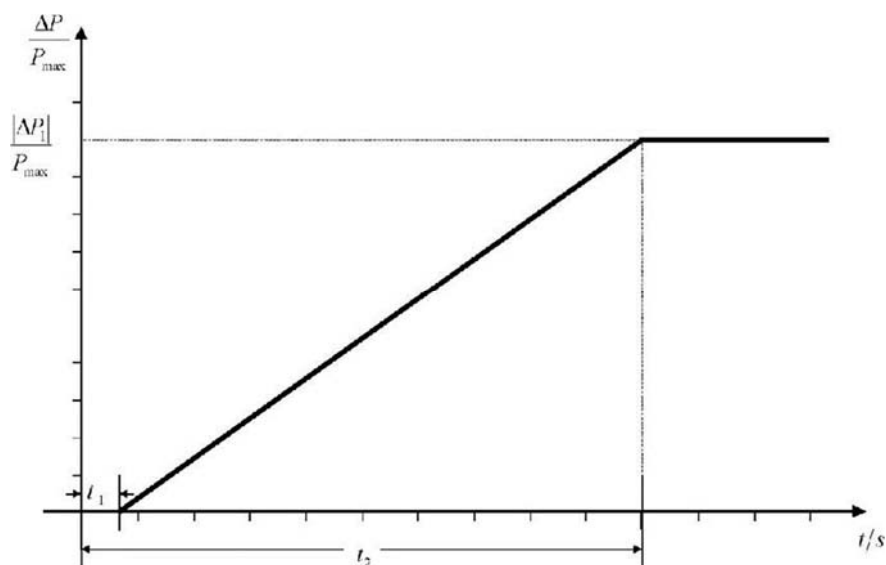

Figure 21 - FCR response characteristic

Applicability: Type C and D PGMs

Mandatory

General

ENTSO-E Practice Mostly 30 s, and for PPM, 1-2 s.

This parameter should be similar (or identical) in whole CE interconnection. According to [36] fully reserve should be activated in 30 s (refer to existing units), therefore it is recommended to set maximum admissible full activation time on 30 seconds.

Considering typical responses of HPP unit and TPP unit, shown in Figure 22 and Figure 23, it could be noticed that HPP units respond slower in the first few seconds due to higher time constant of guide vanes but the process is completed within 30 seconds. The power generating modules connected to network via power electronics have much faster responses, thus they can fulfill this requirement.

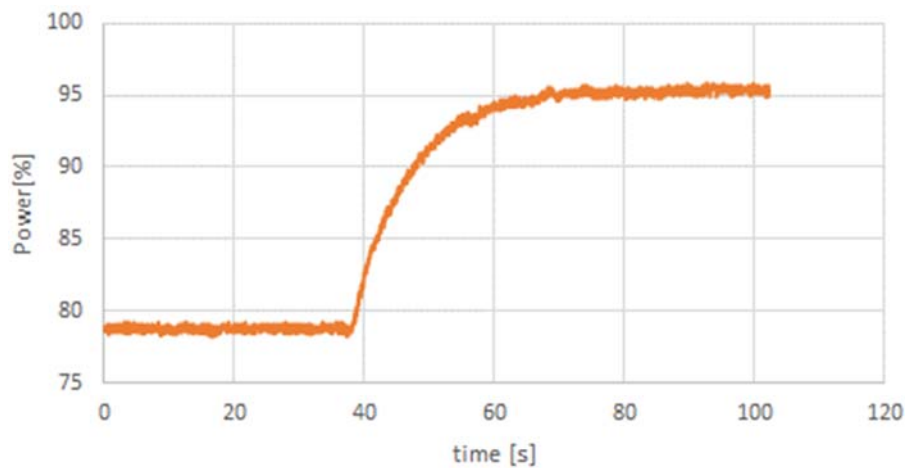

Figure 22 - FCR response of typical HPP

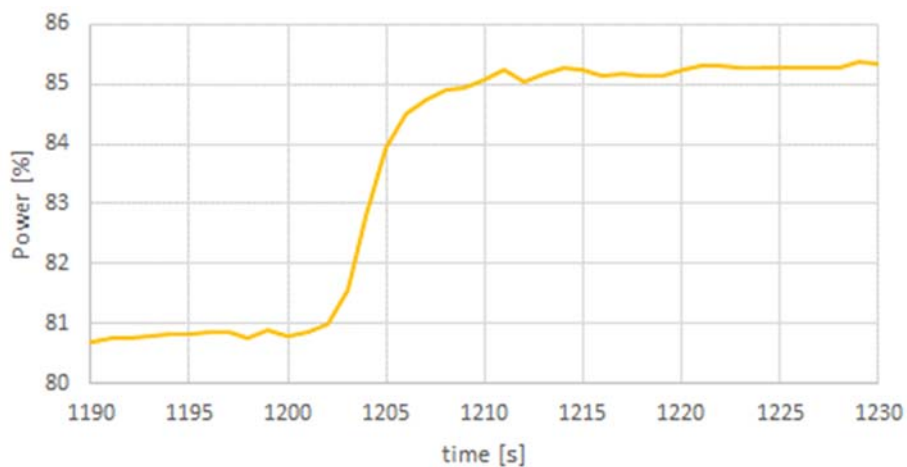

Figure 23 - FCR response of typical TPP

Non-exhaustive Requirement

Maximum admissible initial delay for PGMs without inertia

Articles 15(2)(d)(iv)

2) Type C power-generating modules shall fulfil the following requirements relating to frequency stability:

d) in addition to point (c) of paragraph 2, the following shall apply cumulatively when frequency sensitive mode ('FSM') is operating:

(iv) the initial activation of active power frequency response required shall not be unduly delayed. If the delay in initial activation of active power frequency response is greater than two seconds, the power-generating facility owner shall provide technical evidence demonstrating why a longer time is needed.

For power-generating modules without inertia, the relevant TSO may specify a shorter time than two seconds. If the power-generating facility owner cannot meet this requirement they shall provide technical evidence demonstrating why a longer time is needed for the initial activation of active power frequency response.

Applicability:

Type C and D PGMs

Non -Mandatory

General

ENTSO-E Practice

Maximum admissible initial delay for PGMs without inertia: 0.5 - 2 s

Power generating modules without inertia have controller with algorithms cycle time less than 10 ms. Therefore, 500 ms of initial delay should be enough for response of PGM without inertia. However, this parameter should be considered together with the requirement for synthetic inertia, i.e. only if synthetic inertia is not required, it makes sense to define this parameter.

Non-exhaustive Requirement	Time period for the provision of full active power frequency response
Articles 15(2)(d)(v)	<p>2) Type C power-generating modules shall fulfil the following requirements relating to frequency stability:</p> <p>d) in addition to point (c) of paragraph 2, the following shall apply cumulatively when frequency sensitive mode ('FSM') is operating:</p> <p>(v) the power-generating module shall be capable of providing full active power frequency response for a period of between 15 and 30 minutes as specified by the relevant TSO. In specifying the period, the TSO shall have regard to active power headroom and primary energy source of the power-generating module;</p>
Applicability:	Type C and D PGMs
Mandatory	
General	
ENTSO-E Practice	Time period for the provision of full active power frequency response: 15, 20 or 30 minutes

Considering primary energy source of power-generating modules providing frequency containment control, TSO could specify either 15 minutes or 30 minutes requirement for time period for provision of full active power frequency response.

A problem with primary energy source on one TPP unit is shown on Figure 24. It can be seen that not-sustainable response occurs after a few minutes. From the operational practice, it is proven that if the provision of full active power frequency response is stable and sustainable for 10 minutes, it will be also stable for 30 minutes.

In case of significant disturbances, such as system split, it is possible that frequency containment control is required for as long as possible, therefore it is recommended to set parameter time period for the provision of full active power frequency response on value of 30 minutes.

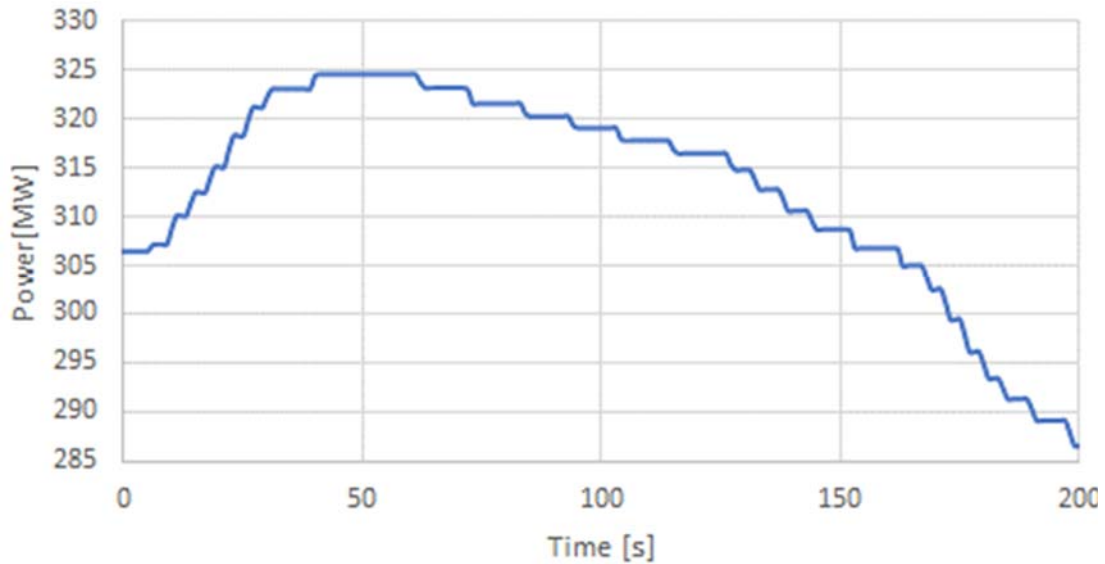

Figure 24 - Unstable FCR response on TPP

2.2.4. Limited Frequency Sensitivity Mode - Overfrequency

Non-exhaustive Requirement	Frequency threshold Droop settings
-----------------------------------	---------------------------------------

2. With regard to the limited frequency sensitive mode - overfrequency (LFSM-O), the following shall apply, as determined by the relevant TSO for its control area in coordination with the TSOs of the same synchronous area to ensure minimal impacts on neighbouring areas:

(a) the power-generating module shall be capable of activating the provision of active power frequency response according to figure 1 at a frequency threshold and droop settings specified by the relevant TSO;

Articles
13(2)(a)

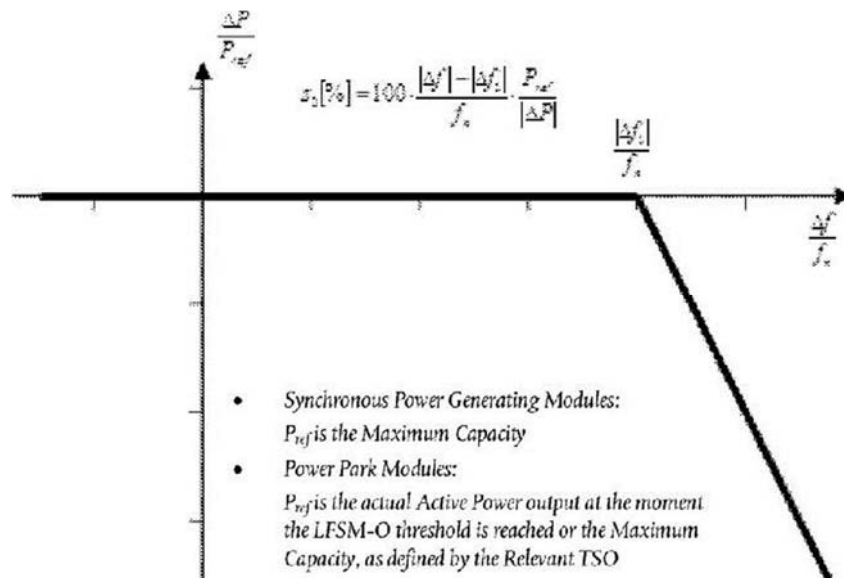

Figure 25 - LFSM-O characteristic

Applicability: Type A, B, C and D PGMs

Mandatory

General

ENTSO-E Practice	For CE interconnection, mostly Frequency threshold: 50.2 Hz Droop settings: 5%
-------------------------	--------------------------------------------------------------------------------------

According to NC RfG, the LFSM-O/-U droop is defined as

$$[\%]=100 \cdot \frac{\Delta f - \Delta f_1}{f_n} \cdot \frac{P_{ref}}{\Delta P}$$

P_{ref} is the reference active power,

ΔP is the change in active power output from the power-generating module,

f_n is the nominal frequency (50 Hz) in the network

Δf is the frequency deviation in the network

Δf_1 is the frequency threshold of the LFSM-O/-U. At overfrequencies/underfrequencies where Δf is above/below Δf_1 , the power generating module has to provide an active power output change according to the droop.

It is important to notice that LFSM-O service can be provided by every power generating module in operation above its minimum level.

According to [39], frequency-related network issues normally require a consistent response within the same synchronous area and therefore collaboration between TSOs of the same synchronous area is necessary.

Due to the system-wide effect of frequency-related issues, a harmonized setting of these parameters within a synchronous area is essential.

In order to best coordinate active power response by LFSM-O/-U with the provision of FCR, it is recommended to activate it at full deployment of FCR, i.e. to set the frequency threshold such, that there is no overlap or gap between FCR and LFSM-O/-U.

Considering statements above, LFSM-O should be extended FCR, and recommendation is to set parameters in the following manner:

- Frequency threshold: 50.2 Hz
- Droop settings: 4 % for area with dominantly hydro portfolio, and 5% in area where TPP exists (PGM without inertia can meet requirements for SPGM)

It should be emphasized that for proper functioning of LFSM function (both, over and under frequency) on HPP units it is essential to correctly set the algorithm for detecting of isolated operation.

Non-exhaustive Requirement	Use of automatic disconnection and reconnection
Articles 13(2)(b)	<p>2. With regard to the limited frequency sensitive mode - overfrequency (LFSM-O), the following shall apply, as determined by the relevant TSO for its control area in coordination with the TSOs of the same synchronous area to ensure minimal impacts on neighbouring areas:</p> <p>(b) instead of the capability referred to in paragraph (a), the relevant TSO may choose to allow within its control area automatic disconnection and reconnection of power-generating modules of Type A at randomised frequencies, ideally uniformly distributed, above a frequency threshold, as determined by the relevant TSO where it is able to demonstrate to the relevant regulatory authority, and with the cooperation of power-generating facility owners, that this has a limited cross-border impact and maintains the same level of operational security in all system states;</p>

Applicability: Type A

Non - Mandatory

General

ENTSO-E Practice Parameter is mostly defined like “allowed”, but without exact definition of frequency threshold.

If TSO decide to allow automatic disconnection and reconnection, frequency threshold shall be uniformly distributed. It is recommended that frequency threshold should be calculated for each type A PGM, by using the following equations:

- Disconnection: frequency threshold= $50.2 \text{ Hz} + \frac{P_{ref}}{P_{Amax}} \cdot 0.3 \text{ Hz}$
- Reconnection: when frequency is less than frequency threshold= $50.1 \text{ Hz} - \frac{P_{ref}}{P_{Amax}} \cdot 0.05 \text{ Hz}$, not less than 60 seconds

Pref - Unit rated power;

PAmax - Maximum power for type A.

Non-exhaustive Requirement Expected behaviour of the PGM once the regulating minimum level is reached

Articles 13(2)(f)

2. With regard to the limited frequency sensitive mode - overfrequency (LFSM-O), the following shall apply, as determined by the relevant TSO for its control area in coordination with the TSOs of the same synchronous area to ensure minimal impacts on neighbouring areas:

(f) the relevant TSO may require that upon reaching minimum regulating level, the power-generating module be capable of either:

(i) continuing operation at this level; or

(ii) further decreasing active power output;

Applicability: Type A, B, C and D PGMs

Non - Mandatory

General

ENTSO-E Practice TSO’s mostly choose option to continuing operation at minimum regulating level

The minimum regulating level represents limit for stable control of the unit. Therefore, it is recommended to prefer continued operation at minimum regulating level.

2.2.5. Limited Frequency Sensitivity Mode - Underfrequency

Non-exhaustive Requirement

- Frequency threshold
- Droop
- Definition of Pref

Type C power-generating modules shall fulfil the following requirements relating to frequency stability:

(c) In addition to Article 13(2), the following requirements shall apply to type C power-generating modules with regard to limited frequency sensitive mode - underfrequency (LFSM-U):

(i) the power-generating module shall be capable of activating the provision of active power frequency response at a frequency threshold and with a droop specified by the relevant TSO in coordination with the TSOs of the same synchronous area as follows:

- the frequency threshold specified by the TSO shall be between 49,8 Hz and 49,5 Hz inclusive,

- the droop settings specified by the TSO shall be in the range 2-12 %. This is represented graphically in Figure 4;

(ii) the actual delivery of active power frequency response in LFSM-U mode shall take into account:

- ambient conditions when the response is to be triggered,

- the operating conditions of the power-generating module, in particular limitations on operation near maximum capacity at low frequencies and the respective impact of ambient conditions according to paragraphs 4 and 5 of Article 13, and

- the availability of the primary energy sources.

(iii) the activation of active power frequency response by the power-generating module shall not be unduly delayed. In the event of any delay greater than two seconds, the power-generating facility owner shall justify it to the relevant TSO;

(iv) in LFSM-U mode the power-generating module shall be capable of providing a power increase up to its maximum capacity;

(v) stable operation of the power-generating module during LFSM-U operation shall be ensured;

Articles 15(2)(c)

- Synchronous Power Generating Modules:
 P_{ref} is the Maximum Capacity
- Power Park Modules:
 P_{ref} is the actual Active Power output at the moment the LFSM-U threshold is reached or the Maximum Capacity, as defined by the Relevant TSO

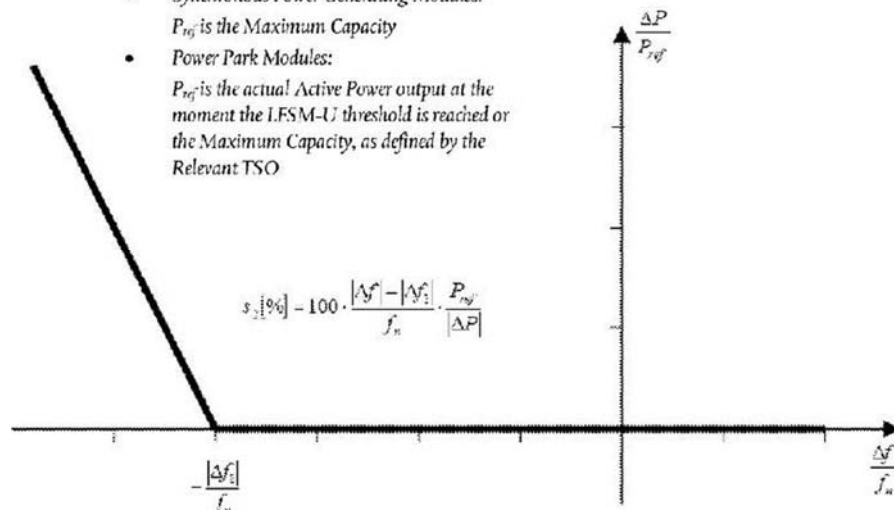

Figure 26 - LFSM-U characteristic

Applicability: Type C and D PGMs

Mandatory

General

**ENTSO-E
Practice** Frequency threshold: mostly 49.8
 Droop: mostly 5%
 Definition of Pref: mostly Pmax

Considering the explanation, given in subchapter 2.2.4, it is recommended to set parameters in the following manner:

- Frequency threshold: 49.8 Hz
- Droop settings: 4 % for area with dominantly hydro portfolio in the energy mix, and 5% for area where TPP exists (PGM without inertia can meet requirements for SPGM)
- Pref=Pmax due to easier planning of LFSM-U reserves

2.2.6. Admissible Active Power Reduction

Non-exhaustive Requirement Admissible active power reduction from max. output with falling frequency

4. The relevant TSO shall specify admissible active power reduction from maximum output with falling frequency in its control area as a rate of reduction falling within the boundaries, illustrated by the full lines in Figure 2:

(a) below 49 Hz falling by a reduction rate of 2 % of the maximum capacity at 50 Hz per 1 Hz frequency drop;

(b) below 49,5 Hz falling by a reduction rate of 10 % of the maximum capacity at 50 Hz per 1 Hz frequency drop.

Articles 13(4)

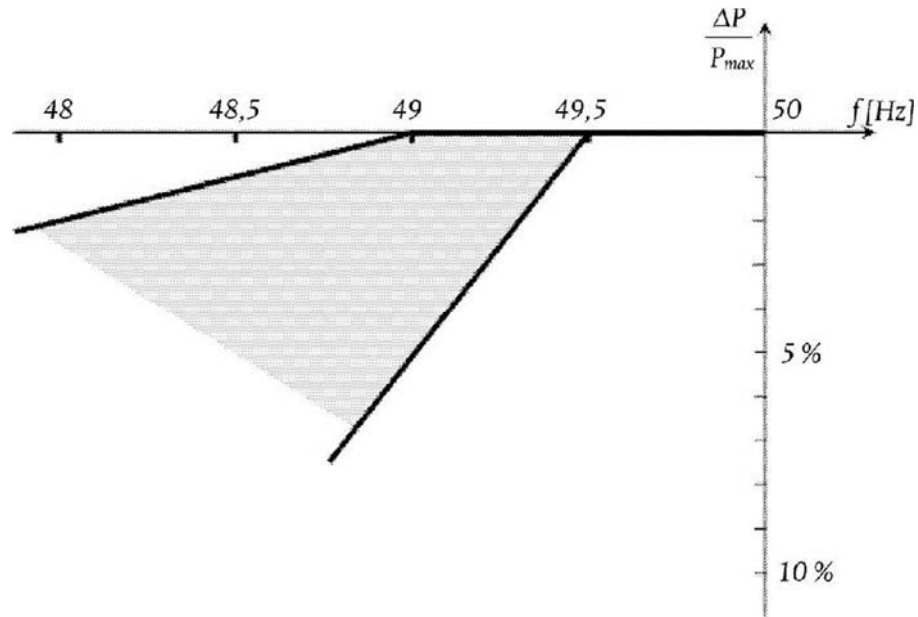

Figure 27 - Admissible active power reduction characteristic

Applicability: Type A, B, C and D PGMs

Mandatory

General

ENTSO-E Practice Different definitions are used.

According to [40], active power output of gas turbines is sensitive to lower level of system frequency. A gas turbine commonly operated in the power system include a shaft driven air compressor at the turbine inlet. Therefore, any disturbance in the system with decrease of system frequency will slow down the compressor. This results in a reduction of the mass flow of air through the turbine and reduction of the active power output of the CCGT. This effect is much stronger at high ambient temperatures, as it is shown on Figure below.

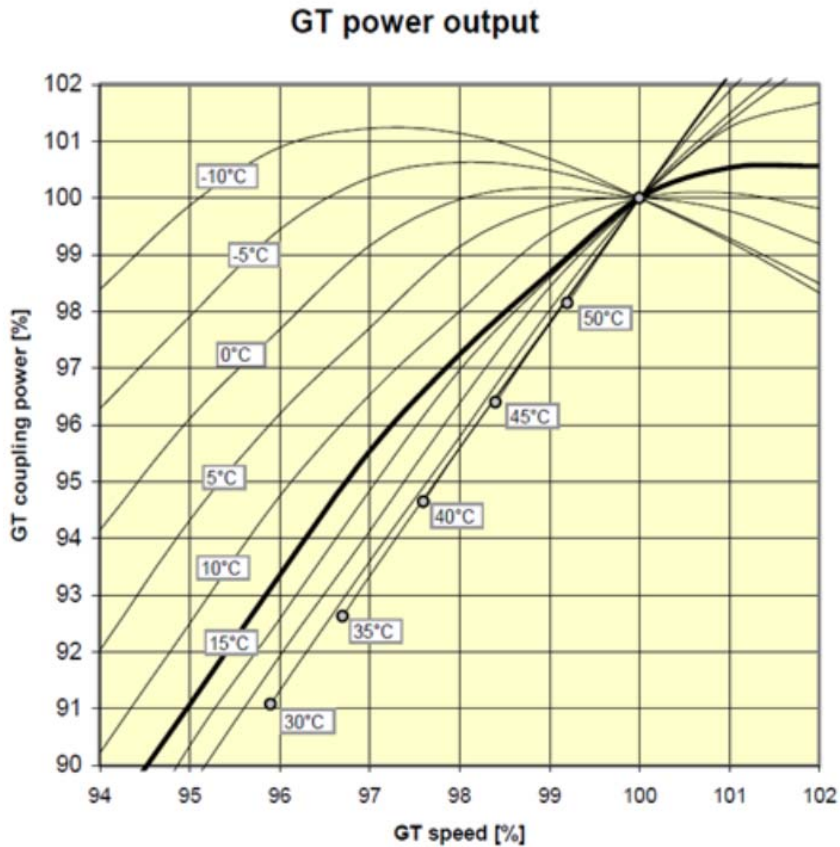

Figure 28 - Gas turbine power output

It should be noted that when the integration of RES is significant, the inertia and the controllability of the system is reduced, the importance of gas turbines for the system is more significant than the reduction of output power due to frequency decrease. Therefore, it is recommended to relax requirements for gas turbines as much as possible. A proposal for parameters:

- reduction 10 % of Pmax per Hz
- starting at 49,5 Hz.

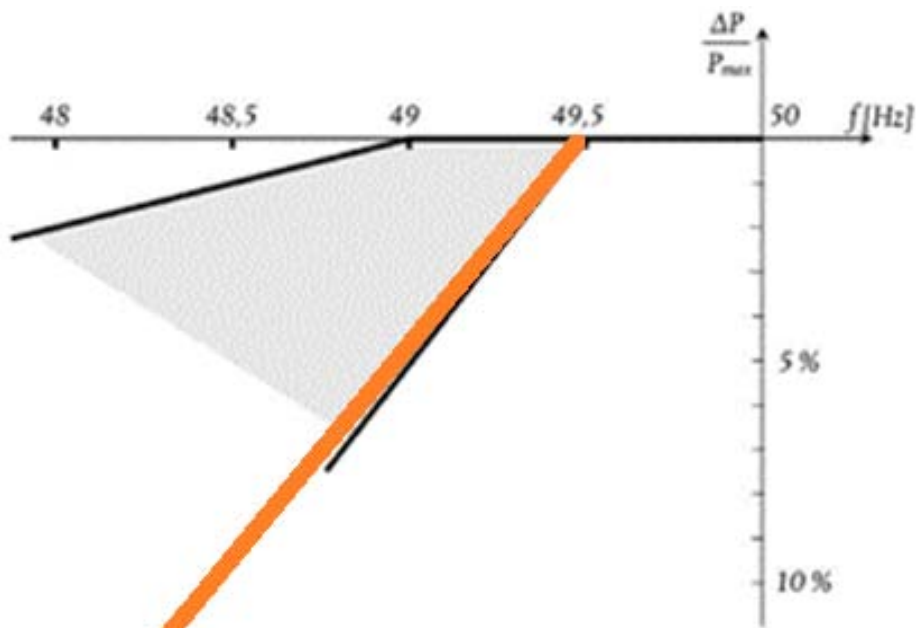

Figure 29 - Recommendation for parameter Admissible active power reduction from max. output with falling frequency

Non-exhaustive Requirement	Definition of the ambient conditions applicable when defining the admissible active power reduction and take into account of the capabilities of PGM
Articles 13(5)	<p>5. The admissible active power reduction from maximum output shall:</p> <p>(a) clearly specify the ambient conditions applicable;</p> <p>(b) take account of the technical capabilities of power-generating modules.</p>
Applicability:	Type A, B, C and D PGMs
Mandatory	
General	
ENTSO-E Practice	<p>temperature 10, 15, 25, 0°C,</p> <p>Humidity 60 %, 70 %, [15-20]Gh20/kG</p> <p>Altitude 350 -420, 400-500.</p>

According to international standard ISO2314:2009, the following ambient conditions are taken for gas turbine designing:

- Temperature - 15 Celsius degrees
- Humidity - 60%
- Air pressure - 1.013 bar

However, in order to anticipate eventual changes in active power, it is suggested to apply the following ambient conditions:

- average annual temperature,
- average annual humidity,
- average altitude of potential locations for gas turbines in the system.

2.2.7. Logic Interface and automatic connection to the network

Non-exhaustive Requirement	Requirements for the additional equipment necessary to allow active power output to be remotely operable
Articles 13(6)	<p>6. The power-generating module shall be equipped with a logic interface (input port) in order to cease active power output within five seconds following an instruction being received at the input port.</p> <p>The relevant system operator shall have the right to specify requirements for equipment to make this facility operable remotely.</p>
Applicability:	Type A and B
Non - Mandatory	
Site specific	
ENTSO-E Practice	<p>In most of countries, this requirement is not defined. Example of definition:</p> <ul style="list-style-type: none"> — If ≤500kW - radio ripple control receiver — If >500 KW - telecontrol, can switch transfer circuit breaker <p>Larger than 10 kW, shall have logic interface</p>

If the DSO has a SCADA system that allows the logical interface to be used to cease active power, the DSO needs to specify:

- power threshold to which the requirement applies
- type of telecommunication connection to PGM
- telecommunication interface
- list of signals from the PGM
- how to send a command to cease active power.

Non-exhaustive Requirement	Automatic Connection to the Network
Articles 13(7)	<p>7. The relevant TSO shall specify the conditions under which a power-generating module is capable of connecting automatically to the network. Those conditions shall include:</p> <p>(a) frequency ranges within which an automatic connection is admissible, and a corresponding delay time; and</p> <p>(b) maximum admissible gradient of increase in active power output.</p> <p>Automatic connection is allowed unless specified otherwise by the relevant system operator in coordination with the relevant TSO.</p>
Applicability:	Type A, B and C
Mandatory	
General	
ENTSO-E Practice	<p>Frequency ranges: $47.5 \text{ Hz} \leq f \leq 50.05 \text{ Hz}$, $49,9\text{Hz} < f < 50,1\text{Hz}$</p> <p>Voltage ranges: 0.9-1.1</p> <p>Corresponding delay time 0 - 900 s</p> <p>Maximum admissible gradient of increase in active power output: 10-100 Pmax/min, mostly 10-20 % Pmax/min</p>

In document [41], the principle for automatic reconnection after an incidental disconnection is as depicted on Figure below.

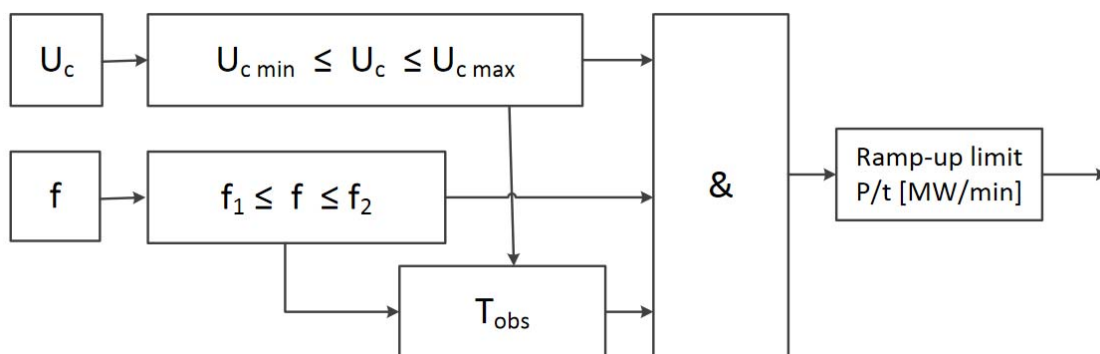

Figure 30 - Principle for automatic reconnection

In guidelines default values of parameters for reconnection are:

- Voltage range: $0.9 \text{ pu} \leq U \leq 1.1 \text{ pu}$; and
- Frequency range: $49.9 \text{ Hz} \leq f \leq 50.1 \text{ Hz}$
- Minimum observation time: 60 s;
- Maximum gradient of active power increase $\leq 20\%$ of Pmax/min

It is recommended to revise these parameters in the following way:

- Upper limit should be set to 50.05 Hz
- Minimum observation time should be uniformly distributed. It is recommended to calculate minimum observation by using the following equation:
- $T_{obs} = 30 s + \frac{P_{ref}}{P_{Cmax}} \cdot 300 s$
 P_{ref} - Unit rated power;
 P_{Cmax} - Maximum power for type C.

Voltage range and Maximum gradient of active power increase should be as it is proposed in the guidelines.

Non-exhaustive Requirement	Logic Interface (2)
Articles 14(2)(b)	<p>2. Type B power-generating modules shall fulfil the following requirements in relation to frequency stability:</p> <p>(b) the relevant system operator shall have the right to specify the requirements for further equipment to allow active power output to be remotely operated.</p>
Applicability:	Type B
Non - Mandatory	
Site specific	
ENTSO-E Practice	<p>Mostly this requirement is not defined. One definition:</p> <p>Above 1MW specified in time for new plant design</p>

If the DSO has a SCADA system that allow possibilities that active power output to be remotely operated, the DSO needs to specify:

- - power threshold to which the requirement applies (if it is not general for type B)
- - type of telecommunication connection to PGM
- - telecommunication interface
- - list of signals from the PGM
- - the manner in which the active power is set (impulses or setpoint).

2.2.8. Frequency Stability

Non-exhaustive Requirement	<p>Time period to reach the adjusted active power set point</p> <p>Tolerance applying to the new set point</p> <p>Time period to reach tolerance applying to the new set point</p>
Articles 15(2)(a)	<p>2. Type C power-generating modules shall fulfil the following requirements relating to frequency stability:</p> <p>(a) with regard to active power controllability and control range, the power-generating module control system shall be capable of adjusting an active power setpoint in line with instructions given to the power-generating facility owner by the relevant system operator or the relevant TSO. The relevant system operator or the relevant TSO shall establish the period within which the adjusted active power setpoint must be reached. The relevant TSO shall specify a tolerance (subject to the availability of the prime mover resource) applying to the new setpoint and the time within which it must be reached;</p>

Applicability: Type C and D

Mandatory

General

ENTSO-E Practice Defined periods and ramps are very different, from 10 s to 15 min, and 1% / min to 40% /min

Considering that TSO usually has approx. 20 minutes to apply remedial action after triggering of first step of overload protection and reduce line overload, it is recommended that 15 minutes interval should be defined as the longest period of time for PGM to reach a new setpoint value.

Tolerance applying to the new setpoint should be less than 1% Pmax.

2.2.9. Frequency Restoration Control

Non-exhaustive Requirement Specifications of the frequency restoration control

Articles 15(2)(e) *2. Type C power-generating modules shall fulfil the following requirements relating to frequency stability:
(e)with regard to frequency restoration control, the power-generating module shall provide functionalities complying with specifications specified by the relevant TSO, aiming at restoring frequency to its nominal value or maintaining power exchange flows between control areas at their scheduled values;*

Applicability: Type C and D

Mandatory

General

ENTSO-E Practice Mostly parameter is not defined. Some of definitions:

- power change range: 40-60%Pn, gradient:4%Pn/min
- 10 seconds response time plus ramp rate of the unit. 3 minutes for wind turbine
- from 10% of the min. techn. capacity and agreed connection capacity the secondary frequency control is specified in FR with 4,5%Pmax of reserve.

SOGL, article 158 (1), defines FRR technical requirements:

- a FRR providing unit or FRR providing group for automatic FRR shall have an automatic FRR activation delay not exceeding 30 seconds;
- a FRR provider shall ensure that the FRR activation of the FRR providing units within a reserve providing group can be monitored. For that purpose, the FRR provider shall be capable of supplying to the reserve connecting TSO and the reserve instructing TSO real-time measurements of the connection point or another point of interaction agreed with the reserve connecting TSO concerning:
 - time-stamped scheduled active power output;
 - time-stamped instantaneous active power for:
 - each FRR providing unit,
 - each FRR providing group, and
 - each power generating module or demand unit of a FRR providing group with a maximum active power output larger than or equal to 1,5 MW;

According to UCTE document [36], the rate of change in the power output of generators used for SECONDARY CONTROL must be sufficient for SECONDARY CONTROL purposes. The rate of change is

defined as a percentage of the rated output of the controlled generator per unit of time, and strongly depends upon the type of generator. Typically, for oil- or gas-fired power stations, this rate is of the order of 8% per minute. In the case of reservoir power stations, the rate of continuous power change ranges from 1.5 to 2.5% of the rated plant output per second (90 %/minute). For hard coal and lignite-fired plants, this rate ranges from 2 to 4% per minute and 1 to 2% per minute respectively. The maximum rate of change in output of nuclear power plants is approximately 1 to 5% per minute.

These sample figures for customary rates of change in SECONDARY CONTROL action will be used as an aid to the definition of an optimum offset correction time. TSO should define minimal rate of change in the power output. The following is recommended:

- Gas-fired TPP - 8%Pmax/minute
- Coal-fired TPP - 2%Pmax/minute
- Nuclear TPP - 1%Pmax/minute
- Other PGMs - 20%Pmax/minute

2.2.10. Real-Time Monitoring of FSM

Non-exhaustive Requirement	List of the necessary data which will be sent in real time Definition of additional signals
Articles 15(2)(g)	<p><i>(g)with regard to real-time monitoring of FSM:</i></p> <p><i>(i)to monitor the operation of active power frequency response, the communication interface shall be equipped to transfer in real time and in a secured manner from the power-generating facility to the network control centre of the relevant system operator or the relevant TSO, at the request of the relevant system operator or the relevant TSO, at least the following signals:</i></p> <ul style="list-style-type: none"> - status signal of FSM (on/off), - scheduled active power output, - actual value of the active power output, - actual parameter settings for active power frequency response, - droop and deadband; <p><i>(ii)the relevant system operator and the relevant TSO shall specify additional signals to be provided by the power-generating facility by monitoring and recording devices in order to verify the performance of the active power frequency response provision of participating power-generating modules.</i></p>
Applicability:	Type C and D
Mandatory	
Site Specific	
	In most of the cases, list of additional signals is not defined. An example of list of signals:
ENTSO-E Practice	<ul style="list-style-type: none"> — U, P, Q and status of main breakers leading to generator — a list of data are defined, for example: U, P, Q and status of main breakers leading to generator — FSM status, scheduled/actual active power value, actual frequency response settings, droop/deadband;

Other parameters that are important for FSM response:

- Limits of active power,
- Control mode of PGM,

- Command for activation of FSM (ON/OFF),
- Command for simulation testing of FSM.

2.2.11. Rates of Change of Active Power Output

Non-exhaustive Requirement	Taking into consideration the specific characteristics of the prime mover technology: Minimum limit of change of active power output in down direction Maximum limit of change of active power output in down direction Minimum limit of change of active power output in up direction Maximum limit of change of active power output in up direction
Articles 15(6)(e)	<i>(e)the relevant system operator shall specify, in coordination with the relevant TSO, minimum and maximum limits on rates of change of active power output (ramping limits) in both an up and down direction of change of active power output for a power-generating module, taking into consideration the specific characteristics of prime mover technology;</i>
Applicability:	Type C and D
Mandatory	
General	
ENTSO-E Practice	change of active power output: in range 1 - 40 %Pmax/min

Considering automatic connection to the network requirements and frequency restoration control requirements, minimum rate of change of active power output in both directions is 1% Pmax/minute (rate of change of active power output for nuclear and coal fired thermal power plants) and maximal rate of change of active power output can be even higher than 100%Pmax/minute⁷.

The fastest change in active power needs to be triggered by frequency containment control. The rate of change of FCR was defined with define ranges for reserve and time for response, 10% Pmax in 30 seconds, convert to %Pmax/minute it is 20%Pmax/minute, and that is maximal rate of change of active power output that shall be required from PGM's.

Considering the abovementioned, the following parameters are recommended:

- Minimum limit of change of active power output in down direction: 1%Pmax/minute
- Maximum limit of change of active power output in down direction: 20%Pmax/minute
- Minimum limit of change of active power output in up direction: 1%Pmax/minute
- Maximum limit of change of active power output in up direction: 20 %Pmax/minute

⁷ The rate of change of active power output on run-of-river hydro units from 0% to 100% is less than 60 seconds

2.3. Voltage Issues

2.3.1. Voltage Ranges

Non-exhaustive Requirement	<p>Time period for operation within voltage range at connection point 1.118 pu - 1.15 pu</p> <p>Time period for operation within voltage range at connection point 1.05pu-1.10pu</p> <p>Shorter time period in the event of simultaneous overvoltage/undervoltage and underfrequency/overfrequency</p>
Articles 16.2(a):	<p><i>“Type D power-generating modules shall fulfil the following requirements relating to voltage stability:</i></p> <p><i>(a) with regard to voltage ranges:</i></p> <p><i>(i) without prejudice to point (a) of Article 14(3) and point (a) of paragraph 3 below, a power-generating module shall be capable of staying connected to the network and operating within the ranges of the network voltage at the connection point, expressed by the voltage at the connection point related to the reference 1 pu voltage, and for the time periods specified in Tables 6.1 and 6.2;</i></p> <p><i>(ii) the relevant TSO may specify shorter periods of time during which power-generating modules shall be capable of remaining connected to the network in the event of simultaneous overvoltage and underfrequency or simultaneous undervoltage and overfrequency;</i></p> <p><i>(iii) notwithstanding the provisions of point (i), the relevant TSO in Spain may require power-generating modules to be capable of remaining connected to the network in the voltage range between 1,05 pu and 1,0875 pu for an unlimited period;</i></p> <p><i>(iv) for the 400 kV grid voltage level (or alternatively commonly referred to as 380 kV level), the reference 1 pu value is 400 kV; for other grid voltage levels, the reference 1 pu voltage may differ for each system operator in the same synchronous area;</i></p> <p><i>(v) notwithstanding the provisions of point (i), the relevant TSOs in the Baltic synchronous area may require power-generating modules to remain connected to the 400 kV network in the voltage range limits and for the time periods that apply in the Continental Europe synchronous area;”</i></p>
Applicability:	Type D PGMs
Mandatory/Non-Mandatory 16.2(a)(ii)	
Dependencies:	Frequency ranges
ENTSO-E Practice	<ul style="list-style-type: none"> • 60 minutes (roughly 50% of countries, e.g. CZ, DK, ES, CR, SL, SK, etc.) • 20 minutes (roughly 30% of countries, e.g. BE, FR, RO, etc.) • 30 minutes (roughly 20% of countries, e.g. AT, DE, LU)
For shorter time periods (i.e. Article 16.2(a)(ii)) different definitions are used	

Non-exhaustive Requirement	Wider voltage ranges
Articles 16.2(b):	<i>“(b) wider voltage ranges or longer minimum time periods for operation may be agreed between the relevant system operator and the power-generating facility owner in coordination with the relevant TSO. If wider voltage ranges or longer minimum times for operation are economically and technically feasible, the power-generating facility owner shall not unreasonably withhold an agreement;”</i>
Applicability:	Type D PGMs
Non-mandatory	
Site specific	
ENTSO-E Practice	Defined as site specific requirement

Tables referenced in this requirement, i.e. RfG Table 6.1 and 6.2, are given here as Table 7 and Table 8.

Table 7 - Minimum time periods during which a PGM must be capable of operating without disconnecting from the network, for grid of nominal voltage level from 110 kV to 300 kV

Synchronous area	Voltage range	Time period for operation
Continental Europe	0.85 pu - 0.9 pu ⁸	60 minutes
	0.9 pu - 1.118 pu	Unlimited
	1.118 pu - 1.15 pu	To be specified by each TSO, but not less than 20 minutes and not more than 60 minutes
Georgia	0.85 pu - 0.9 pu	60 minutes
	0.9 pu - 1.12 pu	Unlimited
	1.12 pu - 1.15 pu	20 minutes

Table 8 - Minimum time periods during which a PGM must be capable of operating without disconnecting from the network, for grid of nominal voltage level from 300 kV to 500 kV

Synchronous area	Voltage range	Time period for operation
Continental Europe	0.85 pu - 0.9 pu	60 minutes
	0.9 pu - 1.05 pu	Unlimited
	1.05 pu - 1.1 pu	To be specified by each TSO, but not less than 20 minutes and not more than 60 minutes
Georgia	0.85 pu - 0.9 pu	60 minutes
	0.9 pu - 1.1 pu	Unlimited
	1.1 pu - 1.15 pu	20 minutes

⁸ Note that 1 pu corresponds to nominal voltage level of the grid, except in the case of 380 kV and 400 kV nominal voltage levels where 1 pu corresponds to the value of 400 kV.

From the values given in Table 7 and Table 8 it is clear that the only non-exhaustive requirement that needs to be defined is time period for operation in the case of highest voltages. The requested time period must be between lower and upper limit of 20 minutes and 60 minutes, respectively. When defining this requirement compromise is needed between time needed to TSO in order to perform adequate actions to bring back the voltages in normal operating ranges and the time period that user's equipment is under high voltages. Having in mind that EnC countries at the moment do not employ automatic secondary voltage control, the recommendation regarding this parameter is to request from user's equipment to be capable to operate with high voltages up to the upper permissible limit of 60 minutes. It should be kept in mind that highest permissible voltages create additional strain to the equipment insulation, which can lead to reduction of equipment's expected lifetime. This effect is cumulative, both duration of high voltage at a time, and cumulative operation under high voltages for example over a period of one year, can have negative effect on equipment lifetime. However this should be regulated in system operations part of national grid code. System operators (TSOs and DSOs) are obligated to control reactive power in the system in a way that will allow voltages to be within pre-described values. Adequate procedures should be put in place in order to avoid having excessive voltage levels, and to limit the duration of these high voltage operating regimes if they occur. If necessary system operators should consider additional actions, such as installment of reactive power compensation facilities.

Requirement for shorter periods of time during which power-generating modules shall be capable of remaining connected to the network in the event of simultaneous overvoltage and underfrequency or simultaneous undervoltage and overfrequency, is not mandatory. If TSOs decide to implement this requirement they should keep in mind the maximum possibilities of the power generating facility equipment. Such considerations could be found in international and/or national standards for generating unit's equipment. For example, requirements for synchronous generators' capability to operate during simultaneous overvoltage-underfrequency and undervoltage-overfrequency are given in IEC 60034-1 and IEC 60034-3. IEC 60034-1 standard defines two zones of operation for AC machines in the case of voltage and frequency deviations: Zone A and Zone B. For the Zone A the standard states that *"a machine shall be capable of performing its primary function, ..., continuously within zone A, but need not comply fully with its performance at rated voltage and frequency (...) and may exhibit some deviations. Temperature rises may be higher than at rated voltage and frequency"*. For Zone B the standard states that *"a machine shall be capable of performing its primary function within zone B, but may exhibit greater deviations from its performance at rated voltage and frequency than in zone A. Temperature rises may be higher than at rated voltage and frequency and most likely will be higher than those in zone A. Extended operation at the perimeter of zone B is not recommended"*. More rigorous requirements are presented in IEC 60034-3, which is applicable to three-phase synchronous generators, having rated outputs of 10 MVA and above driven by steam turbines or combustion gas turbines. These machines are required to operate unlimited for voltage ranges of $\pm 5\%$ and frequency ranges of $\pm 2\%$, at machine terminals as given in Figure 32. Regarding operation outside shaded area given in Figure 32 standard defines that in order *"to minimize the reduction of the generator's lifetime due to the effects of temperature or temperature differences, operation outside the shaded area should be limited in extent, duration and frequency of occurrence. The output should be reduced or other corrective measures taken as soon as practicable"*.

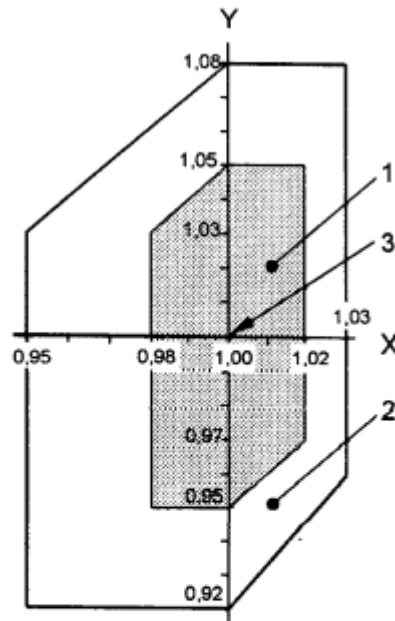

Key
 X axis frequency p.u.
 Y axis voltage p.u.

1 zone A
 2 zone B (outside zone A)
 3 rating point

Figure 31 - Voltage and frequency limits for AC generators according to IEC 60034-1 standard

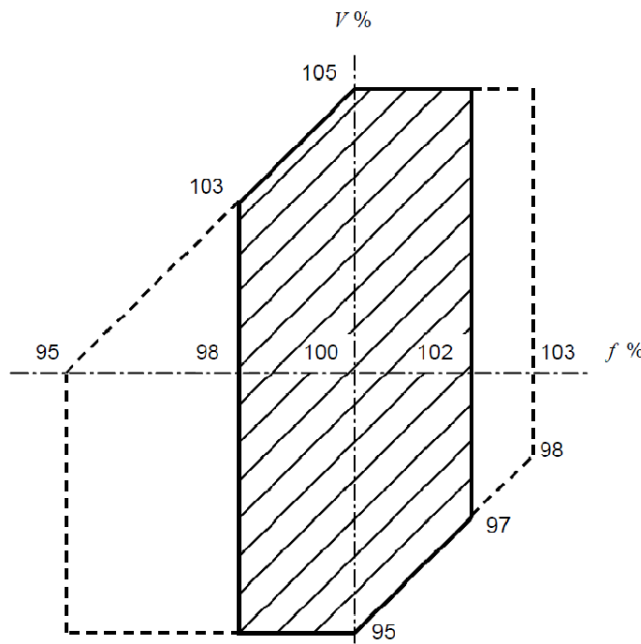

Figure 32 - Voltage and frequency limits for steam or gas turbine driven SPGMs with rated output at or above 10 MVA according to IEC 60034-1 standard

On the other hand, requirements applicable to power transformers regarding operation at higher than rated voltage and/or other than rated frequency can be found in IEC 60076-1. As described in section

5.4.3 of the standard “a transformer shall be capable of continuous operation at rated power without damage under conditions of 'overfluxing' where the value of voltage divided by frequency (V/Hz) exceeds the corresponding value at rated voltage and rated frequency by no more than 5 %, unless otherwise specified by the purchaser”. At no-load conditions standard defines that permissible overfluxing is 110%. This is in accordance with limiting overflux conditions defined for steam or gas driven synchronous generators presented in Figure 32 (slope of the line in the second quadrant). For loading between no-load and rated permissible overfluxing is given in standard as linear relationship

$$\frac{U}{U_r} \frac{f_r}{f} \leq 110 - 5K (\%)$$

where index r stands for rated values, and $0 < K < 1$ is ratio of current loading to rated loading. Standard explicitly states that if the transformer should be capable to be operated at V/Hz values higher than above stated values than “this shall be identified by the purchaser in the enquiry”. This request will have impact on equipment price.

Having in mind all previously stated, requirement for wider voltage ranges or longer minimum time periods for operation, should be assessed according to economical and technical impact that the request will have, i.e. cost-benefit analysis should be performed. Having in mind that the majority of the EnC countries are facing high voltage problems this analysis could be beneficial. However even if applied, this requirement would apply only to the new facilities. Even if the CB analysis is not performed, and the requirement is not implemented in the grid code, it is strongly recommended to TSOs to inform future PGFO about possible high voltage issues, so that the future PGFO could opt for equipment with higher voltage ratings, having in mind expected operation under high voltage conditions during longer time periods, which will introduce more stress to the equipment and will have negative effects on the equipment’s expected lifetime.

2.3.2. Fault ride through capability

Non-exhaustive Requirement	<p>Required FRT profile for symmetrical and asymmetrical faults: Uret, Uclear,Urec1,Urec2, tclear, trec1, trec2, trec3</p> <p>Pre- and post-fault conditions</p>
Articles 14.3:	<p><i>“(a) with regard to fault-ride-through capability of power-generating modules:</i></p> <p><i>(i) each TSO shall specify a voltage-against-time-profile in line with Figure 3 at the connection point for fault conditions, which describes the conditions in which the power-generating module is capable of staying connected to the network and continuing to operate stably after the power system has been disturbed by secured faults on the transmission system;</i></p> <p><i>(ii) the voltage-against-time-profile shall express a lower limit of the actual course of the phase-to-phase voltages on the network voltage level at the connection point during a symmetrical fault, as a function of time before, during and after the fault;</i></p> <p><i>(iii) the lower limit referred to in point (ii) shall be specified by the relevant TSO using the parameters set out in Figure 3, and within the ranges set out in Tables 3.1 and 3.2;</i></p> <p><i>(iv) each TSO shall specify and make publicly available the pre-fault and post-fault conditions for the fault-ridethrough capability in terms of:</i></p> <ul style="list-style-type: none"> <i>• the calculation of the pre-fault minimum short circuit capacity at the connection point,</i> <i>• pre-fault active and reactive power operating point of the power-generating module at the connection point and voltage at the connection point, and</i> <i>• calculation of the post-fault minimum short circuit capacity at the connection point;</i> <p><i>(v) at the request of a power-generating facility owner, the relevant system operator shall provide the pre-fault and post-fault conditions to be considered for fault-ride-through capability as an outcome of the calculations at the connection point as specified in point (iv) regarding:</i></p> <ul style="list-style-type: none"> <i>• pre-fault minimum short circuit capacity at each connection point expressed in MVA,</i> <i>• pre-fault operating point of the power-generating module expressed in active power output and reactive</i> <i>• power output at the connection point and voltage at the connection point, and</i> <i>• post-fault minimum short circuit capacity at each connection point expressed in MVA.</i> <p><i>Alternatively, the relevant system operator may provide generic values derived from typical cases;</i></p> <p><i>(vi) the power-generating module shall be capable of remaining connected to the network and continuing to operate stably when the actual course of the phase-to-phase voltages on the network voltage level at the connection point during a symmetrical fault, given the pre-fault and post-fault conditions in points (iv) and (v) of paragraph 3(a), remain above the lower limit specified in point (ii) of paragraph 3(a), unless the protection scheme for internal electrical faults requires the disconnection of the power-generating module from the</i></p>

network. The protection schemes and settings for internal electrical faults must not jeopardise fault-ride-through performance;

(vii) without prejudice to point (vi) of paragraph 3(a), undervoltage protection (either fault-ride-through capability or minimum voltage specified at the connection point voltage) shall be set by the power-generating facility owner according to the widest possible technical capability of the power-generating module, unless the relevant system operator requires narrower settings in accordance with point (b) of paragraph 5. The settings shall be justified by the power-generating facility owner in accordance with this principle;

(b) fault-ride-through capabilities in case of asymmetrical faults shall be specified by each TSO.”

Applicability: Type B, C, D PGMs connected below 110 kV

Mandatory

Dependencies: **Determination of significance**

ENTSO-E Practice Different requirements for FRT profile are used. For more information [Appendix 3](#). FRT requirement for asymmetrical faults is mainly the same as for the symmetrical faults.

Pre- and post-fault conditions are mainly treated as site specific

Non-exhaustive Requirement Required FRT profile for symmetrical and asymmetrical faults:
Uret, Uclear, Urec1, Urec2, tclear, trec1, trec2, trec3
Pre- and post-fault conditions

Articles 16.3: “(a) with regard to fault-ride-through capability:

(i) power-generating modules shall be capable of staying connected to the network and continuing to operate stably after the power system has been disturbed by secured faults. That capability shall be in accordance with a voltage-against-time profile at the connection point for fault conditions specified by the relevant TSO.

The voltage-against-time-profile shall express a lower limit of the actual course of the phase-to-phase voltages on the network voltage level at the connection point during a symmetrical fault, as a function of time before, during and after the fault.

That lower limit shall be specified by the relevant TSO, using the parameters set out in Figure 3 and within the ranges set out in Tables 7.1 and 7.2 for type D power-generating modules connected at or above the 110 kV level.

That lower limit shall also be specified by the relevant TSO, using parameters set out in Figure 3 and within the ranges set out in Tables 3.1 and 3.2 for type D power-generating modules connected below the 110 kV level;

(ii) each TSO shall specify the pre-fault and post-fault conditions for the fault-ride-through capability referred to in point (iv) of Article 14(3)(a). The specified pre-fault and post-fault conditions for the fault-ride-through capability shall be made publicly available;

b) at the request of a power-generating facility owner, the relevant system operator shall provide the pre-fault and postfault conditions to be considered for

fault-ride-through capability as an outcome of the calculations at the connection point as specified in point (iv) of Article 14(3)(a) regarding:

(i) pre-fault minimum short circuit capacity at each connection point expressed in MVA;

(ii) pre-fault operating point of the power-generating module expressed as active power output and reactive power output at the connection point and voltage at the connection point; and

(iii) post-fault minimum short circuit capacity at each connection point expressed in MVA;

(c) fault-ride-through capabilities in case of asymmetrical faults shall be specified by each TSO.”

Applicability: Type D PGMs

Mandatory

Dependencies: **Determination of significance**

ENTSO-E Practice Different requirements for FRT profile are used. For more information [Appendix 3](#). FRT requirement for asymmetrical faults is mainly the same as for the symmetrical faults.

Pre- and post-fault conditions are mainly treated as site specific

FRT requirement is given in a form of voltage against time profile at connection point as presented in RfG Figure 3, here given in Figure 33. Parameters of FRT curve applicable to type B and C SPGM are given in RfG Table 3.1 and parameters applicable to type B and C PPMs are given in Table 7.2. Parameters of FRT curve applicable to type D SPGMs are given in Table 7.1 and for type D PPMs in Table 7.2 of RfG. Values of these parameters are summarized here in Table 9 and Table 10.

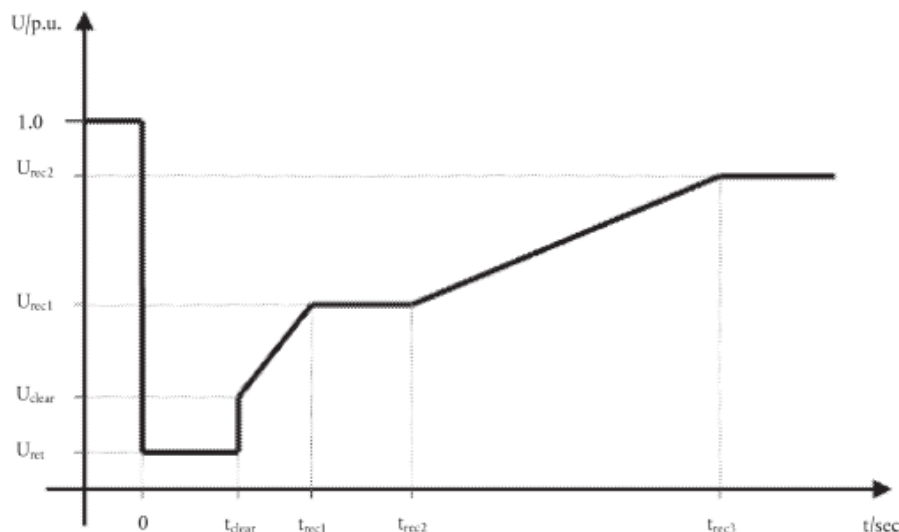

Figure 33 - Generic FRT voltage-against time profile ([1]Figure 3)

Table 9 - FRT parameters applicable to type B and C and D (<110 kV) PGMs

Type B, C and D (<110 kV) SPGMs				Type B, C and D (<110 kV) PPMs			
Voltage parameters (pu)		Time parameters (s)		Voltage parameters (pu)		Time parameters (s)	
U_{ret} :	0.05-0.3	t_{clear} :	0.14-0.15 (or 0.14-0.25)	U_{ret} :	0.05-0.15	t_{clear} :	0.14-0.15 (or 0.14-0.25)
U_{clear} :	0.7-0.9	t_{rec1} :	t_{clear}	U_{clear} :	$U_{ret} - 0.15$	t_{rec1} :	t_{clear}
U_{rec1} :	U_{clear}	t_{rec2} :	$t_{rec1} - 0.7$	U_{rec1} :	U_{clear}	t_{rec2} :	t_{rec1}
U_{rec2} :	0.85-0.9 & $\geq U_{clear}$	t_{rec3} :	$t_{rec2} - 1.5$	U_{rec2} :	0.85	t_{rec3} :	1.5-3

Table 10 - FRT parameters applicable to type D (>110 kV) PGMs

Type D (>110 kV) SPGMs				Type D (>110 kV) PPMs			
Voltage parameters (pu)		Time parameters (s)		Voltage parameters (pu)		Time parameters (s)	
U_{ret} :	0	t_{clear} :	0.14-0.15 (or 0.14-0.25)	U_{ret} :	0	t_{clear} :	0.14-0.15 (or 0.14-0.25)
U_{clear} :	0.25	t_{rec1} :	$t_{clear} - 0.45$	U_{clear} :	U_{ret}	t_{rec1} :	t_{clear}
U_{rec1} :	0.5-0.7	t_{rec2} :	$t_{rec1} - 0.7$	U_{rec1} :	U_{clear}	t_{rec2} :	t_{rec1}
U_{rec2} :	0.85-0.9	t_{rec3} :	$t_{rec2} - 1.5$	U_{rec2} :	0.85	t_{rec3} :	1.5-3

Longer time period values for parameter t_{clear} are applicable only in case when system protection and secure operation require so, as can be the case for DS connected PGMs. The requirement defined in Figure 33 is related to symmetrical faults, and voltage represented in figure is value of line to line voltage expressed in per unit of nominal value. Power generating module is expected to stay connected to the network if during system secured faults, time profile of voltage at module's connection point is above the line given in Figure 33, otherwise it is permitted to be disconnected from the network. In other words for each module calculated critical fault clearing time (t_{cfc}) characteristics should be greater than t_{clear} (i.e. $t_{cfc} > t_{clear}$).

Maximum and minimum requirements for type B, C and D SPGMs connected below 110 kV voltage level are given in Figure 34 and for type B, C and D PPMs connected below 110 kV voltage level in Figure 39. The requirement set by TSO should be between two lines given in these figures.

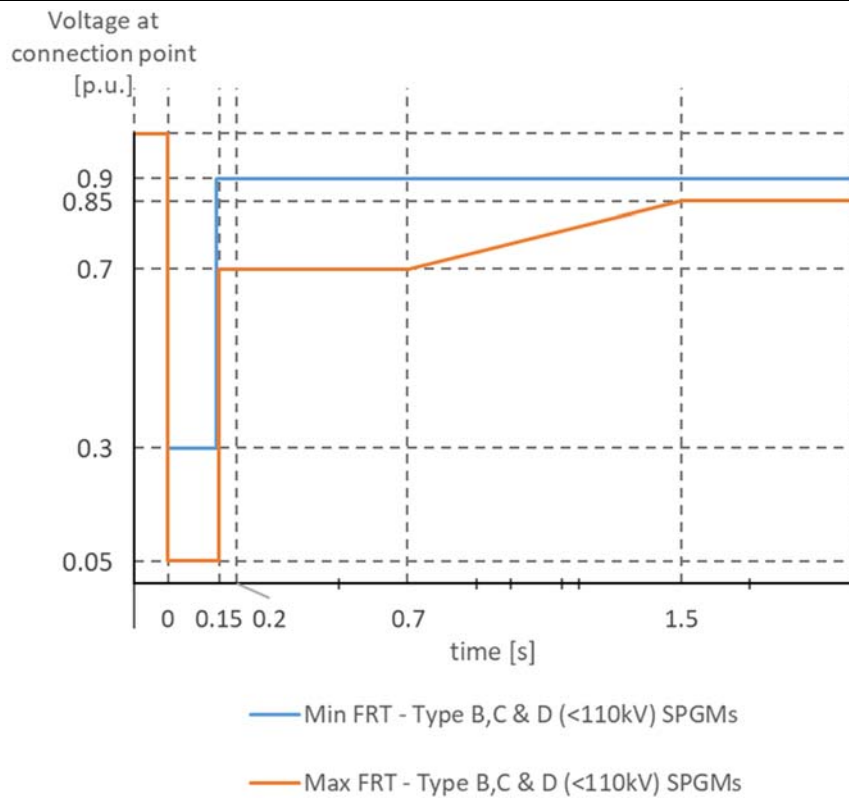

Figure 34 - Min and max possible FRT requirement for type B, C and D SPGMs connected below 110kV

Maximum and minimum requirements for type D SPGMs connected above 110 kV voltage level are given in Figure 35, and for type D PPMs connected above 110 kV voltage level in Figure 36. The requirement set by TSO should be between two lines given in these figures.

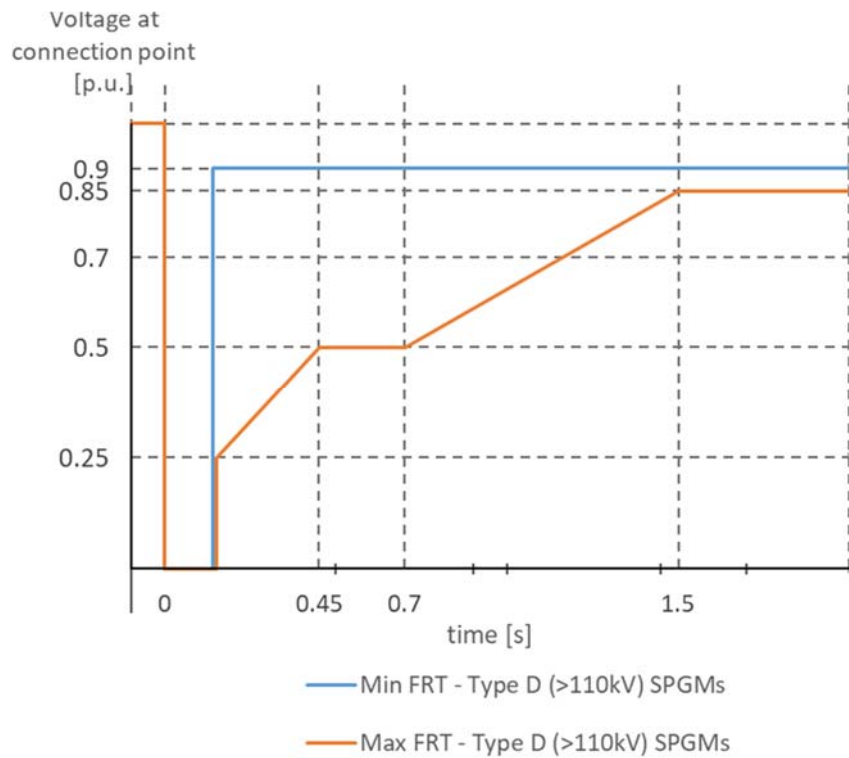

Figure 35 - Min and max possible FRT requirement for type D SPGMs connected at or above 110kV

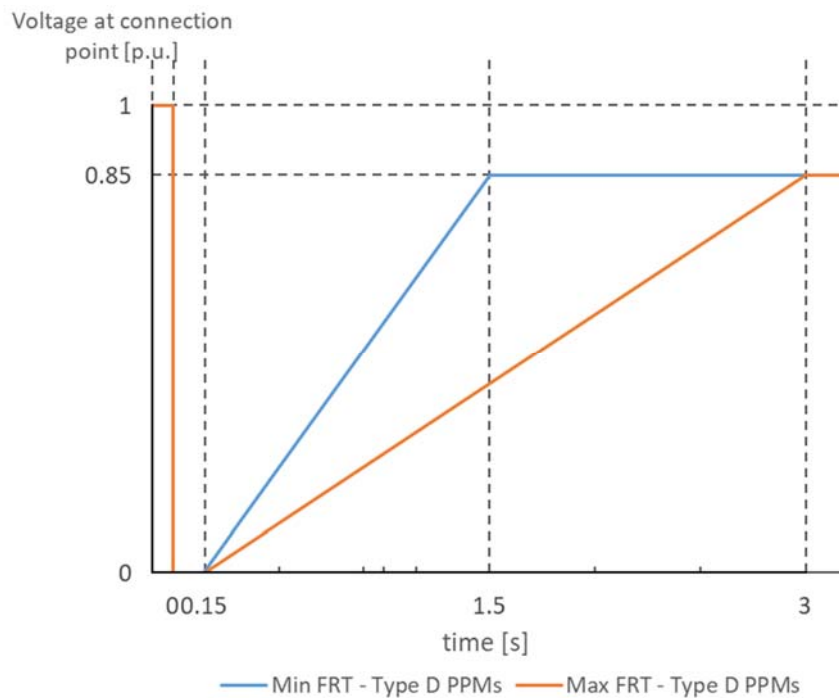

Figure 36- Min and max possible FRT requirement for type D PPMs connected at or above 110kV

From TSO's and DSO's standpoints FRT requirements is of different importance. For modules connected to transmission system, TSOs would like for modules to stay connected to the grid in case of secured faults, thus helping to maintain overall system frequency stability. In the situation when there is shift from bulk generation connected to the transmission system to distributed generation connected to distribution network, this reasoning would apply also to modules connected to distribution network. On the other hand, as stated in [24], when it comes to power generating modules connected to LV network (<1 kV) it is important that generating units stop with generation in case of the fault in distribution network, usually recognized through loss of mains voltage. In this way safety is guaranteed for both general public and distribution employees. One solution to this problem could be to determine type A and B power limit threshold in a way to ensure that all of the PGMs connected to LV are of type A. If this is not possible, then DSOs should consider safety aspects of possibility to have live LV network in case of the fault in distribution network. If used protection schemes cannot differentiate between transient fault and loss of mains than DSO should certainly consider to propose type B PGMs connected to LV network for derogation from FRT requirement.

In the case of conventional SPGMs, parameter having the most impact on module's capability to stay connected during secured system fault is unit's overall inertia. In order to create requirement that will be feasible from both technical and economic standpoint, requirement should be in line with capabilities of state of the art generating units and PPMs available on market today. In order to construct such requirement series of FRT calculations for units under consideration should be performed, for faults producing different voltage values at unit's connection point. These calculations should be performed for transient faults (i.e. faults without disconnection of faulted equipment) and for faults that lead to disconnection of faulted equipment. These calculations should be performed for existing and perspective connection points in the system. Regarding pre-fault operating conditions TSOs could perform calculation for each connection point for typical scenarios considered in the development phase (usually winter maximum, summer maximum and spring minimum), but from the standpoint of fault ride through capability it is expected that the most critical scenario is spring minimum, when the unit is operating in under-excitation. Because SPGM's inertia is main contributing factor when it comes to FRT requirement, it would be good that RSOs perform these analyses for existing relevant units, if the existing total system inertia is satisfactory, in order to create sort of a baseline.

According to the consultant expertise recommendation for Type D SPGMs connected with connection point at or above 110 kV, as a results of the before mentioned calculations for typical units are given

in Figure 37 and Table 11. Having in mind that RES penetration at this moment is still not significant regarding FRT capability of Type D PPMs connected at or above 110 kV, minimum FRT requirement as presented in Figure 36 and Table 11 could be implemented. For SPGMs connected below 110 kV recommended requirement is given in Figure 38 and Table 12. It should be noted that fault clearing time is assumed to be 200 ms. As previously said this allows for the upper limit of 150 ms to be exceeded. This should be coordinated to DSO’s protection scheme practice. As in the case of Type D PPMs, for type B, C and D PPMs connected below 110 kV, it is recommended that at this stage minimum FRT requirement is implemented, as shown in Figure 39 and Table 12, but with fault clearing time of 200 ms.

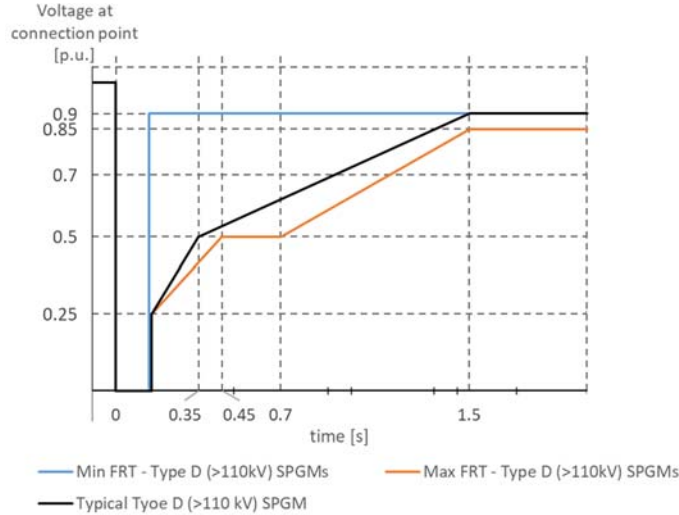

Figure 37 - Min and max possible FRT requirement, and typical response of type D SPGM connected at or above 110kV

Table 11 - Proposed Type D (U>110 kV) PGM FRT requirement

Type D (>110 kV) SPGMs				Type D (>110 kV) PPMs			
Voltage parameters (pu)		Time parameters (s)		Voltage parameters (pu)		Time parameters (s)	
U_{ret} :	0	t_{clear} :	0.15	U_{ret} :	0	t_{clear} :	0.15
U_{clear} :	0.25	t_{rec1} :	t_{clear}	U_{clear} :	U_{ret}	t_{rec1} :	t_{clear}
U_{rec1} :	0.5	t_{rec2} :	0.35	U_{rec1} :	U_{clear}	t_{rec2} :	t_{rec1}
U_{rec2} :	0.9	t_{rec3} :	1.5	U_{rec2} :	0.85	t_{rec3} :	1.5

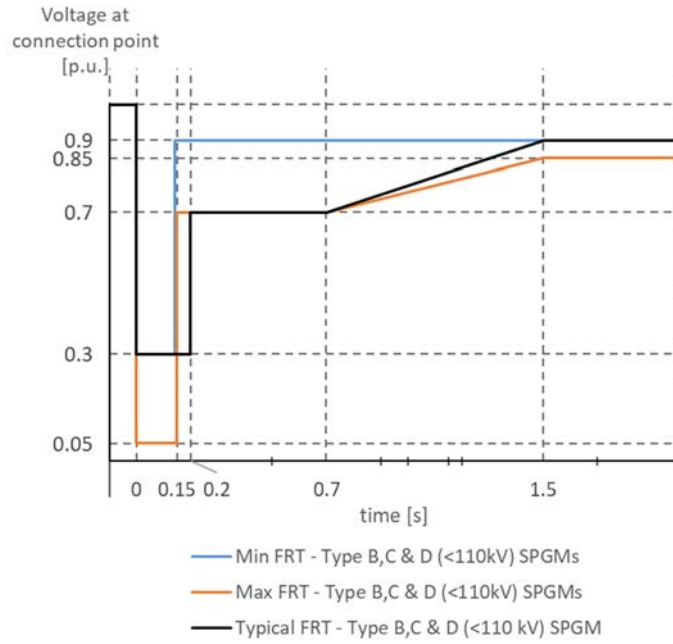

Figure 38- Min and max possible FRT requirement, and typical response of type A, B, C and D SPGMs connected below 110kV

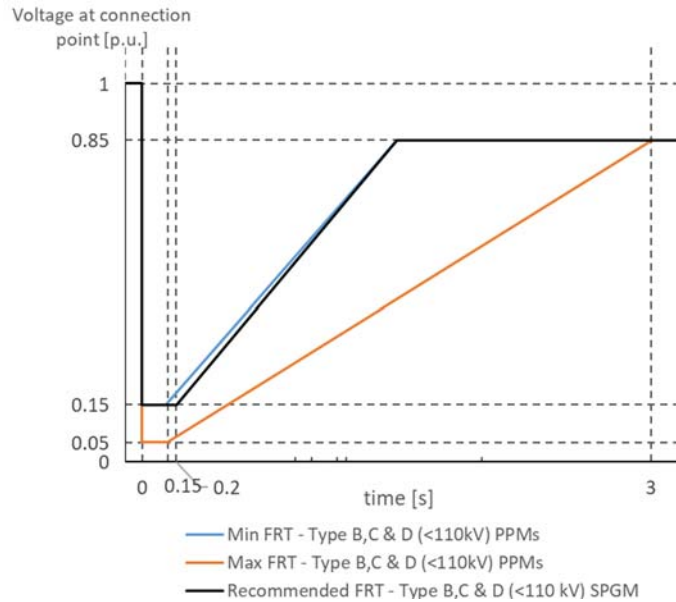

Figure 39 - Min and max possible FRT requirement for type A, B, C and D PPMs connected below 110kV

Table 12 - Proposed Type B, C and D (U<110 kV) PGM FRT requirement

Type B, C and D (<110 kV) SPGMs				Type B, C and D (<110 kV) PPMs			
Voltage parameters (pu)		Time parameters (s)		Voltage parameters (pu)		Time parameters (s)	
U_{ret} :	0.3	t_{clear} :	0.2	U_{ret} :	0.15	t_{clear} :	0.2
U_{clear} :	0.7	t_{rec1} :	t_{clear}	U_{clear} :	U_{ret}	t_{rec1} :	t_{clear}
U_{rec1} :	U_{clear}	t_{rec2} :	0.7	U_{rec1} :	U_{clear}	t_{rec2} :	t_{rec1}
U_{rec2} :	0.9	t_{rec3} :	1.5	U_{rec2} :	0.85	t_{rec3} :	1.5

Regarding pre-fault and post-fault conditions for the fault-ride-through capability, i.e. pre-fault minimum short circuit capacity at the connection point, pre-fault active and reactive power operating point of the power-generating module at the connection point and voltage at the connection point, and the post-fault minimum short circuit capacity at the connection point, RSO/TSO is obliged that it should make these information publicly available. This information can be provided by the RSO/TSO to perspective PGFO when they express interest for construction and connection of the power plant to

the RSO/TSO. This can be done as part of connection process phase, when PGFO submits connection request, but before technical requirements are issued, or before formal connection process if perspective PGFO formally expresses its interest for plant construction to RSO/TSO.

2.3.3. Automatic Disconnection due to Voltage Level

Non-exhaustive Requirement	Settings for automatic disconnection of PGMs
Article 15.3:	<i>“3. With regard to voltage stability, type C power-generating modules shall be capable of automatic disconnection when voltage at the connection point reaches levels specified by the relevant system operator in coordination with the relevant TSO. The terms and settings for actual automatic disconnection of power-generating modules shall be specified by the relevant system operator in coordination with the relevant TSO.”</i>
Applicability:	Type C, D PGMs
Mandatory	
Site specific	
ENTSO-E Practice	Usually implemented as site specific requirement. When given values are within the range $U < 0.8$ p.u. and $U > 1.2$ p.u.
Non-exhaustive Requirement	Definition of threshold for automatic disconnection
Article 16.2(c):	<i>“(c) without prejudice to point (a), the relevant system operator in coordination with the relevant TSO shall have the right to specify voltages at the connection point at which a power-generating module is capable of automatic disconnection. The terms and settings for automatic disconnection shall be agreed between the relevant system operator and the power-generating facility owner.”</i>
Applicability:	Type C, D PGMs
Non-mandatory	
Site specific	
ENTSO-E Practice	Usually implemented as site specific requirement

This site specific requirement should be defined by the RSO during the connection phase of the unit, but in due time for plant design, as it is the case for all the other site specific requirements.

2.3.4. Reactive Power Capability

Non-exhaustive Requirement	<i>Reactive power capability</i>
Articles 17.2(a):	<i>“with regard to reactive power capability, the relevant system operator shall have the right to specify the capability of a synchronous power-generating module to provide reactive power;”</i>
20.2(a):	<i>“with regard to reactive power capability, the relevant system operator shall have the right to specify the capability of a power park module to provide reactive power;”</i>
Applicability:	Type B SPGMs (Article 17.2(a)); Type B PPMs (Article 20.2(a))
Non - Mandatory	
Dependencies:	Reactive power capability below maximum capacity
ENTSO-E Practice	Different requirements are used. For more information see Appendix 4 .
Non-exhaustive Requirement	<i>Reactive power capability at maximum capacity i.e. U-Q/Pmax profile</i>
18.2(b):	<p><i>“with regard to reactive power capability at maximum capacity:</i></p> <p><i>(i) the relevant system operator in coordination with the relevant TSO shall specify the reactive power provision capability requirements in the context of varying voltage. For that purpose the relevant system operator shall specify a U-Q/Pmax-profile within the boundaries of which the synchronous power-generating module shall be capable of providing reactive power at its maximum capacity. The specified U-Q/Pmax profile may take any shape, having regard to the potential costs of delivering the capability to provide reactive power production at high voltages and reactive power consumption at low voltages;</i></p> <p><i>(ii) the U-Q/Pmax-profile shall be specified by the relevant system operator in coordination with the relevant TSO, in conformity with the following principles:</i></p> <ul style="list-style-type: none"> <i>• the U-Q/Pmax-profile shall not exceed the U-Q/Pmax-profile envelope, represented by the inner envelope in Figure 7,</i> <i>• the dimensions of the U-Q/Pmax-profile envelope (Q/Pmax range and voltage range) shall be within the range specified for each synchronous area in Table 8, and</i> <i>• the position of the U-Q/Pmax-profile envelope shall be within the limits of the fixed outer envelope in Figure 7;”</i> <p><i>(iii) the reactive power provision capability requirement applies at the connection point. For profile shapes other than rectangular, the voltage range represents the highest and lowest values. The full reactive power range is therefore not expected to be available across the range of steady-state voltages;</i></p> <p><i>(iv) the synchronous power-generating module shall be capable of moving to any operating point within its U-Q/Pmax profile in appropriate timescales to target values requested by the relevant system operator;</i></p>
Applicability:	Type C and D SPGMs
Mandatory	

Dependencies:	Reactive power capability below maximum capacity
ENTSO-E Practice	Different requirements are used. For more information see Appendix 4 .
Non-exhaustive Requirement	<i>Reactive power capability at maximum capacity i.e. U-Q/Pmax profile</i>
Articles 21.3(b):	<p><i>“with regard to reactive power capability at maximum capacity:</i></p> <p><i>(i) the relevant system operator in coordination with the relevant TSO shall specify the reactive power provision capability requirements in the context of varying voltage. To that end, it shall specify a U-Q/Pmax-profile that may take any shape within the boundaries of which the power park module shall be capable of providing reactive power at its maximum capacity;</i></p> <p><i>(ii) the U-Q/Pmax-profile shall be specified by each relevant system operator in coordination with the relevant TSO in conformity with the following principles:</i></p> <ul style="list-style-type: none"> <i>• the U-Q/Pmax-profile shall not exceed the U-Q/Pmax-profile envelope, represented by the inner envelope in Figure 8,</i> <i>• the dimensions of the U-Q/Pmax-profile envelope (Q/Pmax range and voltage range) shall be within the values specified for each synchronous area in Table 9,</i> <i>• the position of the U-Q/Pmax-profile envelope shall be within the limits of the fixed outer envelope set out in Figure 8, and</i> <i>• the specified U-Q/Pmax profile may take any shape, having regard to the potential costs of delivering the capability to provide reactive power production at high voltages and reactive power consumption at low voltages;”</i>
Applicability:	Type C and D PPMs
Mandatory	
Dependencies:	Reactive power capability below maximum capacity
ENTSO-E Practice	Different requirements are used. For more information see Appendix 4 .

For type B PGMs RfG defines reactive power capabilities as non-mandatory requirement (see Article 17.2(a) and Article 20.2(a)). If RSO chooses to make this requirement mandatory at national level than it is recommended that it specifies minimally required rated leading and lagging power factor of the machine, but considering typical values of these parameters (typical values of power factor parameters are given in following paragraphs).

For type C and D PGMs, on the other hand reactive power capability is explicitly introduced as mandatory. Relevant RfG articles define this requirement according to fixed outer envelope, and an inner envelope that can be moved inside outer envelope. Parameters of these envelopes are given in RfG Table 8 for SPGMs and RfG Table 9 for PPMs. Shape of these envelopes are rectangular, and they are shown here in Figure 40 and Figure 41. At this point it should be noted that the idea behind such wide voltage-var envelopes was not to introduce strict requirements to PGMs, that wouldn't be feasible. Given ranges are maximum possible ones, but smaller ranges can be used when implementing this requirement. As stated in [24] the set rectangular envelope shape should allow each TSO to continue to use existing voltage-var requirements, provided that they are well proven in practice. Typical generator voltage-var capability will not be rectangular but rather slanted rectangular or rhomboidal shape (see Figure 42).

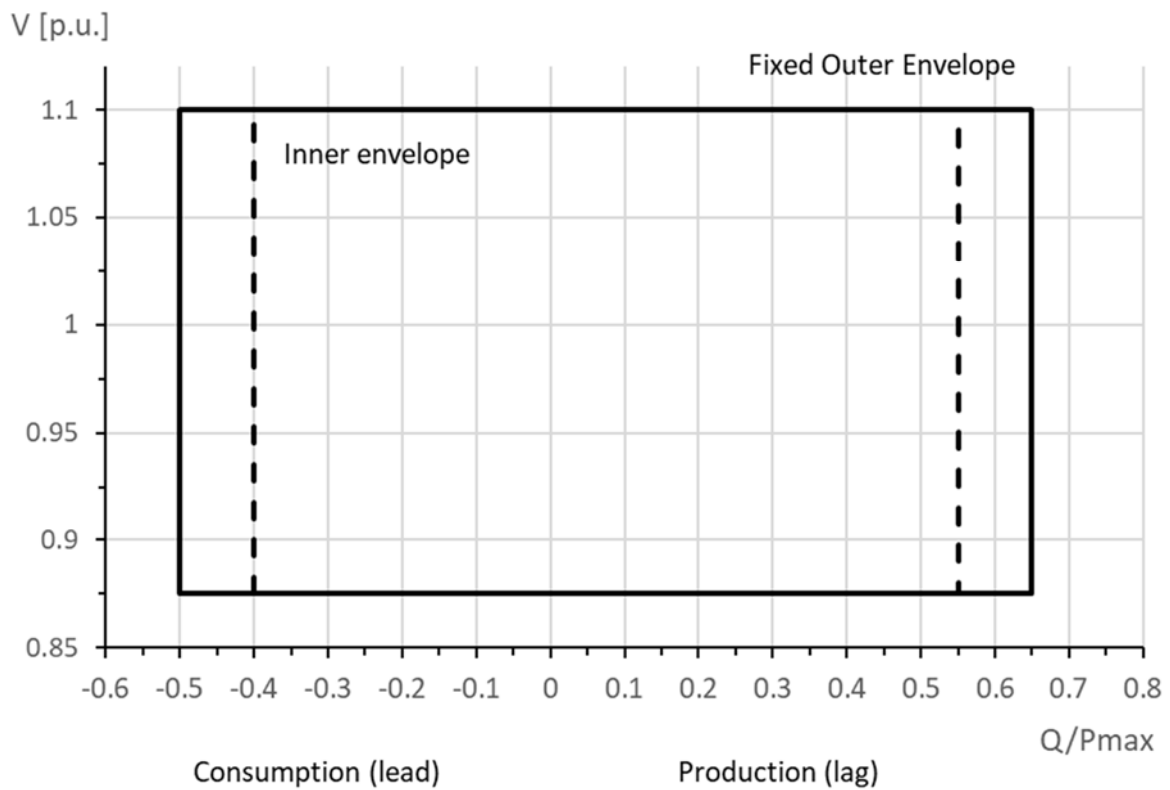

Figure 40 - U-Q/Pmax profile envelopes applicable to type C and D SPGMs

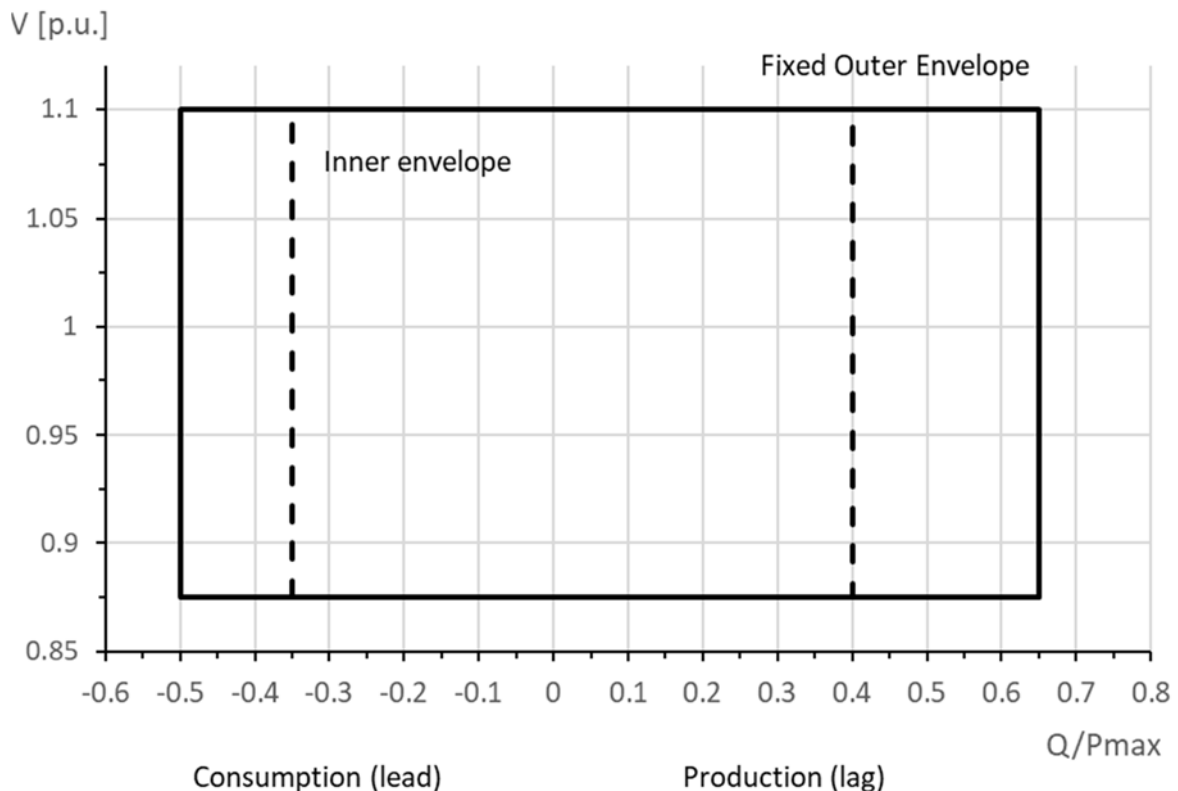

Figure 41 - U-Q/Pmax profile envelopes applicable to type C and D PPMs

Capability of SPGM to produce/consume reactive power at different voltage level at connection point will depend on unit's parameters, mainly: maximum reactive power at underexcitation and overexcitation at maximum active power, permissible voltage deviation at generator terminals, unit-transformer's short circuit impedance and unit transformers transformation ratio.

Maximum reactive power that generator can produce and consume at maximum active power will depend on generator's construction. These values can be read from P-Q capability diagram. Maximum

value of reactive power that the generator can produce at maximum active power is defined by generator's rated lagging power factor. According to standard IEC 60034-3, applicable to steam and gas turbine powered synchronous generators with rated capacity at or above 10 MVA, standard values for this parameter are 0.8, 0.85 and 0.9. According to standards: IEEE Std. C50.12 applicable to synchronous generators and generator/motors for hydraulic turbine applications rated 5 MVA and above, and IEEE Std. C50.13 applicable to cylindrical-rotor synchronous generators rated 10 MVA and above, power factor values of 0.8, 0.85 and 0.9 are also considered typical. IEEE Std. C50.13 further specifies that for hydrogen cooled cylindrical-rotor generators typical rated lagging power factor values are 0.85 and 0.9. As stated in IEEE Std. C50.13 *"if not specified by the purchaser, the rated power factor shall be 0.90"*. Lower values of rated lagging power factor will require higher rated apparent power, leading to larger machine and overall higher equipment costs. For TPP generators common values for rated lagging power factor are 0.85 and 0.9, and for HPP values of 0.8 and 0.85 are common.

When it comes to the value of leading power factor IEC 60034-1 states that *"it is recommended that the generator should be capable of providing 0.95 underexcited power factor at rated MW"*. Same is also stated in IEEE Std. C50-13 for both air-cooled and hydrogen-cooled generators. Generators capability to consume reactive power (i.e. to operate in underexcitation region) is limited by steady-state stability requirements or core end region heating. Core end region heating problem is more pronounced in synchronous machines with round rotor, and it is dependent on the generator construction. Steady-state stability limit for generator's operation in underexcitation region is determined by the theoretical and practical stability limits. Theoretical stability limit is the line in P-Q capability diagram corresponding to zero value of synchronization power. In case of round rotor machine this limit is straight line that intersects Q axis at $-1/X_d$. In the case of salient pole machine, where $X_d \neq X_q$, theoretical stability limit corresponds to parabola in P-Q plane intersecting Q axis at $-1/X_d$. In practice it is usual to adopt some safety margin from this theoretical stability limit. Stability limit with introduced safety margin is called practical stability limit. This limit is usually constructed in a way that each point on theoretical stability limit is moved on the constant EMF circle with appropriate safety margin, usually 10% of rated power. This gives practical stability limit that is of parabolic shape (for both TPP and HPP generators), but in most cases this limit can be approximated with straight line intersecting Q axis at $-1/X_d$, with slope (i.e. load angle) of around 70° . This is common representation of practical stability limit in P-Q capability diagrams. Depending on machine parameters it may be possible that stability is not limiting factor in underexcitation region of operation, as it would be the case when both X_d and X_q are less than 1 pu (as can be the case with some salient pole machines).

The previous analysis corresponds to synchronous machine operated with constant field current or constant EMF. However, for the synchronous machines with fast acting AVRs under automatic voltage control, stability limit is increased (analysis explaining this effect is beyond scope of this report). With regard to steady-state stability limit, as stated in IEEE Std. C50.12 and IEEE Std. C50.13 *"with modern automatic voltage regulators this limit can be significantly extended, particularly if sophisticated features such as a "power system stabilizer" are included to avoid any system dynamic stability issues as a result of fast regulator action"*. Depending on the field winding and excitation system capabilities it could be possible to reach load angle values close to 90° . Some manufacturers require that if machine is to be operated in such severe under excitation regimes (i.e. lagging power factor lower than 0.95) the generator AVR should be equipped with load angle limiter. Also the crude stability analysis given here considers synchronous machine with all external reactances neglected (as it is usually when capability diagrams of the machine are constructed). In the case of the machine synchronized to power system, stability limit should be determined according to critical angle between equivalent network voltage and EMF phasors.

As previously stated in section 2.3.1, IEC standard 60034-1 and 60034-3 define that maximum permanent voltage deviation at generator terminals is $\pm 5\%$. As stated also in that section in the case of salient pole machines lower values can be commonly found in practice, but this will depend on machine's construction. It should be noted that even if possible, lower operating voltages call for larger current values to achieve same power which in turn calls for more copper for windings. Higher operating voltages, on the other hand, means that core should be larger in order not to exceed

maximum flux density. In both cases requirement for larger voltage variations leads to larger machines and greater equipment costs.

As stated in section 2.3.1 if it is needed from generating module to operate under greater voltage variations than generator can handle it is customary to use unit step-up transformer with OLTC of appropriate rating. The effect of OLTC is such that by changing OLTC tap the overall voltage-var characteristic of PGM is translated up or down. It should be noted that OLTC should be used in stationary operating conditions, and that manipulation of OLTC may call for some sort of control scheme to coordinate OLTC operation with AVR in order to avoid having two systems trying to control same parameter, in this case generator terminal voltage, in the same time.

Because of reactive power losses on the unit transformer's impedance, PGM's voltage-var characteristic at generator terminals is different than voltage-var characteristic at connection point. Reactive power losses will shift overall characteristic toward underexcitation area. According to IEC 60909-2 standard typical values of unit transformer short circuit impedance is between 10% and 15%. This standard provides crude formula for estimating typical short circuit impedance for two winding transformers according to transformer's rated apparent power (S_{rT}) as:

$$u_{k,r}[\%] = 8 + 0.92 \ln S_{rT} [MVA]^9$$

For each value of active loading, value of voltage at connection point and maximum and minimum allowed voltage values at generator terminals, reactive power available at connection point can be calculated as:

$$P_{max} = \frac{U_G U_{net}}{u_{k,r}} \sin \theta$$

$$Q_G = \frac{U_G^2}{u_{k,r}} - \frac{U_G U_{net}}{u_{k,r}} \cos \theta$$

$$Q_M = Q_G - u_{k,r} \frac{P_{max}^2 + Q_G^2}{U_G^2}$$

where U_{net} is voltage at connected point expressed at generator terminals' level (i.e. transformed with transformer's transformation ratio), U_G is voltage value at generator terminals, and θ is angle between U_G and U_{net} phasors. All values are given in per unit.

Using previous equations with constraints that U_G and Q_G have to be between maximum and minimum allowed values, PGM's maximum voltage-var characteristic can be constructed. In this way voltage-var characteristic of typical SPGM is constructed and given in Figure 42. According to the previously stated typical SPGM is considered to have following parameters: rated lagging power factor 0.85, leading power factor at rated output 0.95, allowable voltage variations at generator terminals $\pm 5\%$, step-up transformer's rated short circuit impedance 12%.

⁹ This formula doesn't reflect some empirical design rule or practice, but rather results of conducted survey

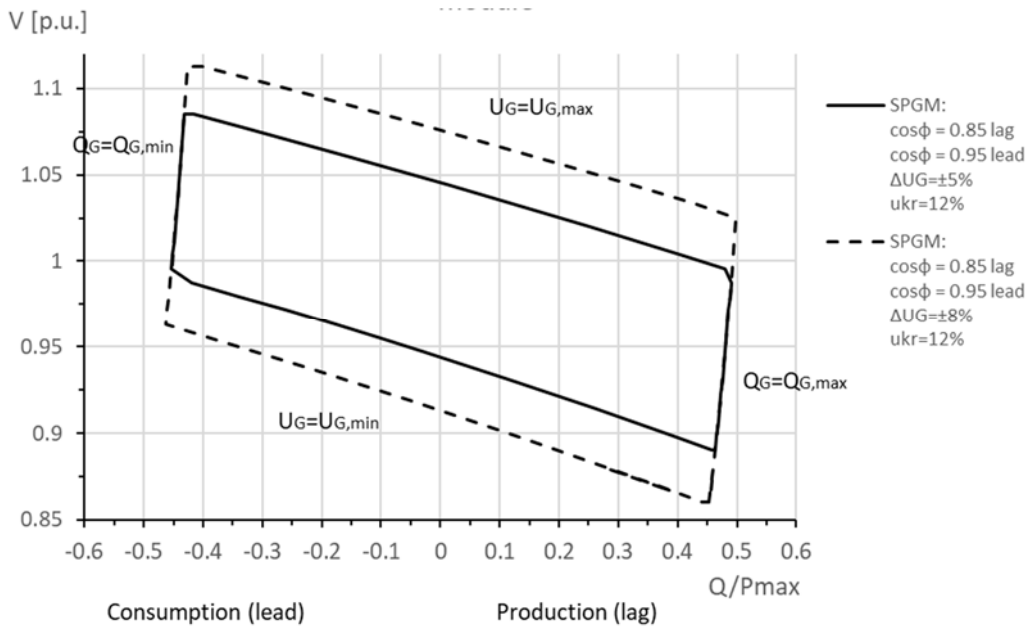

Figure 42 - Typical SPGM voltage-var characteristic

As it can be seen in Figure 42 PGM's characteristic is not rectangular. The shape is typical and it shows that when voltage is beyond certain value in order to deliver maximum reactive power to the network generator terminal voltage should be greater than its maximum value. Because of that maximum reactive power that can be produced is no longer limiting factor. Instead maximum voltage at generator terminals becomes limiting factor. The same is true for voltage below certain values. In other words generators inherently have limited capacities regarding production of reactive power in case of high voltage levels at connection point, and reactive power consumption in case of low voltage levels at connection point. This can be overcome with the use of OLTC. Other thing that should be kept in mind is that typical voltage-var characteristic in upper left corner and lower right corner ends in single point. At upper left corner $Q_G = Q_{G,min}$ and $U_G = U_{G,max}$ and in the lower right corner $Q_G = Q_{G,max}$ and $U_G = U_{G,min}$. At these points generator unit is not able to operate as P-V node, as it should, and instead it operates as P-Q node, which is not recommended for units intended to provide voltage regulation.

One last factor that can contribute to PGM's voltage-var characteristic is amount of self-consumption supplied from generator terminals. This can have certain effect in case of TPPs that can have self-consumption supplied from generator's terminals in excess of 10% of rated power with power factor as low as 0.8 lagging. Regarding PPM's P-Q capability they are usually defined as D-shape, rectangular or triangle shape as shown in Figure 47. As stated in [26] PPM inverters are usually capable of operating under voltage deviations of $\pm 10\%$ of rated terminal voltage.

When constructing the requirement tailored to system's needs, one should consider typical generator's capabilities, as previously described, but also system needs. The system needs could be estimated according to historical values of active and reactive power and voltage values at connection point and from values of before mentioned parameters calculated during system planning phase. Values of reactive power against voltage value can be then presented in U-Q/ P_{max} plane as shown in Figure 43 or Figure 44. Voltage-var requirement can be then set in a way to encompass the most of the achieved operating points, as shown in Figure 44. It should be noted that regarding width of voltage-var requirement there is not much that can be done, other than requiring machine with non-standard power factor values (both leading and lagging), but as previously said this leads to higher equipment costs and CB analysis should be performed in order to determine whether this is the most effective way to satisfy system reactive power needs (other solutions would include installation of static or synchronous compensators). With regard to voltage-var requirement height, for reasonable values of voltage range, PGM will be able to satisfy set requirements if OLTC with appropriate range is used.

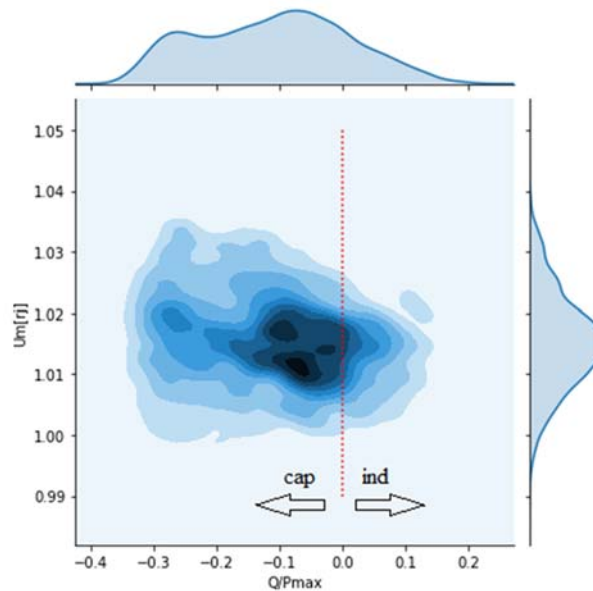

Figure 43 - A possible way to represent system reactive power needs at connection point

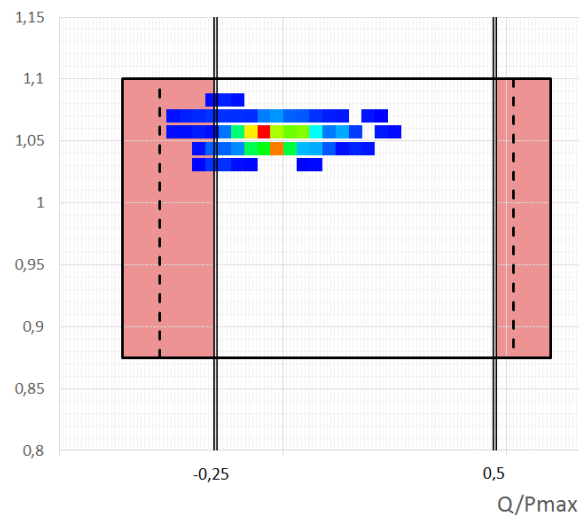

Figure 44 - Setting Q/P_{max} limits to encompass the most occurring operating points (in this case around 95%)

Having in mind previously stated about typical generator power factor values, recommendation is that for type B SPGMs power factor at generator terminals of 0.9 lagging and 0.95 leading is required. For type B PPMs it could be simple defined to require from PPM to be able to operate with power factor from 0.95 leading to 0.95 lagging (i.e. $Q/P_{max} \pm 0.33$), or the same requirement as type C and D PPMs could be applied. Because the scope of this project does not call for input data regarding system needs in form previously described, recommended requirement will be constructed according to the reactive power or power factor requirements that currently exist in the grid codes¹⁰, and in cases where such requirements do not exist according to typical PGM's parameters values. For SPGM following parameters will be considered typical: rated lagging power factor 0.85, leading power factor at rated output 0.95, allowable voltage variations at generator terminals $\pm 5\%$. Since the most of the countries are faced with high voltage problems, voltage-var characteristic will be constructed also for the whole allowed operating voltage range. In this case following principle will be applied: for highest allowed voltage PGMs will not be required to generate reactive power, and for the lowest voltage values PGMs will not be required to consume reactive power. Requirement constructed in this way will require the use of OLTC. Also maximum considered step-up transformer's rated short circuit impedance of 15% will be used in calculations. In the case of PPMs capability as required in section *Reactive Power*

¹⁰ In case that grid code has already defined voltage-var characteristic that is in compliance with RfG requirements RSO should continue to use such requirement

Capability below maximum power will be used together with allowable voltage variations at terminals $\pm 10\%$, step-up transformer's rated short circuit impedance 12%. As in the case of SPGMs voltage-var characteristic for PPMs will be constructed also for the whole allowed operating voltage range, according to the same principle. Proposed requirement for type C and D SPGMs is given in Figure 45 and Table 13. Proposed requirement for type C and D PPMs is given in Figure 46 and Table 13. In order to fulfil set requirements OLTC is needed.

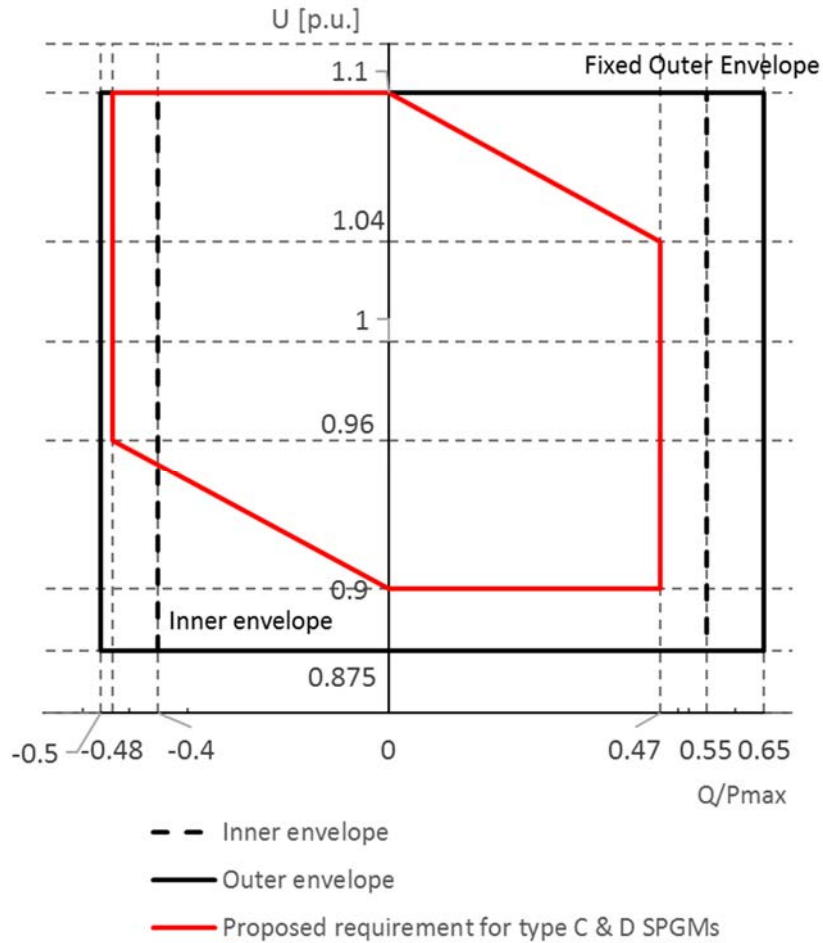

Figure 45 - Proposed U - Q/P_{max} requirement for type C and D SPGMs

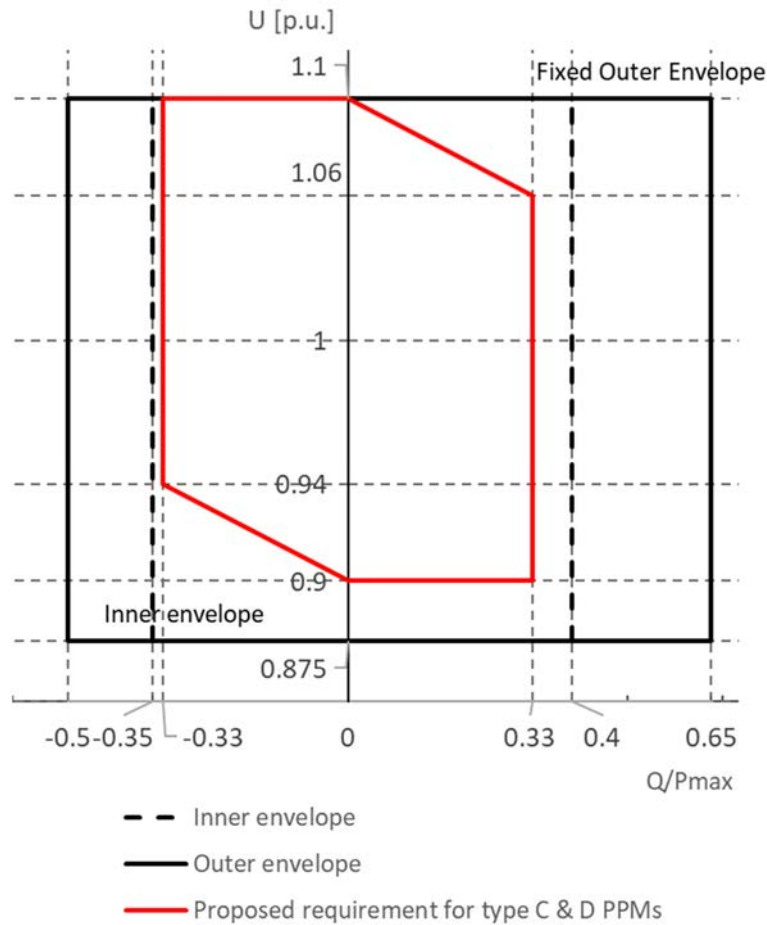

Figure 46 - Proposed U-Q/Pmax requirement for type C and D PPMs

With regard to timescale needed for SPGM to reach target values within its U-Q/Pmax profile this will depend on excitation system and generator characteristics, but also on the characteristic of the network in the connection point. Having in mind that there is no automatic secondary voltage control, in order to achieve requested reactive power for SPGMs operated in voltage control mode the plant operating personnel has to change AVR's reference point manually. This is done incrementally until requested reactive power is reached. At European level it seems that this requirement is differently implemented. In most case requirement is defined as "with undue delay" and some countries have defined target values, with highest value of 10 minutes (Germany). Having this in mind it is proposed that requirement is defined as follows:

The synchronous power-generating module shall be capable of moving to any operating point within its U-Q/Pmax profile with undue delay to target values requested by the relevant system operator, but no later than 10 minutes after the request is issued.

Table 13 - Proposed U-Q/Pmax requirement for type C and D SPGMs and PPMs

Type C and D SPGMs		Type C and D PPMs	
U	Q/Pmax	U	Q/Pmax
0.96	-0.48	0.94	-0.33
1.1	-0.48	1.1	-0.33
1.1	0	1.1	0
1.04	0.47	1.06	0.33
0.9	0.47	0.9	0.33
0.9	0	0.9	0

2.3.5. Reactive Power Capability below maximum power

Non-exhaustive Requirement	Reactive Power Capability below maximum power Appropriate timescale to reach any operating point within U- Q/Pmax-profile
Articles 21.3(c):	<p><i>“(c) with regard to reactive power capability below maximum capacity:</i></p> <p><i>(ii) the P-Q/Pmax-profile shall be specified by each relevant system operator in coordination with the relevant TSO, in conformity with the following principles:</i></p> <ul style="list-style-type: none"> • the P-Q/Pmax-profile shall not exceed the P-Q/Pmax-profile envelope, represented by the inner envelope in Figure 9, • the Q/Pmax range of the P-Q/Pmax-profile envelope is specified for each synchronous area in Table 9, • the active power range of the P-Q/Pmax-profile envelope at zero reactive power shall be 1 pu, • the P-Q/Pmax-profile can be of any shape and shall include conditions for reactive power capability at zero active power, and • the position of the P-Q/Pmax-profile envelope shall be within the limits of the fixed outer envelope set out in Figure 9; <p><i>(iii) when operating at an active power output below maximum capacity ($P < P_{max}$), the power park module shall be capable of providing reactive power at any operating point inside its P-Q/Pmax-profile, if all units of that power park module which generate power are technically available that is to say they are not out of service due to maintenance or failure, otherwise there may be less reactive power capability, taking into consideration the technical availabilities;</i></p> <p><i>The diagram represents boundaries of a P-Q/Pmax-profile at the connection point by the active power, expressed by the ratio of its actual value and the maximum capacity pu, against the ratio of the reactive power (Q) and the maximum capacity (Pmax). The position, size and shape of the inner envelope are indicative.</i></p> <p><i>(iv) the power park module shall be capable of moving to any operating point within its P-Q/Pmax profile in appropriate timescales to target values requested by the relevant system operator;</i></p>
Applicability:	Type C and D PPMs
Mandatory	For reactive power capabilities below Pmax different requirements are used. For more information see Figure 48.
ENTSO-E Practice	Regarding appropriate timescale to reach any operating point within U- Q/Pmax-profile this requirement is usually given in general terms (e.g. “as fast as possible”, “without undue delay”, etc). Where defined time intervals range from 10 s to 10 minutes.

For efficient voltage regulation in power system it is crucial that adequate amount of reactive power resources is at operators disposal, and that they are efficiently and effectively utilized. At the moment, main reactive power resources used in power systems are SPGMs. Other resources commonly used are compensation devices either static or synchronous. With more RES projects come to realization, contribution from PPMs becomes equally important. SPGMs can produce/consume reactive power equally well, and even better, below maximum active power capacity. On the other hand, capability of PE interfaced RES to produce/consume reactive power is dependent on their inverter capabilities. Capability of PE interfaced RES is usually of D-shape, rectangular or triangle shape, as given here in

Figure 47. As stated in [26] units with D-shape or rectangular capability characteristic may provide voltage regulation even when they are not producing active power, if operated in STATCOM mode.

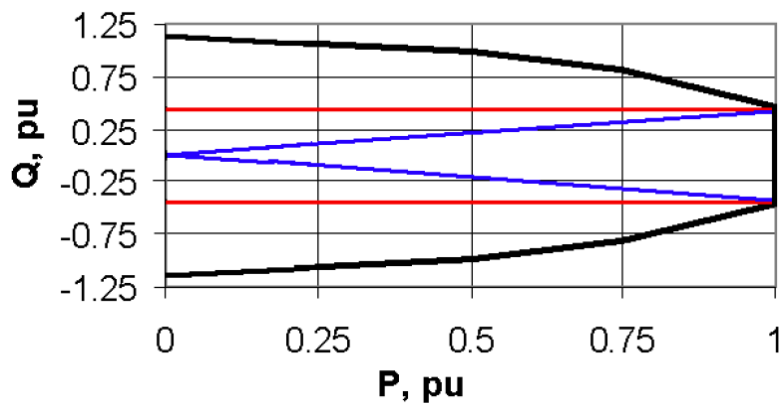

Figure 47 - Triangular, Rectangular and D-shape capability curve for 0.9 power factor at rated output (Source: [25] Figure 5)

At PPM level capability to produce/consume reactive power is dependent on PPM's output. Main reason for this dependency is because of different loading of PPM's ancillary equipment such as transformers and cables. That is why reactive power capacities of PPM can decrease when the PPM's output decreases, which makes it necessary for additional equipment to be installed in order to maintain same reactive power capabilities at connection point independent of loading.

CNC requires from the RSO to define reactive power capability below maximum capacity according to the envelope given in RfG Figure 9, given here in Figure 48. Basically RSO should define desired minimum capability curve of PPM. Beside constraints give in Figure 48 RfG Article 21(c)(ii) defines that "the active power range of the P-Q/Pmax-profile envelope at zero reactive power shall be 1 pu". Beside RfG inner and outer envelopes some of the implementations of this requirement at EU level countries are given¹¹ (P-Q/Pmax profiles were constructed according to values given in Table 23).

¹¹ Data source: <https://www.entsoe.eu/active-library/codes/cnc/>

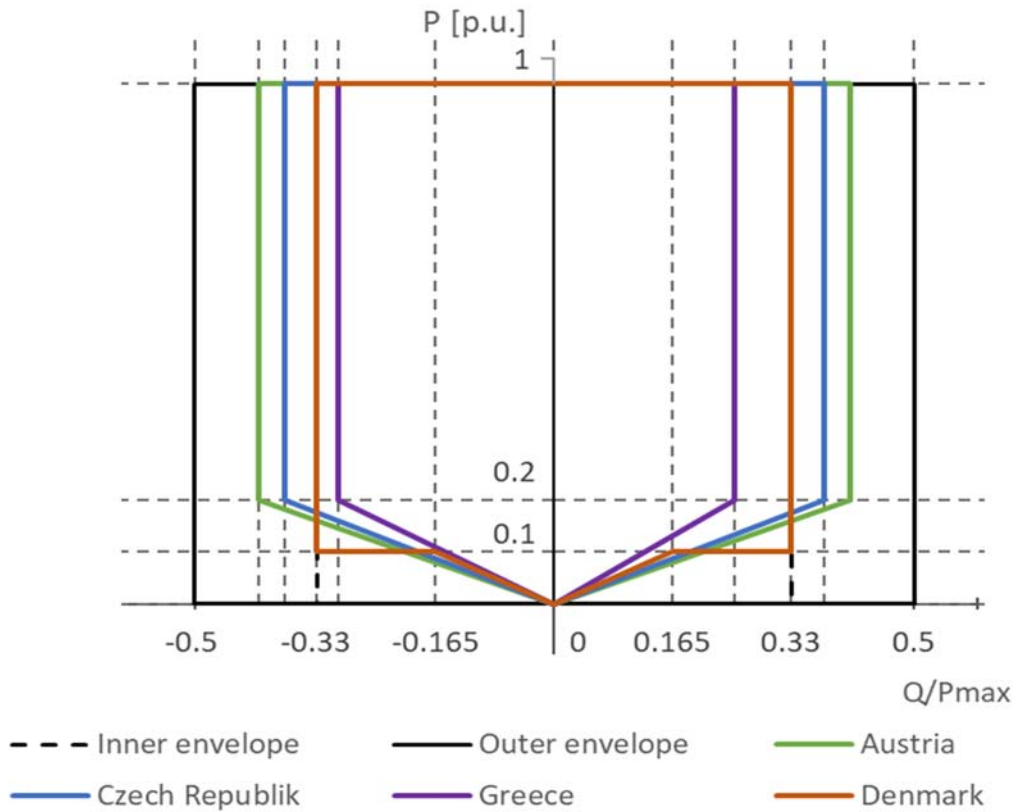

Figure 48 - Maximum size and position of P-Q/Pmax request and some of the requirements implemented in EU countries

Table 14 - Parameters of P-Q/Pmax curves drawn in Figure 48

Austria			Czech Republic			Greece			Denmark		
Q/P _{max}	P	cosφ ¹²	Q/P _{max}	P	cosφ	Q/P _{max}	P	cosφ	Q/P _{max}	P	cosφ
[p.u.]	[p.u.]		[p.u.]	[p.u.]		[p.u.]	[p.u.]		[p.u.]	[p.u.]	
0	0	lead/lag	0	0	lead/lag	0	0	lag	0.33	1	lead/lag
-0.411	0.2	0.925	-0.375	0.2	0.936	-0.3	0.2	0.97	0.33	0.1	0.95
-0.411	1		-0.375	1		-0.3	1	lead	0.165	0.1	
0.411	1		0.375	1		0.25	1	0.958	0	0	
0.411	0.2		0.375	0.2		0.25	0.2		-0.165	0.1	
									-0.33	0.1	
									-0.33	1	

As more and more RES are installed and connected, conventional SPGMs can become substituted. In the near future strict environmental protection requirements will lead to decommissioning of some coal powered TPPs. TPPs which stay in operation will have to comply with strict environmental requirements, which means that PGFOs will have to invest in additional equipment and measures in order to reduce environmental impact. This will lead to increase in variable prices of energy from this TPPs that can have impact on dispatching of these units, and possibly increased import. All this could lead to situations where there is lack of reactive power resources in the system in situations when there is small production from PGMs, e.g. majority of demand is supplied from import. In this cases it would be of benefit to have PPMs capable of producing/consuming reactive power adequately even below maximum capacity.

However, this does not mean that PPMs will be capable of satisfying all of the system’s reactive power needs. Additional measures may be needed in the future, mainly because SPGMs are going to be decommissioned or substituted by RES, and also because of the fact that RES plants can be generally worse co-located to the demand than TPPs are [24]. However, PPMs that are able to contribute to reactive power management even for lower active power production can have impact on overall

¹² Power factor at connection point at rated active power output

system with regard to reactive power management and voltage control. Efficiency of PGM’s reactive power contribution, will strongly depend on the location of PGM, i.e. from the fact whether the PGM and demand are electrically close or far away. With regard to voltage control and reactive power management the best situation is when the reactive power is produced/consumed as close as possible to the demand, because reactive power is poorly transferred over long distances, and produces greater losses in the network. However, analysis of PPMs’ impact to system voltage control, would require more in depth analysis. This kind of analysis should be done as part of system development, and they should be closely coordinated with DSO.

It is recommended to require that PPM have rectangular characteristic with lead/lag power factor equal to 0.95 at rated output at connection point, i.e. $Q/P_{max} = \pm 0.33$, up to minimum regulating level, i.e. 20% of rated active output. Below this value Q/P_{max} range should decrease linearly up to the pint $(P, Q/P_{max}) = (0, 0)$. Proposed requirement is given in Figure 49 and Table 15.

Table 15 - Proposed P-Q/Pmax envelope

P	Q/Pmax
1	0.33
0.2	0.33
0	0
0.2	-0.33
1	-0.33

With regard to timescale needed for PPM to reach target values within its P-Q/Pmax it seems that even at European level requirement is differently implemented. In most case requirement is defined as “with undue delay” and some countries have defined target values, with highest value of 10 minutes (Germany). Having this in mind it is proposed that requirement is defined as follows:

The power park module shall be capable of moving to any operating point within its P-Q/Pmax profile with undue delay to target values requested by the relevant system operator, but no later than 10 minutes after the request is issued.

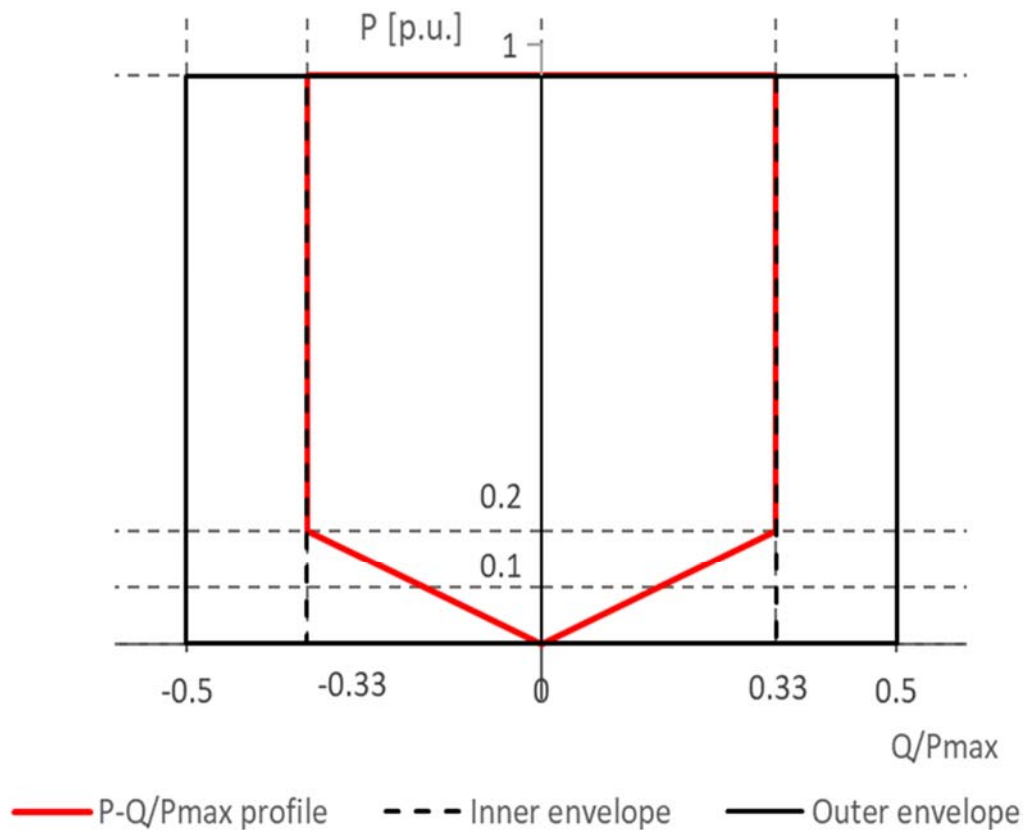

Figure 49 - Proposed P-Q/Pmax characteristics for PPMs Voltage/Reactive Power Control

2.3.5.1. Voltage Control

Non-exhaustive Requirement	Parameters and settings of the AVR Power threshold for PSS function
Articles	
19.2(a):	<i>“(a) the parameters and settings of the components of the voltage control system shall be agreed between the power generating facility owner and the relevant system operator, in coordination with the relevant TSO;”</i>
19.2(b):	<i>„b) the agreement referred to in subparagraph (a) shall cover the specifications and performance of an automatic voltage regulator (‘AVR’) with regard to steady-state voltage and transient voltage control and the specifications and performance of the excitation control system. The latter shall include:</i> <i>(i) bandwidth limitation of the output signal to ensure that the highest frequency of response cannot excite torsional oscillations on other power-generating modules connected to the network;</i> <i>(ii) an underexcitation limiter to prevent the AVR from reducing the alternator excitation to a level which would endanger synchronous stability;</i> <i>(iii) an overexcitation limiter to ensure that the alternator excitation is not limited to less than the maximum value that can be achieved whilst ensuring that the synchronous power-generating module is operating within its design limits;</i> <i>(iv) a stator current limiter; and</i>

(v) a PSS function to attenuate power oscillations, if the synchronous power-generating module size is above a value of maximum capacity specified by the relevant TSO.”

Applicability: Type D SPGMs

Mandatory

Site specific

**ENTSO-E
Practice**

Different requirements are used. For more information see [Appendix 5](#)

These requirements are site specific, except for requirement given in Article 19.2(b)(v) requiring TSO to specify power threshold value above which the SPGM’s AVR should be equipped with PSS. For this parameter values already used at national level should be used. If currently not defined than it would be recommended at the moment that all type D SPGMs have implemented PSS functionality. It should be noted however that determination of PSS parameters should be done according to detailed analysis (i.e. dynamic studies) performed by the TSOs.

2.3.5.2. Reactive Power Control

Non-exhaustive Requirement	Voltage control mode:
	<ul style="list-style-type: none"> t1: time within which 90% of the change in reactive power is reached t2: time within which 100% of the change in reactive power is reached
	Power factor control mode:
	<ul style="list-style-type: none"> Target power factor Time period to reach the set point Tolerance

Article 21.3(d): “3.Type C power park modules shall fulfil the following additional requirements in relation to voltage stability:

...

(d) with regard to reactive power control modes:

(i) the power park module shall be capable of providing reactive power automatically by either voltage control mode, reactive power control mode or power factor control mode;

(ii) for the purposes of voltage control mode, the power park module shall be capable of contributing to voltage control at the connection point by provision of reactive power exchange with the network with a setpoint voltage covering 0,95 to 1,05 pu in steps no greater than 0,01 pu, with a slope having a range of at least 2 to 7 % in steps no greater than 0,5 %. The reactive power output shall be zero when the grid voltage value at the connection point equals the voltage setpoint;

(iii) the setpoint may be operated with or without a deadband selectable in a range from zero to ± 5 % of reference 1 pu network voltage in steps no greater than 0,5 %;

(iv) following a step change in voltage, the power park module shall be capable of achieving 90 % of the change in reactive power output within a time t1 to be specified by the relevant system operator in the range of 1 to 5 seconds, and must settle at the value specified by the slope within a time t2 to be specified by the relevant system operator in the range of 5 to 60 seconds, with a steady-state

reactive tolerance no greater than 5 % of the maximum reactive power. The relevant system operator shall specify the time specifications;

(v) for the purpose of reactive power control mode, the power park module shall be capable of setting the reactive power setpoint anywhere in the reactive power range, specified by point (a) of Article 20(2) and by points (a) and (b) of Article 21(3), with setting steps no greater than 5 MVar or 5 % (whichever is smaller) of full reactive power, controlling the reactive power at the connection point to an accuracy within plus or minus 5 MVar or plus or minus 5 % (whichever is smaller) of the full reactive power;

(vi) for the purpose of power factor control mode, the power park module shall be capable of controlling the power factor at the connection point within the required reactive power range, specified by the relevant system operator according to point (a) of Article 20(2) or specified by points (a) and (b) of Article 21(3), with a target power factor in steps no greater than 0,01. The relevant system operator shall specify the target power factor value, its tolerance and the period of time to achieve the target power factor following a sudden change of active power output. The tolerance of the target power factor shall be expressed through the tolerance of its corresponding reactive power. This reactive power tolerance shall be expressed by either an absolute value or by a percentage of the maximum reactive power of the power park module;

(vii) the relevant system operator, in coordination with the relevant TSO and with the power park module owner, shall specify which of the above three reactive power control mode options and associated setpoints is to apply, and what further equipment is needed to make the adjustment of the relevant setpoint operable remotely,

Applicability: Type C and D PPMs

Mandatory

ENTSO-E Practice Different requirements are used. At some cases requirement is even implemented as site specific. For more information see [Appendix 5](#)

Non-exhaustive Requirement

Contribution to power oscillations damping

Article 21.3(f): “(f) with regard to power oscillations damping control, if specified by the relevant TSO a power park module shall be capable of contributing to damping power oscillations. The voltage and reactive power control characteristics of power park modules must not adversely affect the damping of power oscillations.”

Applicability: Type C and D PPMs

Non-Mandatory

This requirement is related to PPMs contribution to voltage stability in steady and quasi steady state. As stated in [21] reactive power control is a basic mechanism for achieving voltage control in electric network. Reactive power control is necessary in order to maintain voltages in permissible ranges and maintain voltage stability. As more and more PPMs are being connected to the grid it will be necessary to get voltage support from PPMs as well. In the case of type D PPMs connected to transmission system it is recommended that the PPMs are operated in voltage control mode, regulating voltage at connection point with pre-defined droop. For type C and D PPMs connected to DS recommendation is that these units are operated in power factor or reactive power control mode. This recommendation is generally applicable to PPMs connected to stiff bus compared to the plant size [26].

Regarding voltage regulation control mode the RSO needs to define time intervals t_1 and t_2 (Article 21.3(d)(iv)). These time intervals are usually referred to as rise time and settling times. These values are representative of feedback control system's small signal dynamic response. Even though [23] is concerned with SPGMs, same conclusion applies to PPMs as well, and that is that there are no generally acceptable ranges of values for these small signal parameters. These parameters are representative of how fast and stable control system response is. But as also pointed out in [23] "machines connected to a power system form a complex multiloop, multivariable high order control system", and it is recommended that in this case eigenvalue techniques should be used as an effective method of assessing the performance of the system.

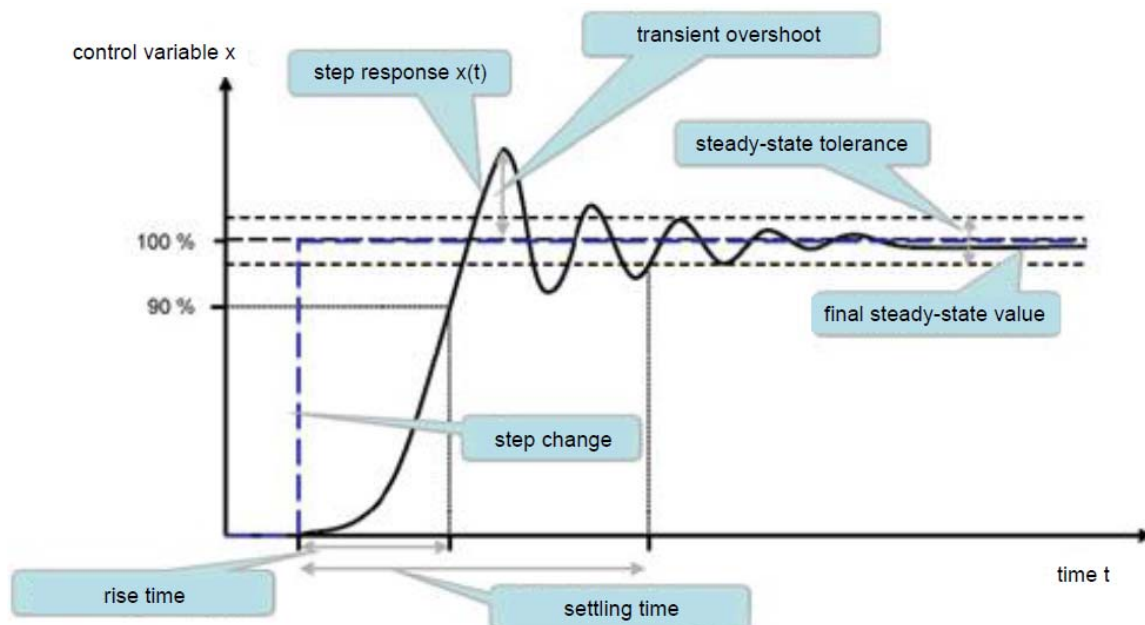

Figure 50 - Typical small signal response of feedback control system ([21])

Regarding voltage control mode illustration of reactive power droop and voltage deadband is given in Figure 51. Values give on horizontal axis correspond to voltage deviation from voltage regulation setpoint reference. Figure is representative of voltage deadband equal to 1% and droop value of 4%. Reactive power droop has the effect of compensating voltage drop on unit transformer's impedance. When deciding on value for droop value for each of the PGMs care should be taken not to overcompensate voltage drop on transformer's impedance as this can lead to instability.

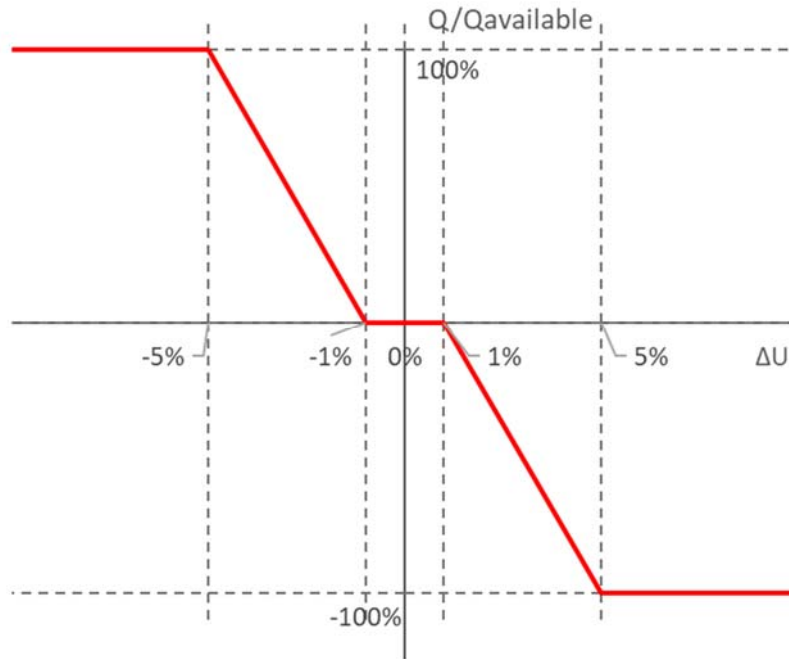

Figure 51 - Illustration of reactive power droop and voltage deadband

With regard to the implementation of this request according to the ENTSO-E latest implementation monitoring report¹³, it seems that there are ambiguities at EU level. According to the table given in ENTSO-E IGD [7] both requirement as such and value of requirement should be considered as general. However, it seems that some countries implement this requirement as site specific (e.g. Belgium, Germany, Greece, and Hungary). If this requirement is necessary to be implemented as general at national grid code then at this stage it is recommended to set requirements according to the most challenging allowed limiting values, according to the values given in Table 16.

Table 16 - Recommendation for reactive power control parameters for PPMs

Voltage control mode	Time needed for achieving 90 % of the change in reactive power output following a voltage step change	t1	1s
	Settling time for reactive power following a voltage step change	t2	5s
Power factor control mode	Power factor tolerance	±5%	
	Time period to achieve the target power factor following a sudden change of active power output	10s	

This kind of requirement should enable PPMs to be prepared to satisfy the most challenging requirements. The setting values that should be implemented upon the connection should be determined by the RSO during the connection phase.

¹³ <https://www.entsoe.eu/active-library/codes/cnc/>

2.3.6. Fast fault current capability

Non-exhaustive Requirement	Fast fault current capability parameters for symmetrical faults
Article 20.2(b):	<p><i>“(b) the relevant system operator in coordination with the relevant TSO shall have the right to specify that a power park module be capable of providing fast fault current at the connection point in case of symmetrical (3-phase) faults, under the following conditions:”</i></p> <p><i>(i) the power park module shall be capable of activating the supply of fast fault current either by:</i></p> <ul style="list-style-type: none"> <i>• ensuring the supply of the fast fault current at the connection point, or</i> <i>• measuring voltage deviations at the terminals of the individual units of the power park module and providing a fast fault current at the terminals of these units;”</i> <p><i>(ii) the relevant system operator in coordination with the relevant TSO shall specify:</i></p> <ul style="list-style-type: none"> <i>• how and when a voltage deviation is to be determined as well as the end of the voltage deviation,</i> <i>• the characteristics of the fast fault current, including the time domain for measuring the voltage deviation and fast fault current, for which current and voltage may be measured differently from the method specified in Article 2,</i> <i>• the timing and accuracy of the fast fault current, which may include several stages during a fault and after its clearance;”</i>
Applicability:	Type B, C and D PPMs
Non-mandatory	
Dependencies:	Synthetic Inertia
Non-exhaustive Requirement	Fast fault current capability parameters for asymmetrical faults
Article 20.2(c):	<p><i>“(c) with regard to the supply of fast fault current in case of asymmetrical (1-phase or 2-phase) faults, the relevant system operator in coordination with the relevant TSO shall have the right to specify a requirement for asymmetrical current injection.”</i></p>
Applicability:	Type B, C and D PPMs
Non-mandatory	
Dependencies:	Synthetic Inertia
Non-exhaustive Requirement	Priority to active or reactive power contribution
Article 21.3(e):	<p><i>“(e) with regard to prioritising active or reactive power contribution, the relevant TSO shall specify whether active power contribution or reactive power contribution has priority during faults for which fault-ride-through capability is</i></p>

required. If priority is given to active power contribution, this provision has to be established no later than 150 ms cvafrom the fault inception;”

Applicability: Type B, C and D PPMs

Non-mandatory

Dependencies: Synthetic Inertia

The requirement of fast fault contribution is applicable to PPMs. SPGMs inherently respond to any deviation in voltage at connection point. On the other hand, response of PEIPS will greatly depend on implemented control schemes. Besides the two before mentioned class of PGMs there are also WTGs using double fed induction generator that have rotor interfaced to the grid via PE and stator directly connected to the grid. Their response is different from PEIPS response, similar to SPGM’s response but not quite the same.

Regarding PPM’s needed response it will depend on current time period after the fault, overall system characteristics and grid topology. Regarding time period in [20] is proposed to consider 3 time periods after the fault inception (see Figure 52).

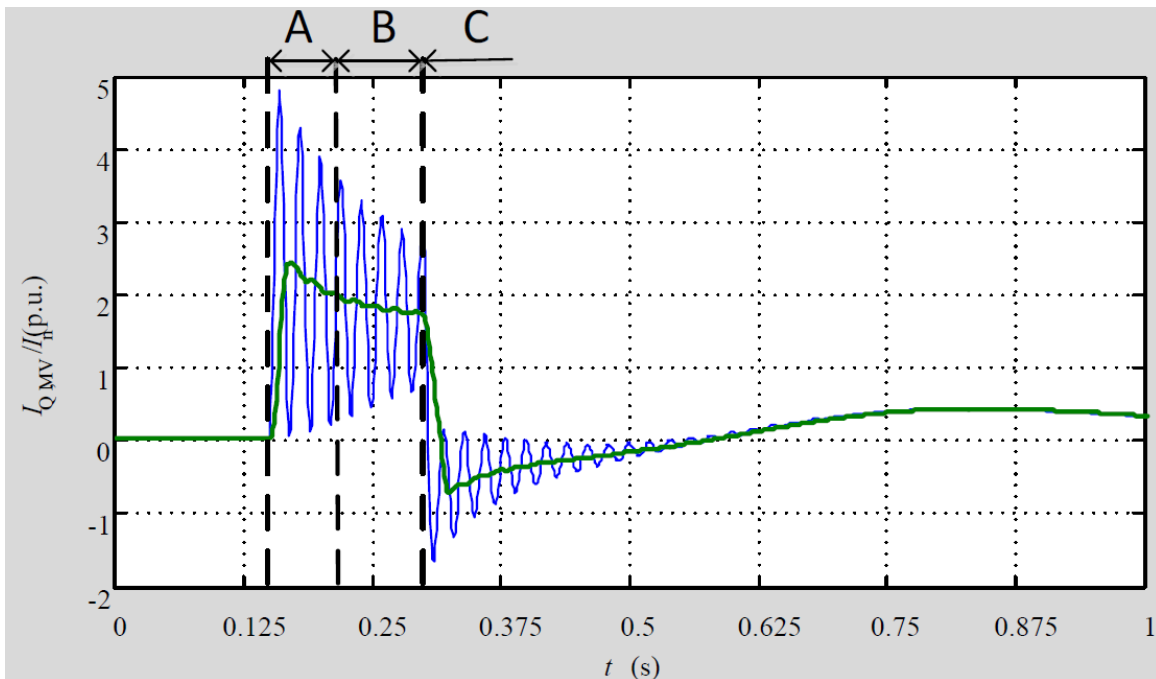

Figure 52 - Typical SPGM’s response to 3-phase fault (Data source: [20] Figure 1)

Blue trace in Figure 52 represent instantaneous phase current and green trace represent direct component of phase current. Time period after fault inception is divided into 3 intervals: period A, period B and period C. Time period A starts immediately after fault occurrence and lasts for one to two fundamental frequency period (i.e. up to 40 ms). During this time period main priority is for relay protection units to pick-up on fault. Time period B starts after time period A. At this time fault is still not cleared, but the protection devices should have picked-up. Time period B ends, and time period C starts after the fault is cleared.

Regarding system characteristics the desired response during time period B will differ. For small SA where frequency stability is critical PEIPS contribution should be directed towards active component contribution. For larger SA where frequency stability is not critical desired PEIPS respond should be towards reactive component contribution in order to contribute to voltage stability.

With regard to grid topology, desired response will be different for meshed and radial network. In case of meshed networks (such as transmission network) main concern during time period A is to ensure adequate response of protection devices (i.e. adequate fault clearing time and reach of distance

protection). On the other hand for radial networks, it should be provided that PEIPS does not lead to protection scheme insensitivity to fault conditions. This could happen in case of overcurrent and impedance protection function when there is PEIPS installed between circuit breaker and fault location. In this case PEIPS can contribute to increased voltage levels near fault location and thus preventing upstream network protection from pick-up. In this case it is desirable to maintain minimal contribution from PEIPS during time period A and B, but to ensure that they stay connected to the grid in order to help pre fault condition restoration after the fault is cleared (time period C).

Desired response is summarized in next table:

Table 17 - Desired Fast Fault Current capability

	SA		Grid topology	
	Small	Large	Meshed	Radial
Period A			Fast maximum current contribution	Limited response
Period B	Active current component contribution	Reactive current contribution	Aid voltage recovery and support first swing stability	
Period C	Contribute to pre-fault system condition restoration			

Regarding desired response characteristics at time periods A and B response accuracy is not crucial. During time period A crucial is response time (i.e. adequate response in first 40 ms following fault inception). On the other hand during time period C accuracy of response is crucial to avoid over voltages and other adverse condition, after the fault is cleared.

Regarding requirements how and when the voltage should be measured it will greatly depend on desired response speed. This also applies to type of measurements needed (i.e. instantaneous value, space vector or direct component). When considering desired response speed the effect that set requirement will have on other system response should be considered. This is more elaborated in section Synthetic inertia of the report. Therefore, holistic approach of system dynamic response is proposed in order to decide whether or not to implement this requirement at national level, and for determining desired requirement parameters.

Regarding fast fault current contribution during unbalanced faults, RfG permits TSO to introduce this requirement if it finds it needed. On one hand this kind of response eliminates problem of current infeed to phases that are not affected by the fault, which leads to overvoltage in healthy phases. On the other hand in order to achieve this contribution calculation of inverse component contribution is needed, which takes minimum one period of fundamental frequency, thus this kind of response can be considered helpful during time period B after the fault inception. The zero component is omitted from considerations because there is at least one delta connected transformer winding between PPM and fault location.

At the moment the recommendation is for the TSO's to perform analysis proposed in section Synthetic inertia of the report regularly as part of transmission system development plan analysis, and not to introduce this requirement at national level at the moment. As stated in the introductory statement of this report, non-mandatory RfG requirement can be implemented at national level at any given point if the need arises. This does not mean that the introduction of non-mandatory PEIPS related requirements should be unduly delayed. This can lead to more strict requirements that will be set upon future grid users once the requirements are introduced. This is why proposed analysis, including dynamic simulation should be regularly performed.

2.4. System Restoration Issues

2.4.1. Reconnection Capability

Non-exhaustive Requirement	Conditions for reconnection to the network after an incidental disconnection caused by network disturbance
Articles 14(4)(a)	<p>4. Type B power-generating modules shall fulfil the following requirements relating to system restoration:</p> <p>(a) the relevant TSO shall specify the conditions under which a power-generating module is capable of reconnecting to the network after an incidental disconnection caused by a network disturbance;</p>
Applicability:	Type B, C and D
Mandatory	
General	
ENTSO-E Practice	<p>Frequency ranges narrow than $47,5 < f < 51$ Hz</p> <p>Voltage ranges mostly $0,85 < u < 1,09$ pu</p> <p>Some TSO define time that u and f shall be within define ranges, practice is range 30 - 300 s.</p> <p>Rate of change of active power output is dominant 10% P_{max}/min</p> <p>Most TSO's have remark that automatic reconnection is forbidden for Type D</p>

Conditions for reconnection shall be the same as condition for Automatic Connection to the Network (subchapter 2.2.7):

- Voltage range: $0.9 \text{ pu} \leq U \leq 1.1 \text{ pu}$; and
- Frequency range: $49.9 \text{ Hz} \leq f \leq 50.05 \text{ Hz}$
- Minimum observation time: $T_{\text{obs}} = 30 \text{ s} + P_{\text{ref}}/P_{\text{Cmax}} \cdot 300 \text{ s}$
 - P_{ref} - Unit rated power;
 - P_{Cmax} - Maximum power for type C
- Maximum gradient of active power increase $\leq 20\%$ of P_{max/min}

Due to congestion in the transmission network, outage of the transmission line or some other element of the system, possible ongoing process of black start, reconnection for PGM's type D without the permission of the dispatcher shall be forbidden.

Non-exhaustive Requirement	Conditions for automatic reconnection
Articles 14(4)(b)	<p>4. Type B power-generating modules shall fulfil the following requirements relating to system restoration:</p> <p>(b) installation of automatic reconnection systems shall be subject both to prior authorization by the relevant system operator and to the reconnection conditions specified by the relevant TSO.</p>
Applicability:	Type B, C and D
Mandatory	
General	
ENTSO-E Practice	Mostly same like "manually" reconnection (14(4)(a) or not allowed.

Difference between reconnection 14(4)(a) and 14(4)(a) is that first one is related to manual reconnection and second one is related to automatic reconnection. Recommended conditions are the same for both types of reconnection.

2.4.2. Blackstart Capability

Non-exhaustive Requirement	Technical specifications for a quotation for black start capability
Articles 15(5)(a)(ii)	<p>5. Type C power-generating modules shall fulfil the following requirements relating to system restoration:</p> <p>(a)with regard to black start capability:</p> <p>(ii)power-generating facility owners shall, at the request of the relevant TSO, provide a quotation for providing black start capability. The relevant TSO may make such a request if it considers system security to be at risk due to a lack of black start capability in its control area;</p>
Applicability:	Type C and D
Non - Mandatory	
General	
ENTSO-E Practice	Mostly undefined
<p>Technical specifications that shall be cover with quotation for black start capability:</p> <ul style="list-style-type: none"> • capability of starting from shutdown without any external electrical energy supply, • capability of starting from shutdown to idle mode in 10 minutes • capability to synchronize on a system whose voltage is equal to zero, • capability to operate in speed control mode after synchronization, • capability to operate in speed control mode within extended frequency and voltage ranges, • capability of parallel operation of a few power-generating modules within one island (manually switch load and speed control mode), • control voltage automatically during the system restoration phase, • wider range of generators voltage setpoint, 0.9-1.05 Un, and • maximum idle duration 	
Non-exhaustive Requirement	Timeframe within which the PGM is capable of starting from shutdown without any external electrical energy supply
Articles 15(5)(a)(iii)	<p>5. Type C power-generating modules shall fulfil the following requirements relating to system restoration:</p> <p>(a)with regard to black start capability:</p> <p>(iii)a power-generating module with black start capability shall be capable of starting from shutdown without any external electrical energy supply within a time frame specified by the relevant system operator in coordination with the relevant TSO;</p>
Applicability:	Type C and D
Non - Mandatory	
General	
ENTSO-E Practice	30, 15, 60 minutes

Based upon the operational practice in South East Europe, starting time of typical HPP unit from shutdown without any external electrical energy supply to idle mode is less than 10 minutes.

When defining a time frame, it is necessary to consider:

- Required time for manipulations in the internal network of the power plant (about 30 seconds)
- Start time of diesel generator or some other independent source (less than 3 minutes)
- Turbine start-up from zero to idle speed (less than 5 minutes)

Non-exhaustive Requirement	Voltage limits for synchronization when article 16.2 does not apply
Articles 15(5)(a)(iv)	<p>5. <i>Type C power-generating modules shall fulfil the following requirements relating to system restoration:</i></p> <p>(a) <i>with regard to black start capability:</i></p> <p>(iv) <i>a power-generating module with black start capability shall be able to synchronise within the frequency limits laid down in point (a) of Article 13(1) and, where applicable, voltage limits specified by the relevant system operator or in Article 16(2);</i></p>
Applicability:	Type C and D
Non - Mandatory	
General	
ENTSO-E Practice	+10%U _c 132 kV (reference voltage: 123 kV): 105-142 kV, 220 kV: 186-252 kV, 400 kV: 340-440 kV

During restoration process, network is quite underutilized and it is expected that overvoltages will occur. In practice, during restoration process, the situation with overvoltages in the network should be resolved by extending the possibilities to control voltage on generator terminal from standard range $\pm 5\%$, to extended range of $-10\%/+5\%$. This should correspond to extended range on transmission side. It is recommended to specify extended voltage limits for modules with black start capabilities to $-15\%/+10\%$ of rated voltage.

2.4.3. Capability of Island Operation

Non-exhaustive Requirement	Capability of island operation
Articles 15(5)(b)	<p><i>(b)with regard to the capability to take part in island operation:</i></p> <p><i>(i)power-generating modules shall be capable of taking part in island operation if required by the relevant system operator in coordination with the relevant TSO and:</i></p> <ul style="list-style-type: none"> • the frequency limits for island operation shall be those established in accordance with point (a) of Article 13(1), • the voltage limits for island operation shall be those established in accordance with Article 15(3) or Article 16(2), where applicable; <p><i>(ii)power-generating modules shall be able to operate in FSM during island operation, as specified in point (d) of paragraph 2. In the event of a power surplus, power-generating modules shall be capable of reducing the active power output from a previous operating point to any new operating point within the P-Q capability diagram. In that regard, the power-generating module shall be capable of reducing active power output as much as inherently technically feasible, but to at least 55 % of its maximum capacity;</i></p> <p><i>(iii)the method for detecting a change from interconnected system operation to island operation shall be agreed between the power-generating facility owner and the relevant system operator in coordination with the relevant TSO. The agreed method of detection must not rely solely on the system operator's switchgear position signals;</i></p> <p><i>(iv)power-generating modules shall be able to operate in LFSM-O</i></p>
Applicability:	Type C and D
Non - Mandatory	
Site specific	
ENTSO-E Practice	Undefined

Considering that this is a site-specific requirement, TSO should perform necessary simulations to decide about the suitable method for detecting a change from interconnected system operation to island operation in case of possibility that observed PGM could separate from the main network. This method of detection needs to consider system operator's switchgear position signals, rate of change of frequency, system frequency and control performance of turbine-governors in island mode of operation.

Non-exhaustive Requirement	Definition of quality of supply parameters
Articles 15(5)(b)(i)	<p><i>(b) with regard to the capability to take part in island operation:</i></p> <p><i>(i) power-generating modules shall be capable of taking part in island operation if required by the relevant system operator in coordination with the relevant TSO and:</i></p> <p><i>-the frequency limits for island operation shall be those established in accordance with point (a) of Article 13(1),</i></p> <p><i>-the voltage limits for island operation shall be those established in accordance with Article 15(3) or Article 16(2), where applicable;</i></p>
Applicability:	Type C and D
Non - Mandatory	
Site specific	
ENTSO-E Practice	Undefined

Voltage and frequency limits shall be within standard defined ranges.

Non-exhaustive Requirement	Methods and criteria for detecting island operation
Articles 15(5)(b)(iii)	<p><i>(b)with regard to the capability to take part in island operation:</i></p> <p><i>(iii)the method for detecting a change from interconnected system operation to island operation shall be agreed between the power-generating facility owner and the relevant system operator in coordination with the relevant TSO. The agreed method of detection must not rely solely on the system operator's switchgear position signals.</i></p>
Applicability:	Type C and D
Non - Mandatory	
Site specific	
ENTSO-E Practice	Undefined

Recommendation is the same like condition for loss of mains (subchapter 2.2.2). Two out of three conditions should be fulfilled:

- RoCoF is above define value (+1.5 Hz/s, -2 Hz/s) in two algorithm cycle times;
- Turbine speed/frequency is above 2% of rated speed or speed/frequency is less than 2% of rated speed;
- At least one of switches which separates PGM from the transmission network is open

2.4.4. Operation following Tripping to Houseload

Non-exhaustive Requirement	Provision of quick re-synchronisation capability
Articles 15(5)(c)(i)	<i>(c)with regard to quick re-synchronisation capability: (i)in case of disconnection of the power-generating module from the network, the power-generating module shall be capable of quick re-synchronisation in line with the protection strategy agreed between the relevant system operator in coordination with the relevant TSO and the power generating facility;</i>
Applicability:	Type C and D
Non - Mandatory	
General	
ENTSO-E Practice	Undefined

HPP units have quick re-synchronisation capabilities, less than 10 minutes. Gas turbines have also fast re-synchronisation capabilities, less than 30 minutes. On the other hand, typical reaction time of dispatchers after significant system disturbances is in the range 30 - 60 minutes.

With regard to quick re-synchronisation capability, power-generating module shall be capable to re-synchronise within 30 minutes.

Non-exhaustive Requirement	Minimum operation time within which the PGM is capable of operating after tripping
Articles 15(5)(c)(iii)	<i>(iii)power-generating modules shall be capable of continuing operation following tripping to houseload, irrespective of any auxiliary connection to the external network. The minimum operation time shall be specified by the relevant system operator in coordination with the relevant TSO, taking into consideration the specific characteristics of prime mover technology.</i>
Applicability:	Type C and D
Mandatory	
General	
ENTSO-E Practice	0-12 hours

Based on operational practice, typical reaction time of dispatchers from National Control Center after significant disturbances in transmission system is in the range of 30 - 60 minutes, thus it is recommended that the minimum operation time of continuing operation following tripping to houseload should be 60 minutes.

2.4.5. Active Power Recovery SPGM

Non-exhaustive Requirement	Definition of the magnitude and time for active power recovery
Articles 17(3)	<i>3) With regard to robustness, type B synchronous power-generating modules shall be capable of providing post-fault active power recovery. The relevant TSO shall specify the magnitude and time for active power recovery.</i>
Applicability:	Type B, C and D
Mandatory	
General	
ENTSO-E Practice	85% - 90% Un 0.5 - 5 s the allowed deviation is 10-20% of pre-fault active power output

Following a fault clearance, SPGM of types B, C and D should recovery to at least 90% of pre-fault active power output within 5 seconds, providing that voltage is higher or equal than 0.9 pu.

2.4.6. Post Fault Active Power Recovery PPM

Non-exhaustive Requirement	Specification when the post- fault active power recovery begins Specification of the max. allowed time for active power recovery Specification of magnitude and accuracy for active power recovery
Articles 20(3)(a)	<i>3. Type B power park modules shall fulfil the following additional requirements in relation to robustness: (a)the relevant TSO shall specify the post-fault active power recovery that the power park module is capable of providing and shall specify: (i) when the post-fault active power recovery begins, based on a voltage criterion; (ii) a maximum allowed time for active power recovery; and (iii) a magnitude and accuracy for active power recovery</i>
Applicability:	Type B, C and D
Mandatory	
General	
ENTSO-E Practice	Specification when the post- fault active power recovery begins 85% - 90% Un Specification of the max. allowed time for active power recovery - 0.5 - 5 s (included in the text above) Specification of magnitude and accuracy for active power recovery - the allowed deviation is 5% of P value

According to [44], the following parameter values are recommended:

- the post-fault active power begins, at a voltage level of (80 - 90)% pre-fault voltage at connection point;
- the maximum allowed time for active power recovery depends even on the clearing time T_{clear} of the fault by means of protection devices action and consequently this time may change between 0,5s and 10s, whereby shorter clearing time corresponds to faster response capabilities.
- the magnitude for post-fault active power recovery depends on the time the fault is cleared and basically on the availability of the primary energy source. Therefore, the magnitude for active power recovery may be adopted on the level of (80 - 90) % of pre-fault active power;
- accuracy for active power recovery - 10% of pre-fault active power.

The post-fault active power recovery shall start as soon as voltage reaches 80% of pre-fault value at connection point, the maximum allowed time for active power recovery shall be 1 second, while the magnitude for post-fault active power recovery shall be adopted on the level of 80 % of pre-fault active power.

2.5. Instrumentation, Simulation Models and Protections Issues

2.5.1. Control and Protection Scheme and Settings

Non-exhaustive Requirement	Control schemes Settings of the control devices
Articles	<i>“(a) with regard to control schemes and settings:</i>
14.5(a):	<i>(i) the schemes and settings of the different control devices of the power-generating module that are necessary for transmission system stability and for taking emergency action shall be coordinated and agreed between the relevant TSO, the relevant system operator and the power-generating facility owner;</i> <i>(ii) any changes to the schemes and settings, mentioned in point (i), of the different control devices of the power generating module shall be coordinated and agreed between the relevant TSO, the relevant system operator and the power-generating facility owner, in particular if they apply in the circumstances referred to in point (i) of paragraph 5(a);”</i>
Applicability:	Type B, C and D PGMs
Mandatory	
Site specific	
Non-exhaustive Requirement	Electrical protection schemes Electrical protection settings
14.5(b):	<i>“(b) with regard to electrical protection schemes and settings:</i> <i>(i) the relevant system operator shall specify the schemes and settings necessary to protect the network, taking into account the characteristics of the power-generating module. The protection schemes needed for the power generating module and the network as well as the settings relevant to the power-generating module shall be coordinated and agreed between the relevant system operator and the power-generating facility owner. The protection schemes and settings for internal electrical faults must not jeopardise the performance of a power generating module, in line with the requirements set out in this Regulation;</i> <i>(ii) electrical protection of the power-generating module shall take precedence over operational controls, taking into account the security of the system and the health and safety of staff and of the public, as well as mitigating any damage to the power-generating module;</i> <i>(iii) protection schemes may cover the following aspects:</i> <ul style="list-style-type: none"><i>external and internal short circuit,</i><i>asymmetric load (negative phase sequence),</i><i>stator and rotor overload,</i><i>over-/underexcitation,</i><i>over-/undervoltage at the connection point,</i><i>over-/undervoltage at the alternator terminals,</i><i>inter-area oscillations,</i><i>inrush current,</i><i>asynchronous operation (pole slip),</i><i>protection against inadmissible shaft torsions (for example, subsynchronous resonance),</i><i>power-generating module line protection,</i><i>unit transformer protection,</i><i>back-up against protection and switchgear malfunction,</i><i>overfluxing (U/f),</i><i>inverse power,</i><i>rate of change of frequency, and</i><i>neutral voltage displacement.</i>

(iv) changes to the protection schemes needed for the power-generating module and the network and to the settings relevant to the power-generating module shall be agreed between the system operator and the power-generating facility owner, and agreement shall be reached before any changes are made;”

Applicability: Type B, C and D PGMs

Mandatory

Site specific

This is site specific requirement, and as such it should be defined by the RSO during the connection process in due time for plant design. Regarding the procedure that could be applied during the connection process, following is proposed. After the PGFO submits connection requirement, RSO shall define any relevant site specific requirement related to the control and protection scheme, as part of technical requirements for connection of power generating facility. After the completion of the design phase PGFO should, send protection function calculation/study to RSO for approval. The PGFO has to obtain RSO approval before the first powering of the facility, and to implement protection function settings agreed with RSO during this phase. PGFO shall also conduct relay equipment testing according to the newly adopted and implemented settings and submit results to the RSO. Described steps should be part of the connecting procedure, and are given here only as a recommendation.

It is also recommended to the RSOs to adopt documents regarding coordination of power generating facility protection functions and system protection functions (both transmission and distribution system). This document could be considered as technical standard applied by the RSO, and it could greatly help PGFO during the design phase and calculation of relevant protection function settings. It is recommended to use recognized international standards, practices and recommendation in the field, such as:

- IEEE Std. C37.101-2006: IEEE Guide for Generator Ground Protection
- IEEE Std C37.102-2006: IEEE Guide for AC Generator Protection
- IEEE Std C37.91-2008: IEEE Guide for Protective Relay Applications to Power Transformers
- IEEE Std C37.96-2012: IEEE Guide for AC Motor Protection
- IEEE Std C37.110-2007: IEEE Guide for the Application of Current Transformers Used for Protective Relaying Purposes
- IEEE Std C37.117-2007: IEEE Guide for the Applications of Protective Relays used for Abnormal Frequency Load Shedding and Restoration
- IEEE Std C37.119-2005: IEEE Guide for Breaker Failure Protection of Power Circuit Breaker
- IEEE Power & Energy Society: Power Plant and Transmission System Protection Coordination (A report to the Rotating Machinery Protection Subcommittee of the Power System Relay Committee of the IEEE Power Engineering Society Prepared by Working Group J3
- CIGRE - Working Group B5.19 (2010) Protection Relay Coordination

Similar has been done in North America after serious accidents (e.g. North American disturbance on August 14, 2003) in order to improve overall system reliability. Examples of such documents include:

- NERC. (2015). Considerations for Power Plant and Transmission System Protection Coordination Technical Reference Document - Revision 2
- NERC. (2010). Power Plant and Transmission System Protection Coordination

2.5.2. Instrumentation

Non-exhaustive Requirement	<p>Settings of the fault recording equipment</p> <p>Triggering criteria of the fault recording equipment</p> <p>Sampling rates of the fault recording equipment</p> <p>Specifications of the oscillation trigger</p> <p>Protocols for recorded data</p>
Articles 15(6)(b)(i-iv)	<p><i>(b) with regard to instrumentation:</i></p> <p><i>(i) power-generating facilities shall be equipped with a facility to provide fault recording and monitoring of dynamic system behaviour. This facility shall record the following parameters:</i></p> <ul style="list-style-type: none"> • <i>voltage,</i> • <i>active power,</i> • <i>reactive power, and</i> • <i>frequency.</i> <p><i>The relevant system operator shall have the right to specify quality of supply parameters to be complied with on condition that reasonable prior notice is given;</i></p> <p><i>(ii) the settings of the fault recording equipment, including triggering criteria and the sampling rates shall be agreed between the power-generating facility owner and the relevant system operator in coordination with the relevant TSO;</i></p> <p><i>(iii) the dynamic system behaviour monitoring shall include an oscillation trigger specified by the relevant system operator in coordination with the relevant TSO, with the purpose of detecting poorly damped power oscillations;</i></p> <p><i>(iv) the facilities for quality of supply and dynamic system behaviour monitoring shall include arrangements for the power-generating facility owner, and the relevant system operator and the relevant TSO to access the information. The communications protocols for recorded data shall be agreed between the power-generating facility owner, the relevant system operator and the relevant TSO;</i></p>
Applicability:	Type C and D PGMs

Non-mandatory/mandatory

Site specific

The instrumentation requirements are consisted from one non-mandatory and three mandatory requirements. All four requirements are site specific, which means that general values cannot be given, instead general methodology can be specified by the relevant system operator. Precise values should be given while issuing technical requirements for connection.

The Article 15(6)(b)(ii) of RfG as an exhaustive requirement defines that power-generating facilities have to be equipped *with a facility to provide fault recording and monitoring of dynamic system behaviour*. In practise, fault recording and monitoring of dynamic system behaviour as well as monitoring of power quality of supply are being done by the digital fault recorder (DFR). Hereinafter a term fault recorder will be used for referring to this equipment. The fault recorders shall at least record the following parameters:

- Voltage
- Active power
- Reactive power

- Frequency.

However, as non-mandatory requirement the same article defines that relevant system operator *has right to specify quality of supply parameters to be complied with on condition that reasonable prior notice is given*. Taking into account that this is a non-mandatory requirement it does not have to be implemented at national level. However, implementation of this requirement is necessary in the system with a big amount of PGMs connected via power electronics. In such system the maintenance of necessary level of the power quality is quite challenging. If there is a need for implementation of this non-mandatory requirements, it is recommended that quality of supply parameters being specified in accordance with an applicable international/national standard.

The second requirement is mandatory and it is stated in the Article 15(6)(b)(ii) of RfG. According to this article the relevant system operator and the power-generating facility owner should agree on the setting of the fault recording equipment, including triggering criteria and the sampling rates. The settings should be agreed in coordination with relevant TSO. As already mentioned, this is the site specific requirement and the settings of the fault recording equipment depend on a grid nominal voltage level, rated power of PGMs as well as type of the equipment which will be installed in the power-generating facility.

When defining the settings of the fault recording equipment it should bear in mind that data obtained from these recorders represents a starting point of any analysis aiming to investigate system disturbances. This also includes the analysis which investigate big disturbances such as an interconnection separation or the black out. Also, data from fault recorders give opportunity to the relevant TSO to analyse the system behaviour in critical states, e.g. for risk assessments, and to draw conclusions for possible improvements. Therefore, it is a crucial that the implemented settings are coordinated with the relevant TSO in order to ensure that the relevant TSO will receive all necessary data for carrying out the disturbance analyses.

With regard to triggering criteria, two recording triggering methods are commonly used:

- Events that the recorders determine from its input signals values
- Digital signals issued by the protection equipment.

Which method will be used depends on the parameters to be recorded as well as available digital signals from the protection equipment. The use of the first method is recommended, because by using this method, monitoring of relay equipment can be also done.

The sampling rate generally cannot be set, however, it can be demanded that digital fault recorder (DFR) to be installed in the power-generating facility have the sampling rate that is equal to or greater than some given threshold. Which threshold will be set depends on parameters to be recorded i.e. the number of the harmonic that should be obtained from parameters. It is clear that for the fast changing parameters the sampling rate should be as high as possible and for recording slow changing parameters the sampling rate can be considerably lower. Having in mind that parameters to be recorded have base frequency of 50 Hz and number of the harmonic that should be obtained for the most of above mentioned analysis is 8, the sampling rate should be at least 1 kHz.

Besides above mentioned settings, pre-trigger and post-trigger data length should be also agreed as well as the maximum number of the events to be recorded. This trigger data length or trigger time, depends on type of disturbance to be recorded. For instance, for recording short circuit the pre-trigger time should be up to 1 seconds, whereas the post-trigger time should be up to 30 seconds. On the other hand, for recording the power oscillations the post-trigger time have to be much longer (up to 30 minutes) whereas the pre-trigger time can be the same as for short circuit. Taking into account that majority of commercial DFR can record up to 100 events, the maximum number of the events to be recorded should be around 100.

The third requirement is also mandatory and it is stated in the Article 15(6)(iii) of RfG. According to this article the relevant system operator in coordination with the relevant TSO should specified an oscillations trigger to be used by the fault recorder in order to detect poorly damped power oscillations. This requirement is also site specific, as this trigger may be accomplished on several ways, depending on applied protection schemes and capability of the fault recorder which will be installed.

One way of triggering is using digital signal from the generator loss-of-synchronism/pole slip protection. If the loss-of-synchronism protection is not applied, then it should be checked, whether distant protection blocking during power oscillation is applied within distant relays and if so, whether the signal from the distant relays can be used as the trigger. At the end if there is no the distant protection blocking, the detection of the power oscillation must be implemented within the fault recorder. Some of commonly used methods should be applied such as the impedance based power swing detection or the voltage detection method, depending on which method can be realized within the fault recorder. It should be emphasized that settings of this functions are not trivial. For instance, one of the parameter that should be determined is frequency of the power oscillations. For determining this frequency a separate study should be performed. This could be done during the process of issuing technical conditions for connection.

The last requirement related to the instrumentation is also mandatory (Article 15(6)(iv) of the RfG) and it implies that a communication protocol for exchanging recorded data should be agreed between the PGFO, the RSO and the relevant TSO. The use of the same communication protocol as for exchanging other information (measurements etc.) is recommended. It is also recommended that the power-generating facility owner exchange data only with one system operator (RSO or TSO) which then forwards data to other system operator (RSO or TSO). The commonly used protocols are IEC 60870-5-101 and IEC 60870-5-104.

2.5.3. Simulation models

Non-exhaustive Requirement	Provision of simulation models
	Specifications of the simulation models
	Recordings of PGM performance
Article 15.6(c):	<p><i>“c) with regard to the simulation models:</i></p> <p>(i) <i>at the request of the relevant system operator or the relevant TSO, the power-generating facility owner shall provide simulation models which properly reflect the behaviour of the power-generating module in both steady-state and dynamic simulations (50 Hz component) or in electromagnetic transient simulations.</i></p> <p><i>The power-generating facility owner shall ensure that the models provided have been verified against the results of compliance tests referred to in Chapters 2, 3 and 4 of Title IV, and shall notify the results of the verification to the relevant system operator or relevant TSO. Member States may require that such verification be carried out by an authorised certifier;</i></p> <p>(ii) <i>the models provided by the power-generating facility owner shall contain the following sub-models, depending on the existence of the individual components:</i></p> <ul style="list-style-type: none"> • alternator and prime mover, • speed and power control, • voltage control, including, if applicable, power system stabiliser ('PSS') function and excitation control system, • power-generating module protection models, as agreed between the relevant system operator and the power-generating facility owner, and • converter models for power park modules; <p>(iii) <i>the request by the relevant system operator referred to in point (i) shall be coordinated with the relevant TSO. It shall include:</i></p> <ul style="list-style-type: none"> • - the format in which models are to be provided,

- - the provision of documentation on a model's structure and block diagrams,
 - - an estimate of the minimum and maximum short circuit capacity at the connection point, expressed in MVA, as an equivalent of the network;
- (iv) *the power-generating facility owner shall provide recordings of the power-generating module's performance to the relevant system operator or relevant TSO if requested. The relevant system operator or relevant TSO may make such a request, in order to compare the response of the models with those recordings;”*

Applicability: Type C and D PGMs

Non-mandatory

ENTSO-E Practice Generally required but specification itself is mostly treated as site specific

Even though it is not mandatory, it is highly recommended to implement this requirement, i.e. to make it mandatory at national level. Models for steady state and dynamic analysis (50 Hz) should be required at least. From the operator’s standpoint having validated user’s facility model enables him to adequately model it’s response to various operating conditions. These models could be, and should be, used for compliance tests where direct/physical test are not possible, to perform analysis in order to determine user’s influence on the system, and also for operation and planning of the network purposes. Detailed and verified models will also enable RSO to determine parameters for user’s equipment and control systems of interest (e.g. PSS settings), prior to its connection, or to adopt new parameter values if the analysis show that such modification is needed. Detailed analysis are also crucial for holistic approach described in [17].

Regarding model formats and structure coordination between TSOs at regional level can facilitate creation of regional models, needed when conducting region level analysis. From the national viewpoint cooperation and coordination between TSO and DSO is crucial in order that models used for transmission and distribution system modeling are compatible. For the format itself RSO should specify file formats accepted by the software tool that it uses (e.g. DigSILENT PowerFactory, PSS®E etc.). During the implementation of this requirement RSO should define unambiguously all of the accuracy requirements and criteria related to the validation of the models provided by the PGFO.

When defining structure of the models it is good practice to use models and practices defined in international standards whenever possible. Relevant standards for modelling power generating facilities include:

- IEEE Std 1110-2019: IEEE Guide for Synchronous Generator Modeling Practices and Parameter Verification with Applications in Power System Stability Analyses
- IEEE Std 421.5-2016: IEEE Recommended Practice for Excitation System Models for Power System Stability Studies
- IEEE Std 421.2-2014: IEEE Guide for Identification, Testing, and Evaluation of the Dynamic Performance of Excitation Control Systems
- IEEE Power & Energy Society: Dynamic Models for Turbine-Governors in Power System Studies
- IEC 61400-21: Wind Turbines - Part 21: Measurement and assessment of power quality characteristics of grid connected wind turbines.
- IEC 61400-27-2: Wind Turbines - Part 27-2: Electrical simulation models - Model validation

When implementing this requirement at national level it is strongly recommended that TSO and DSO define this requirement as detailed as possible in order to avoid misinterpretation of some of the requirements. An example of such detailed definition can be found in [28].

2.5.4. Information exchange

Non-exhaustive Requirement	Content of information exchange
	Precise list of data to be facilitated
	Precise time of data to be facilitated
Article 14(5)(d)(i)(ii)	<p><i>(d) with regard to information exchange:</i></p> <p><i>(i) power-generating facilities shall be capable of exchanging information with the relevant system operator or the relevant TSO in real time or periodically with time stamping, as specified by the relevant system operator or the relevant TSO;</i></p> <p><i>(ii) the relevant system operator, in coordination with the relevant TSO, shall specify the content of information exchanges including a precise list of data to be provided by the power-generating facility.</i></p>
Applicability:	Type B,C and D PGMs
Mandatory	
Site specific	

Within this requirement, the RSO in coordination with relevant TSO, has to specify the content of information exchange including a precise list of data and the time periods on which the information will be exchanged with PGMs. This is the mandatory requirement, which means that it has to be implemented at national level. This requirement aims at providing necessary data to the system operators which will allow them to operate system securely and efficiently, and maintain system stability and security of supply. In order to do so, the system operators must have a constant overview of the system states which also includes information related to the PGMs. It should be underlined that information exchange also implies the capability of the power-generating facilities to communicate in real time with the system operators in a secure manner.

The precise list of information and data to be exchanged, depends on the operational strategies specified by the relevant system operator and the relevant TSO. However, having in mind that sooner or later each of the beneficiary countries will have to adopt the SO GL¹⁴, it is strongly recommended that the requirements related to information exchange are defined in accordance with the Articles 41 - 53 of the SO GL. According to these articles information to be exchanged are divided into three groups, depending on the frequency of the information exchanges:

- Structural data
- Scheduled data
- Real time data

The list of the structural, scheduled and real time data to be exchanged between TSO and PGMs connected to the transmission system are given in the Chapter 4 of the SO GL, whereas the list of this data to be exchanged between TSO, DSO and PGMs connected to the distribution network is given in the Chapter 5 of the SO GL. It should be emphasized, that regarding communication, it is recommended that information exchange should be organised in such a way that the PGMs exchange information only with one system operator. This means that PGMs connected to the distribution network should exchange information with the particular DSO which will further forward information to the relevant TSO. Previously refers primarily to the real time data, whereas the structural and scheduled data can be exchanged separately if otherwise is not possible or if the current operational strategies define so. With such organization of data exchanges, a transfer of confidential data through the unsecured networks will be avoided or minimized.

¹⁴ Commission Regulation (EU) 2017/1485 of 2 August 2017, establishing a guideline on electricity transmission system operation (https://www.entsoe.eu/network_codes/sys-ops/)

With regard to the time stamping, the structural data should be provided during issuing the technical conditions for the connection. Besides, the structural data should be updated as soon as possible in the case of any changes. Some periodical update of the structural data can be also demanded by the RSO, for instance once per year. The scheduled data should be provided through the intraday and dayahead market processes. A time frame for providing this data, depends on adopted operational procedure for the intraday and dayahead which should be given in the market rules. The real time data, as the name suggests, should be exchanged in real time with the update interval of at least 60 s or more frequently for the measurements, whereas commands should be transferred as fast as possible i.e. with delay which is less than 10 s. Communication protocol that should be used for real time data exchange depends on current practice. The recommendation of the Consultants is the use some of the following protocols: IEC60870-6(ICCP/TASE.2), IEC 60870-5-104 and IEC 60870-5-101. All these protocols support the time stamping.

2.5.5. Disconnection from grid caused by angular instability or loss of control

Non-exhaustive Requirement	Criteria to detect loss of angular stability or loss of control
Article 15.6(a):	<i>“(a) with regard to loss of angular stability or loss of control, a power-generating module shall be capable of disconnecting automatically from the network in order to help preserve system security or to prevent damage to the power-generating module. The power-generating facility owner and the relevant system operator in coordination with the relevant TSO shall agree on the criteria for detecting loss of angular stability or loss of control;”</i>
Applicability:	Type C and D PGMs
Mandatory	
Site specific	
Dependencies:	Control and Protection Scheme and Settings

This is site specific requirement, and as such it should be defined by the RSO during the connection process in due time for plant design. This requirement is closely related to requirement on protection scheme and settings. Adequate protection function will depend on considered fault scenarios. For example in the case of loss of angular stability pole slip protection/out of step protection could be used. In the case of faults in turbine regulator anti-motoring/reverse power protection should be used. For faults in excitation system loss-of-field (LOF) protection should be used. Scope of protection functions and their settings should be coordinated/agreed between RSO and PGFO, according to the procedure for protection equipment scheme and settings, based on calculations and if possible simulations for relevant fault scenarios.

2.5.6. Additional devices to be installed in power generating facility in order to preserve or restore system operation or security

Non-exhaustive Requirement	Definitions of the devices needed for system operation and system security
Articles 15.6(d):	<i>“(d) with regard to the installation of devices for system operation and devices for system security, if the relevant system operator or the relevant TSO considers that it is necessary to install additional devices in a power-generating facility in order to preserve or restore system operation or security, the relevant system operator or relevant TSO and the power-generating facility owner shall investigate that matter and agree on an appropriate solution;”</i>
Applicability:	Type C and D PGMs

Mandatory

Site specific

Dependencies: Control and Protection Scheme and Settings.

This is site specific requirement, and as such it should be defined by the RSO during the connection process in due time for plant design. This requirement is closely related to requirements on control and protection scheme and settings.

2.5.7. Step up transformer HV side neutral point earthing type

Non-exhaustive Requirement Neutral point earthing

Article 15.6(f): *“f) earthing arrangement of the neutral-point at the network side of step-up transformers shall comply with the specifications of the relevant system operator.”*

Applicability: Type C and D PGMs

Mandatory

Site specific

Regarding earthing arrangements no special methodology is necessary. TSO and DSO should continue according to existing practice. One thing that should however be consider is clear definition whether it is expected from step up transformer with HV winding neutral directly earthed to have the ability to operate with isolated neutral point (for example If connection scheme calls for installation of disconnector in the HV side neutral). This should be clearly defined in due time for plant design as it will have impact on insulation requirements for step up transformer winding, and in return to transformer price.

2.5.8. Synchronization device

Non-exhaustive Requirement	Settings of the synchronisation devices
Article 16.4(d):	<p><i>“(d) the relevant system operator and the power-generating facility owner shall agree on the settings of synchronisation devices to be concluded prior to operation of the power-generating module. This agreement shall cover:</i></p> <ul style="list-style-type: none"> <i>(i) voltage;</i> <i>(ii) frequency;</i> <i>(iii) phase angle range;</i> <i>(iv) phase sequence;</i> <i>(v) deviation of voltage and frequency.”</i>
Applicability:	Type D PGMs
Mandatory	
Site specific	

This requirement is site specific requirement, and PGFO and RSO should agree on synchronization device parameters. Out of phase synchronization can lead to electrical and mechanical transients that could possibly damage the generator, prime mover, unit step up transformer, and also create power system perturbations. Besides the moment of out of phase synchronization, severity of this transients will depend on strength of the network at the connection point. When defining this requirement typical generating unit’s equipment capabilities should be also considered. Equipment is designed and produced to withstand out of phase synchronization up to certain degree, and it is usual that the synchronization (i.e. circuit breaker closing) is performed when the generator voltage is slightly leading and is slightly higher than the network voltage, in order to produce initial active and reactive power flow out of the generator in order to avoid anti-motor regime protection trip. According to the IEEE Std C50.12¹⁵ and IEEE Std C50.13¹⁶ *“generators shall be fit for service without inspection or repair after synchronizing”* within the following limits:

Breaker closing difference i.e. phase difference	±10%
Generator side voltage relative to system i.e. voltage difference	0% ÷ 5%
Frequency difference	±0.067Hz

This requirement should be agreed upon in due time for plant design, as it is the case for all other site specific requirements.

¹⁵ IEEE Standard for Salient-Pole 50 Hz and 60 Hz Synchronous Generators and Generator/Motors for Hydraulic Turbine Applications Rated 5 MVA and Above

¹⁶ IEEE Standard for Cylindrical-Rotor 50 Hz and 60 Hz Synchronous Generators Rated 10 MVA and Above

2.5.9. Angular stability

Non-exhaustive Requirement	Agreement for angular stability aid
Article 19.3:	<i>“3. The relevant TSO and the power-generating facility owner shall enter into an agreement regarding technical capabilities of the power-generating module to aid angular stability under fault conditions.”</i>
Applicability:	Type D PGMs
Mandatory	
Site specific	
Dependencies:	Voltage control

This is site specific requirement, and as such it should be defined by the TSO during the connection process in due time for plant design. This requirement is closely related to requirements on voltage control (i.e. implementation and settings of AVR’s PSS function).

2.5.10. Synthetic inertia

Non-exhaustive Requirement	Definition of the operating principle of control systems to provide synthetic inertia Related performance parameters to provide synthetic inertia
Article 21.2:	<i>“(a) The relevant TSO shall have the right to specify that power park modules be capable of providing synthetic inertia during very fast frequency deviations;” “(b) The operating principle of control systems installed to provide synthetic inertia and the associated performance parameters shall be specified by the relevant TSO”</i>
Applicability:	Type C and D PPMs
Non-mandatory	
General	
Dependencies:	RoCoF

As defined in RfG synthetic inertia is “facility provided by the power park module or HVDC system to replace effects of inertia of a synchronous power-generating module to a prescribed level of performance”. As it will be shown, this is fairly broad definition. In general inertial response of SPGM, can be described as contribution in form $\Delta P \sim df/dt$, but there is more to it. The response of SPGM to frequency change is defined by swing equation which is in per unit system given in a form of:

$$\Delta P = -\frac{2H}{f_n} \frac{df}{dt}$$

or in Laplace domain

$$\Delta P(s) = -\frac{2H}{f_n} s f(s)$$

where s is the Laplace operator. From this equations it is clear that beside the fact that ΔP amplitude is proportional to change in frequency, the phase between change in power ΔP and frequency f is 90° . Whether or not response from PE interfaced facility will implement both of before-mentioned characteristic will depend on form of implemented converter control system operating principle. Therefore it is common to described PEIPS response that possess both phase and amplitude

characteristic identical to SPGM as True Inertia (TI), and if the response poses only amplitude characteristic to call it Synthetic Inertia (SI). As defined in RfG, converter control system operating principle should be defined by the TSO. But this is no easy task nor the one that could be *ad-hoc* tackled.

Two commonly implemented control system operating principles are Virtual Synchronous Machine (VSM) and Direct Quadrature Current Injection (DQCI) converters with Swing Equation Based Inertial Response (SEBIR). As described in [17] VSM control systems are capable of providing TI response, while SEBIR control system provide SI which is not equivalent to SPGM's inertial response. The difference arises from implementation differences.

Even though DQCI inverters are usually called Voltage Source Converter (VSC) the name applies to the topology of the PE device and not the source itself. VSC are using self-commutating devices (such as IGBTs and MOSFETs) operating from stable DC voltage source, thus the name voltage source converter. If the converter controller implements DQCI control then for the fundamental frequency of 50 Hz, the inverter is operating as a current source. The inverter is taking voltage and frequency measurements and implement current injection control (i.e. calculation of current components in d-q stationary or rotating reference frame) to achieve defined P and Q setpoint. Such converters are unable to provide unbalanced current to load, or provide sinks for voltage harmonics in order to improve quality of supply, and cannot be operated in islanded mode. This inverters can implement swing equation (SEBIR control), thus providing SI, i.e. ΔP response proportional to change in frequency. However in order to adequately measure change of frequency (or RoCoF) it is needed to implement windowed measurements, as well as filtering of measured values to reject noise. This windowed measurements and filtering leads to the time-delay in response. When large measurement window is applied the inertial response can be called Fast Frequency Response instead of SI. As defined in [17] the response of such system is in a form of:

$$\Delta P(s) = -R(s)F(s)M(s)\frac{2H}{f_n}sf(s)$$

where $M(s)$ is frequency characteristics of measurement scheme, $F(s)$ is the frequency characteristics of post measurement filtering, and $R(s)$ is the response characteristics of the controller. Because of the introduced delay, even as small as 20 ms or 40 ms (i.e. 1 to 2 fundamental frequency periods), the response from this kind of converters can be quite different from true inertial response. However lowering measurement windows to assess RoCoF can lead to converter controller instabilities, therefore practical implementations of this controllers require longer measurement windows and post measurement filtering in order to maintain controller stability. As indicated in the research papers even though this kind of control scheme delivers additional inertia, it can lead to the network destabilization and even cause super-synchronous instability (usually bandwidth of this kind of controllers is around 250 Hz). Amplitude and phase response of such systems compared to SPGM's inertial response are given in. As it can be seen phase response of this control systems is quite different from SPGM's. In case that the introduced time delays lead to phase difference of 180° compared to SPGM's, or other TI response, it can lead to SI response that is in anti-phase from SPGMs, leading to sub-synchronous oscillations, thus degrading network stability.

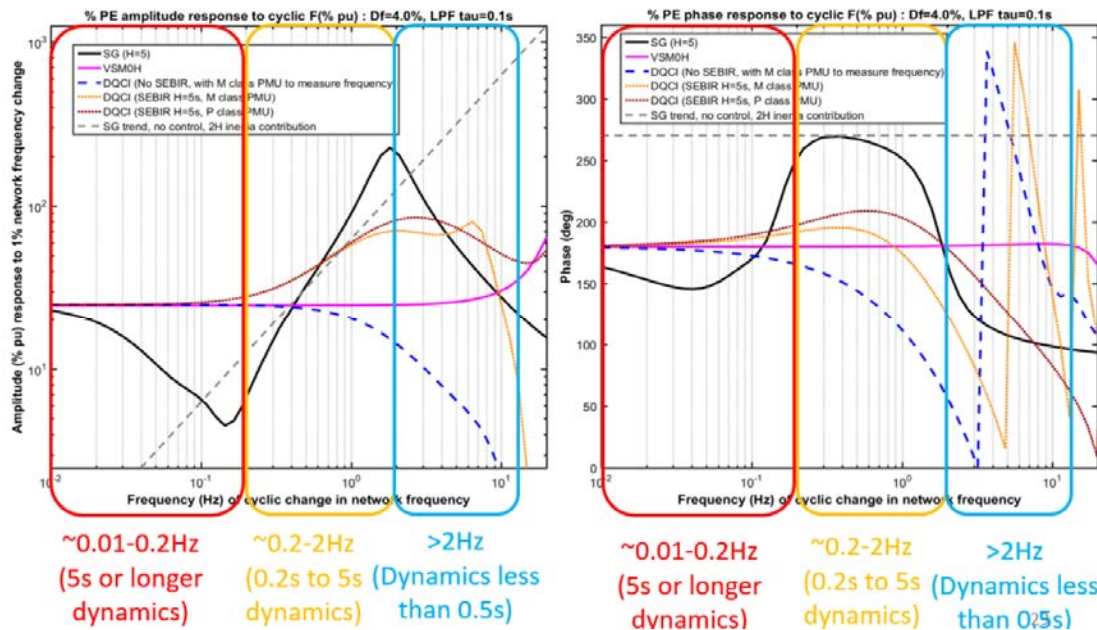

Figure 53 - Response of DQCI SEBIR controlled converters compared to SPGM's inertial response (Source: [17] Figure 2)

On the other hand using the same VSC converter topology with different control scheme (VSM) can give quite different response. In the case of VSM controllers, the controller calculates needed PWM pattern behind filter inductor installed between the switching bridge and the connection point, according to the following equation:

$$f(s) = -f_n \frac{\Delta P(s)}{2Hs}$$

where $\Delta P(s)$ is assessed over maximum 1 cycle period. This kind of control have direct analogy with SPGMs. Filter inductor can be consider equivalent to SPGM's transient reactance and the calculated PWM pattern is in fact calculated rotor voltage analogue to the EMF acting behind machine's transient inductance in the standard SPGM model. This kind of systems have bandwidth of order of magnitudes lower than fundamental frequency, usually below 5 Hz, and they act as true voltage sources. This kind of control provide both amplitude and phase inertial responses as the SPGMs, thus providing TI response. VSM control also allows the converter to be operated in islanded mode, to operate in PV mode, FV mode, and allows for both frequency droop settings and voltage control droop settings to be implemented. The response of VSM compared to SPGM is given in Figure 54. The difference in the amplitude response is due to the implemented critical damping in VSM (indicated in legend as Zeta 1), which is also responsible for slightly different phase response.

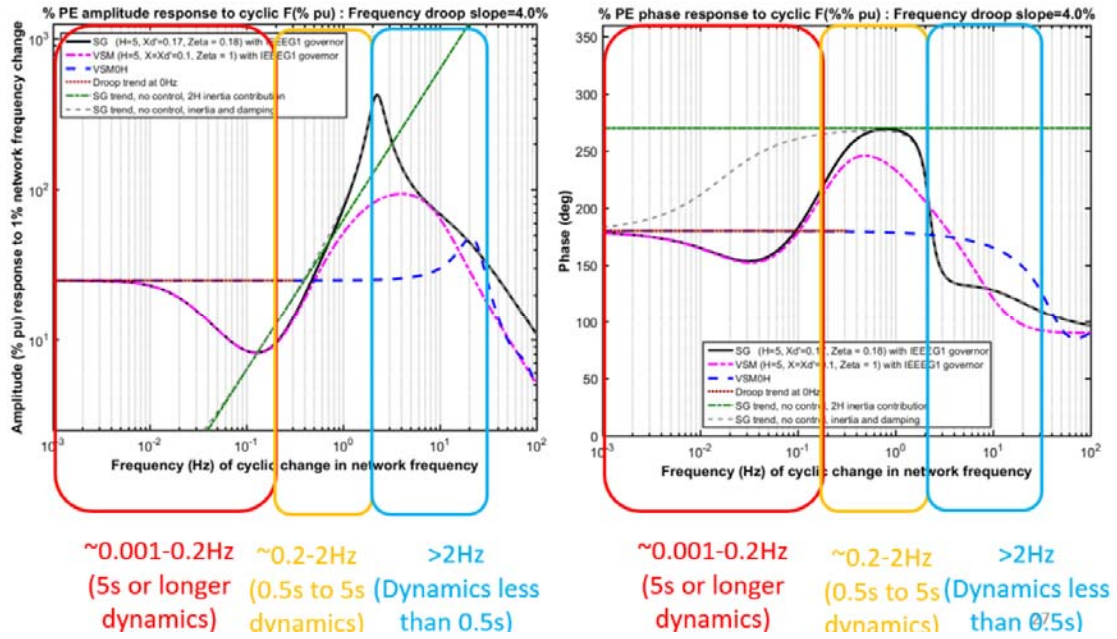

Figure 54 - Response of VSM controlled converters compared to SPGM's inertial response (Source: [17] Figure 1)

Total system inertia is very important factor, determining frequency stability of a system after sudden imbalance of production and consumption, e.g. in the case of large SPGM or demand trip. Value of TSI will determine initial RoCoF immediately after supply/demand imbalance, and it can be calculated as follows:

$$\left. \frac{df}{dt} \right|_{t=0^+} = \frac{-f_n P_k}{2 \sum_{i=1, i \neq k}^N H_i S_i}$$

where P_k is power of tripped generation, N is the number of SPGMs in the system, H_i and S_i are the inertial constant and installed capacity of the i^{th} SPGM, respectively. Starting point in time $t = 0$ correspond to the sudden generation/load imbalance, i.e. trip event. It is clear that when the overall TSI is lowered the initial RoCoF will increase. Main contributing factors for TSI reduction are RES penetration, i.e. RES substitution of SPGMs, which inherently contribute to system inertia, and SPGM decommissioning due to the environmental concerns. To be precise PE interfaced RES are the one having impact on TSI value, but because majority of RES is PE interfaced, except in the case of older WPP, small HPPs and biomass plants, it can be considered that amount of RES is almost equal to the amount of PE interfaced RES. TSOs should not allow that RoCoF value after disturbance exceeds user's capabilities (as requested by CNCs), that would lead to their trip.

As already mentioned depending on the implementation, some forms of control schemes contributing to ΔP response proportional to change in frequency, can be considered as fast frequency response instead of synthetic inertia. As stated in [18] this kind of response can help reducing frequency nadir after disturbance, and help in limiting its value above the first stage of frequency disconnection. Implementation of this kind of response is less challenging, and can be helpful especially in systems with high HPP contribution in overall production mix. HPPs operating in FSM immediately after the disturbance will have in phase response to frequency change (i.e. for frequency increase immediate output will also increase), which have negative effect on frequency stability. In this case fast frequency response from PEIPS in form of active power block infeed, instead of response proportional to frequency change, can help mitigate this problem, as stated in [18]. This strategy is within capabilities of existing PEIPS, and it was implemented and proven in practice, e.g. in Canada, as indicated in [18].

The effect of RES penetration on overall TSI and therefore frequency stability will depend on RES Load Penetration Index (RLPI). This index represent the maximum hourly amount of the load supplied by the RES (i.e. RLPI of 90% would indicate that 90% of load is supplied by the RES in critical hour). The averaged RES penetration is not good represent of critical scenario from the standpoint of operational security. As indicated in [17] the existing experiences (e.g. Denmark) indicate that the RLPI can be 4 to 5 times greater than the averaged RES penetration is.

The severity of TSI reduction will greatly depend on SA size and expected RES penetration, i.e. on RLPI target values. Having in mind that the scope of this project is limited to EnC countries, belonging to Continental Europe SA, and according to the current state as indicated in [17] and [19] major issues are not foreseen at the CE SA level. However, contribution to overall TSI from each country, and dependency of each country from the inertia somewhere else in the SA have to be considered, in order to prevent system collapse after SA split, if such event is to occur. In the case of the Balkan countries recent events from January the 8th, confirmed that such conclusion is valid, but this does not mean that in the future development plans TSOs shouldn't considered their system's inertia, and dependency of their system from rest of the SA regarding inertia and frequency stability.

One of the way in which TSI reduction problems can be mitigated is by introducing SI requirement for the newly connected PEIPS, as defined in RfG. However, this is not an easy request to define. The problem of overall TSI reduction can be managed in different ways. Traditionally this was achieved by limiting the amount of load supplied by RES at any given point. However, this can be costly and environmentally unacceptable, as indicated in the analysis performed for the SA faced with this problem (such is the case in Great Britain and Ireland with North Ireland). Another way in which this can be mitigated is with the use of synchronous compensators, which are essential synchronous machines with no prime movers. This solution can be acceptable in the case of countries faced with voltage control problems, but at the other hand this solution is more expensive than other solutions suitable for voltage/var control, such as static compensator devices. On the other hand introduction of SI can lead to adverse interaction with other employed remedial action schemes, and the effect will greatly depend on the synthetic inertia control scheme. Because of this it is highly recommended than holistic approach is implemented, meaning that the system as a whole is analyzed, assessing overall system inertia, expected maximum initial RoCoF, grid code defined RoCoF values and system strength when determining whether or not to introduce this requirement at national level. Also the effects of any synthetic inertia requirements on the system as whole must be analyzed, having in mind that the employed control scheme will influence beside frequency stability other aspects of system operation as indicated in [17]. This analysis should be done as part of transmission system development planning. Good flowchart regarding analysis whether or not to introduce this requirement at national level is given in [17] and here presented in Figure 55. Given year 2030. should be considered indicative. This year is calculated as: planned year of CNC entry into force (2016) + estimated time period for completion of new RES projects (4 years) + one half of expected lifetime of newly constructed RES (10 years).

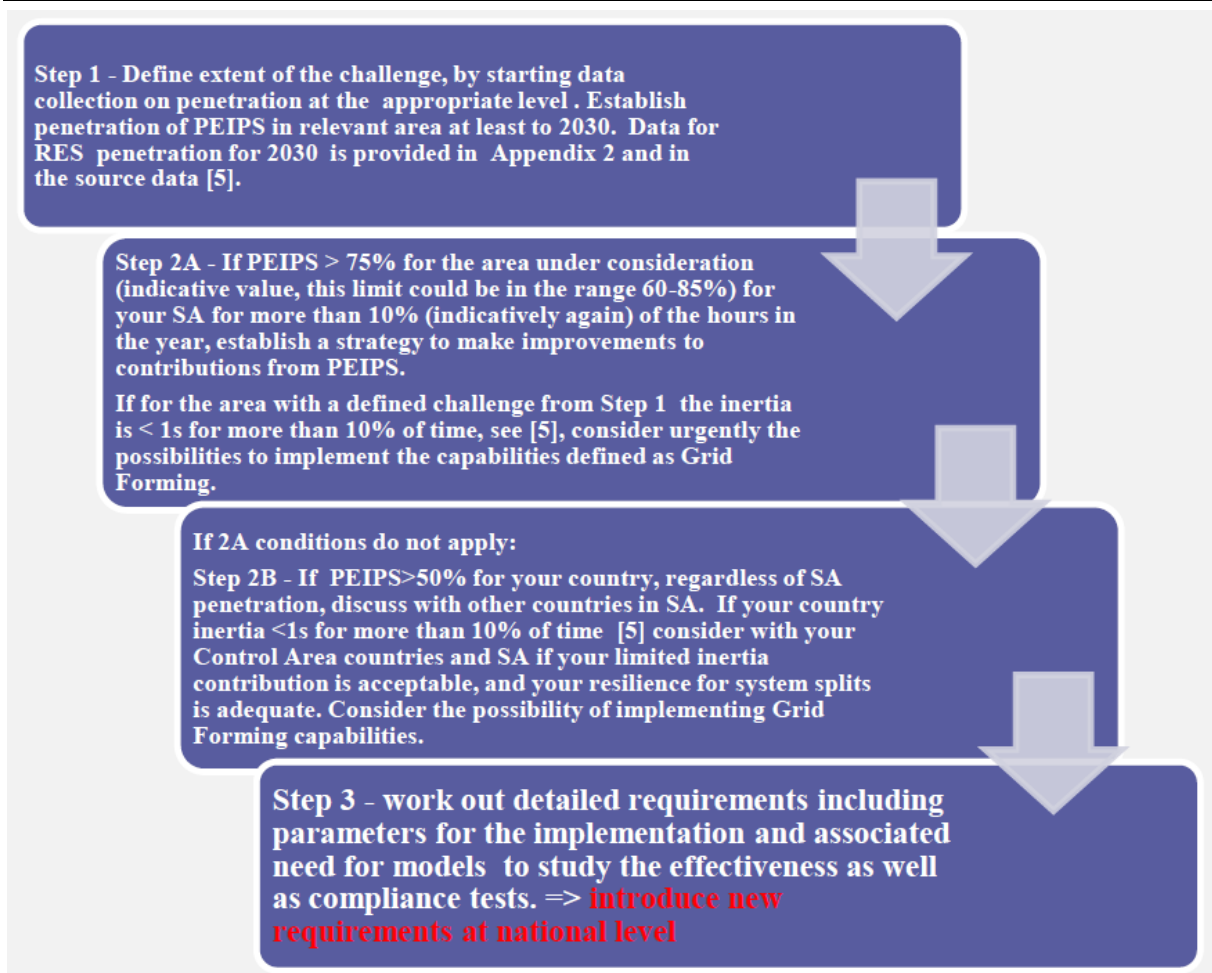

Figure 55 - Steps for implementing SI requirements at national level (data source: [17])

At the moment the recommendation is for the TSO's to perform proposed analysis regularly as part of transmission system development plans, and not to introduce this requirement at national level. As stated in the introductory statement of this report, non-mandatory RfG requirement can be implemented at national level at any given point if the need arise. This does not mean that the introduction of non-mandatory PEIPS related requirements should be unduly delayed. This can lead to more strict requirements that will be set upon future grid users once the requirements are introduced. This is why proposed analysis, including dynamic simulation should be regularly performed.

3. Methodology for DCC Non-Exhaustive Requirements

3.1. Frequency Issues

3.1.1. Frequency Ranges

Article 12(1)(2): *“(1) Transmission-connected demand facilities, transmission-connected distribution facilities and distribution systems shall be capable of remaining connected to the network and operating at the frequency ranges and time periods specified in Annex I.”*

“(2) The transmission-connected demand facility owner or the DSO may agree with the relevant TSO on wider frequency ranges or longer minimum times for operation. If wider frequency ranges or longer minimum times for operation are technically feasible, the consent of the transmission-connected demand facility owner or DSO shall not be unreasonably withheld.”

Applicability: TC DF and TC DS

Mandatory/non-mandatory (Article 12(2))

According to the Article 12(1) of DCC¹⁷, each TSO from beneficiary countries has to define time periods for which a transmission-connected demand facility (TC DF), a transmission-connected distribution facility or a distribution system (TC DS) has to be capable of operating on different frequencies, deviating from a nominal value, without disconnecting from the network as given in Table (Table 18)

Table 18 - Time periods for corresponding frequency ranges to be defined by TSOs

Synchronous area	Frequency range	Time period for operation
Continental Europe, Ukraine	47,5 Hz-48,5 Hz	To be specified by each TSO, but not less than 30 minutes
	48,5 Hz-49,0 Hz	To be specified by each TSO, but not less than the period for 47,5 Hz-48,5 Hz
	49,0 Hz-51,0 Hz	Unlimited
	51,0 Hz-51,5 Hz	30 minutes
Moldova	47,5 Hz-48,5 Hz	To be specified by each TSO, but not less than 30 minutes
	48,5 Hz-49,0 Hz	To be specified by each TSO, but not less than the period for 47,5 Hz-48,5 Hz
	49,0 Hz-51,0 Hz	Unlimited
	51,0 Hz-51,5 Hz	To be specified by each TSO, but not less than 30 minutes
Georgia	47,5 Hz-48,5 Hz	Not less than 30 minutes
	48,5 Hz-49,0 Hz	Not less than 60 minutes
	49,0 Hz-51,0 Hz	Unlimited
	51,0 Hz-51,5 Hz	Not less than 30 minutes

¹⁷ DCC refers to EU Regulation 2016/1388 of 17 August 2016 incorporated and adapted by PHLG decision 2018/05/PHLG-EnC of 12 January 2018

In both cases (under/over frequency), time periods for which TC DF and TC DS should stay connected depend on time periods that are defined for power generating modules. For the case of over-frequency (51.0 Hz - 51.5 Hz) time period should be defined in such a way that it is at least the same or longer than the time period defined for PGMs. The reason for this lies in the fact that in the situation of over-frequency there is a surplus of production in the system, which means that disconnection of demand before PGMs will only aggravate situation regarding over-frequency. Therefore, TC DF and TC DS should stay connected longer than PGMs in the situation of over-frequency.

In the case of under-frequency, there is a lack of production in the system, which means that TC DF and TC DS should be disconnected before disconnecting PGMs. Therefore, time periods for the case of under-frequency (47.5 Hz - 48.5 Hz and 48.5 Hz - 49.00 Hz) should be defined in such way that they are at least the same or shorter than time periods defined for PGMs.

With regard to wider frequency ranges or longer minimum times for operation, this non-mandatory requirement make sense to be implemented at national level if the same requirements defined for PGMs. If this is the case, then by the same principles as above described this requirement should be defined for TC DF and TC DS.

The wider frequency ranges or longer minimum times for operation could be also applied on the TC DF and TC DS which are envisaged to be included in black start operation plan. If simulation of the black start procedure shows that in any island frequency ranges or minimum operation times could be wider than frequency ranges given in Table 18, then this non-mandatory requirement should be implemented at national level.

3.1.2. Rate of Change of Frequency

Article 28(2)(k): *“(k) have the withstand capability to not disconnect from the system due to the rate-of-change-of-frequency up to a value specified by the relevant TSO. With regard to this withstand capability, the value of rate-of-change-of-frequency shall be calculated over a 500 ms time frame. For demand units connected at a voltage level below 110 kV, these specifications shall, prior to approval in accordance with Article 6, be subject to consultation with the relevant stakeholders in accordance with Article 9(1);”*

Applicability: TC DF and TC DS offering DR

Non-mandatory

According to the Article 28(2)(k) of DCC, the relevant TSO has to define the maximal rate of change of frequency for which the demand units with demand response active power control, demand response reactive power control, or demand response transmission constraint management have to be capable of remaining connected. It must be underlined that for the demand units connected at a voltage level below 110 kV, the rate of change of frequency should be defined in consultation with the relevant stakeholders in accordance with DCC Article 9(1). Therefore, after defining these parameters and before sending them for approval, the relevant TSO should organize consultation with the relevant stakeholders in order to consider their opinions.

According to the Article 28(1) of DCC, the DUs are not obligated to provide demand response (even if they are able to provide it), therefore, from that point of view, all requirements related to DR can be considered as non-mandatory. Nevertheless, it is suggested that requirements related to the DR should be defined at national level taking into account that maintenance of the system frequency at nominal value will become more challenging in the near future. In the countries in which currently there are DUs offering DR, these requirements have to be defined.

When defining rate of change of frequency (RoCoF) withstand capability, it should be considered that the demand units offering demand response have an important role in the system restoration. Therefore, it is very important that DUs offering DR should stay connected during emergency situation

in order to contribute to the system restoration process. This means, that RoCoF that DUs offering DR should be capable of withstanding, have to be the same as for power generating modules. Therefore, methodology given for PGMs can be also applied to DUs offering DR i.e. RoCoF calculated by that methodology should be also applied to DUs offering DR.

3.1.3. Demand Response System Frequency Control

Article 29(2)(c)(d)(e)(g): *“(c) be capable of operating across the normal operational voltage range of the system at the connection point, specified by the relevant system operator, if connected at a voltage level below 110 kV. This range shall take into account existing standards, and shall, prior to approval in accordance with Article 6, be subject to consultation with the relevant stakeholders in accordance with Article 9(1);”*

“(d) Be equipped with a control system that is insensitive within a dead band around the nominal system frequency of 50.00 Hz, of a width to be specified by the relevant TSO in consultation with the TSOs in the synchronous area. For demand units connected at a voltage level below 110 kV, these specifications shall, prior to approval in accordance with Article 6, be subject to consultation with the relevant stakeholders in accordance with Article 9(1);”

“(e) be capable of, upon return to frequency within the dead band specified in paragraph 2(d), initiating a random time delay of up to 5 minutes before resuming normal operation.

The maximum frequency deviation from nominal value of 50,00 Hz to respond to shall be specified by the relevant TSO in coordination with the TSOs in the synchronous area. For demand units connected at a voltage level below 110 kV, these specifications shall, prior to approval in accordance with Article 6, be subject to consultation with the relevant stakeholders in accordance with Article 9(1). The demand shall be increased or decreased for a system frequency above or below the dead band of nominal (50,00 Hz) respectively;”

“(g) be able to detect a change in system frequency of 0,01 Hz, in order to give overall linear proportional system response, with regard to the demand response system frequency control's sensitivity and accuracy of the frequency measurement and the consequent modification of the demand. The demand unit shall be capable of a rapid detection and response to changes in system frequency, to be specified by the relevant TSO in coordination with the TSOs in the synchronous area. An offset in the steady-state measurement of frequency shall be acceptable up to 0,05 Hz.”

Applicability: TC DUs offering DR SRC

Non-mandatory

In respect of demand units (DUs) with demand response system frequency control (DR SFC), the Article 29(2)(c)(d)(e)(g) of DCC defines that the relevant TSO in consultation with the TSOs in the synchronous area, should specify the following:

- The normal operational voltage range of the system at the connection point for DUs connected at a voltage level below 110 kV
- Width of dead-band around the nominal system frequency (50,00 Hz) of control system
- The maximum frequency deviation from nominal value of 50,00 Hz for which DUs should be providing the demand response
- Accuracy of frequency measurements and insensitivity of control system
- Initial time delay of active power response and time needed for the detection of frequency system changes

It must be underlined that for demand units connected at a voltage level below 110 kV, above mentioned parameters should be defined in consultation with the relevant stakeholders in accordance with DCC Article 9(1). Therefore, after defining these parameters and before sending them for approval, the relevant TSO should organize consultation with the relevant stakeholders in order to consider their opinions.

According to the Article 29(1) of DCC, the DUs are not obligated to provide demand response (even if they are able to provide it), therefore all requirements related to DR SFC are non-mandatory, and therefore, it is not required to be implemented at the national level. Nevertheless, taking into account that maintenance of the system frequency at nominal value will become more challenging in the future, the Consultants deem that requirements related to the DR SFC should be defined at national level. The Consultants also deem that requirements related to the DR have to be defined in the countries in which currently there are DUs offering DR. It should be emphasized that this methodology does not address questions neither arising from how the DU offering DR SFC should be included in the rules for ancillary services nor how relevant TSO should stimulate owners of DUs to provide DR SFC. For addressing the previous problems, it is recommended to conduct studies with aims of developing a reflective market which will stimulate providing of DR SFC, as well as to find the lowest cost market model to administrate and fairly recompense this service.

Having in mind that control systems for DR SFC are meant to be mass-produced, the normal operational voltage range of the system at the connection point for DUs connected at a voltage level below 110 kV should be defined in accordance with some of the applicable international standards. Taking into account that all beneficiary countries should follow European standards, it is recommended that this non-executive requirement to be defined in accordance with *EN 50160* standard. According to this standard, *during each period of one week 95% of the 10 min mean rms values of the supply voltage shall be within the range of $Un \pm 10\%$ and all 10 minutes mean rms values of the supply voltage shall be within the range of $Un +10\%/- 15\%$, under normal operating conditions.* It must be noted that this standard can be applied if DU is to be connected at a voltage level up to 35 kV (including 35 kV).

A conventional method used for the frequency containment and the restoration implies changing generation output in order to achieve the balance between the load and generation. However, as one more method for the frequency containment and restoration, demand response system frequency control could be used. Therefore, DUs offering DR SFC in order to contribute to frequency containment and restoration change their demands depending on frequency deviation. In other words, by using DR SFC it could be simulated FSM or/and LFSM or a combination of both.

Since DR SFC can be consider as a new service from DU and nether from beneficiary countries have experience with DR SFC introduction of this capability should be stepwise. This means that in the first phase necessary frequency parameters should be defined in such a way that DR SFC imitates LFSM-O and LFSM-U which are applied to generator units. Later, as operation experience rises, parameters could be reselected and frequency range could be narrowed in order to allow DR SFC to provide an earlier response and move it towards FSM. This reselection could be justified by the facts that it can be assumed that most of units which can provide DR SFC have replacement period of 10 years and that CNC implies parameters revision at 3 years. This means that for replacement of the most of these units it would be needed at least 10 years which will allow re-settings of the parameters at least 3-4 times without producing any additionally cost to the DU's owners.

By defining frequency related parameters it should be aware that these parameters have the system-wide effect. If the settings of this parameters are not harmonised within the synchronous area, that could produce an adverse effect in an emergency state of system. Namely, if each TSO has deferent settings of the dead-band of control system that will lead to deferent response between LFC blocks for the same deviation of frequency. The deferent response may result in unwanted load flow patterns which can aggravate already difficult situation in the system. Therefore, these parameters should be defined in strong collaboration between TSOs within a synchronous area and it is recommended that each TSO within the same synchronous area have the same settings of this parameters.

Having in mind above mentioned, dead-band of control system should be defined in such a way that DR SFC is activated at full deployment of FCR (frequency containment reserves). Taking into account

that in Continental Europe synchronous area (CE SA) FCR should be fully deployed for frequency deviation of ± 200 mHz, the dead-band of control system should be set in frequency range from 49.8 Hz to 50.2 Hz. By defining the dead-band in this way, overlapping or gap between fully deployments of FCR and activating of DR SFC, will be avoided.

The maximum frequency deviation non-exhaustive parameter implies defining two frequency thresholds, one for over-frequency and the other for under-frequency, for which full capability of DR SFC should be activated. These thresholds should be defined as follows.

If we divided loads at a non-essential and essential, the non-essential loads would be the ones not directly utilized by the final user. This means that electricity consuming and practice use of this type of loads are decoupled. On the other hand, essential loads represent loads which final user directly utilizes and they will notice any reduction of it. Accordingly, the DUs offering DR SFC represents the non-essential loads which means that it should be fully shaded before shedding of essential loads i.e. before LFDD (low frequency demand disconnection) is applied. Having in mind the previous and taking into account under-frequency thresholds for LFDD in the CE SA it is recommended that for under-frequency non-exhaustive maximum frequency deviation parameter value of 49.0 Hz should be set.

With regard to the over-frequency non-exhaustive maximum frequency deviation parameter, it should be set in such a way that in the conditions of over-frequency the maximum possible time for frequency restoration is given to the generation units. This means that DR FSC should contribute to frequency restoration until the maximum possible frequency is not reached in order to avoid unnecessary loss of generation. Therefore, it is recommended that value of 51.5 Hz should be set as the threshold for the over-frequency non-exhaustive maximum frequency deviation parameter.

The last four parameters which should be set at national level are accuracy of frequency measurements, insensitivity of control system, an initial time delay of active power response and time needed for detection of frequency system changes. In the Article 29(2)(g) of DCC is stated: *that DUs offering DR SFC should be able to detect a change in system frequency of 0,01 Hz, in order to give overall linear proportional system response, with regard to the demand response system frequency control's sensitivity and accuracy of the frequency measurement and the consequent modification of the demand.* This means that accuracy of frequency measurements has to be 0.01 Hz and that above mentioned frequency thresholds may be changed in steps of 0.01 Hz. This is an exhaustive parameter, therefore it has to be implemented as it is defined by DCC. However, DCC leaves room to the relevant TSO for defining the insensitivity of control system and the initial time delay. According to the same Article 29(2)(g) the insensitivity of control system shall be acceptable up to 0,05 Hz. When defining this parameter it should bear in mind that cost of the sensor of the system frequency is directly related with acceptable insensitivity of the control system. Therefore, insensitivity of control system should be set at maximum possible value in order to minimize cost of the sensor. If cost of the sensor is minimized, DUs offering DR SFC will be wide-spread across the system, which means that low sensitivity of the control system will be balanced out applying the rules of probability for a high number of units. With regard to initial delay, having in mind that most of the DUs offering DR SFC are controlled by the power electronics which are similarly to the one used for the PPMs or the photovoltaic panels, the initial delay should be equal or lower than maximum admissible initial delay for PGMs without inertia. Lastly, with regard to time needed for detection of frequency system changes, taking into account that the RoCoF has to be measured over a 500ms time period, the time needed for detection of frequency system changes should be up to 0.5s.

3.2. Voltage Issues

3.2.1. Voltage Ranges

Articles 13(1)(7):	<p><i>“1. Transmission-connected demand facilities, transmission-connected distribution facilities and transmission-connected distribution systems shall be capable of remaining connected to the network and operating at the voltage ranges and time periods specified in Annex II.”</i></p> <p><i>7. With regard to transmission-connected distribution systems with a voltage below 110 kV at the connection point, the relevant TSO shall specify the voltage range at the connection point that the distribution systems connected to that transmission system shall be designed to withstand. DSOs shall design the capability of their equipment, connected at the same voltage as the voltage of the connection point to the transmission system, to comply with this voltage range.”</i></p>
Applicability:	TC DF and TC DS
Mandatory	

The voltage ranges and time periods from the Annex II of the DCC are given in Tables (Table 19 and Table 20).

Table 19 - Minimum time periods during which the TC DF and TC DS must be capable of operating without disconnecting from the network, for grid of nominal voltage level from 110 kV to 300 kV

Synchronous area	Voltage range	Time period for operation
Continental Europe, Ukraine	0.9 pu - 1.118 pu	Unlimited
	1.118 pu - 1.15 pu	To be specified by each TSO, but not less than 20 minutes and not more than 60 minutes
Moldova	0.9 pu - 1.118 pu	Unlimited
	1.118 pu - 1.15 pu	20 minutes
Georgia	0.85 pu - 0.9 pu	30 minutes
	0.9 pu - 1.12 pu	Unlimited
	1.12 pu - 1.15 pu	20 minutes

Table 20 - Minimum time periods during which the TC DF and TC DS must be capable of operating without disconnecting from the network, for grid of nominal voltage level from 300 kV to 500 kV

Synchronous area	Voltage range	Time period for operation
Continental Europe, Ukraine	0.9 pu - 1.05 pu	Unlimited
	1.05 pu - 1.10 pu	To be specified by each TSO, but not less than 20 minutes and not more than 60 minutes
Moldova	0.9 pu - 1.097 pu	Unlimited
	1.097 pu - 1.15 pu	20 minutes
Georgia	0.85 pu - 0.9 pu	20 minutes
	0.9 pu - 1.10 pu	Unlimited
	1.10 pu - 1.15 pu	20 minutes

From the values given in tables shown above it is clear that the only non-exhaustive requirement that needs to be defined is the requested time period for operation in the case of highest voltages. The requested time period must be between 20 and 60 minutes. When defining this requirement, TSO should evaluate reaction time of dispatchers in order to perform adequate actions to bring back the voltages in normal operating range and the user's equipment capability to withstand higher voltage conditions. Considering that EnC member countries do not employ automatic secondary voltage control at the moment, the recommendation regarding this parameter is to request from user's equipment to be capable to operate with high voltages up to the upper permissible limit of 60 minutes. It should be pointed out that for Georgia and Moldova this requirement is exhaustive i.e. there is no specific value that should be defined.

With regard to transmission-connected distribution systems with a voltage below 110 kV at the connection point, the voltage range should be defined in accordance with some of the applicable international standards. Taking into account that all beneficiary countries should follow European standards, it is recommended that this non-executive requirement to be defined in accordance with EN 50160 standard. According to this standard, *during each period of one week 95% of the 10 min mean rms values of the supply voltage shall be within the range of $U_n \pm 10\%$ and all 10 minutes mean rms values of the supply voltage shall be within the range of $U_n +10\%/- 15\%$, under normal operating conditions.* It must be noted that this standard can be applied if DU is to be connected at a voltage level up to 35 kV (including 35 kV).

3.2.2. Automatic Disconnection Due to Voltage Level

Article 13(6): *“ 6. If required by the relevant TSO, a transmission-connected demand facility, a transmission-connected distribution facility, or a transmission-connected distribution system shall be capable of automatic disconnection at specified voltages. The terms and settings for automatic disconnection shall be agreed between the relevant TSO and the transmission-connected demand facility owner or the DSO.”*

Applicability: TC DF and TC DS

Non-mandatory

This site specific requirement should be defined by the relevant TSO during the connection phase of the TC DF or TC DS, but in due time for facility design, as it is the case for all the other site specific requirements. However, it should be emphasized that the specification of this requirement have to be coordinated with requirements for the LVDD schema and the voltage ranges. Therefore, the relevant TSO when defining the terms and settings for automatic disconnection should coordinate this parameter with LVDD schema if LVDD schema was implemented. Also, the TC DF and the TC DS should stay connected for time and voltage range corresponding to the national implementation of the requirement stated in the paragraph 1 of the Article 13. The main motivation for the relevant TSO to implement this requirement would be the existence of the TC DS or the TC DF connected via radial power line. If it is anticipated that the active power consumption of the radial connected TC DS or TC DF exceed voltage stability limits then this requirement should be implemented at national level.

3.2.3. Reactive power capability for TC DF and TC DS

Article 15: *“1. Transmission-connected demand facilities and transmission-connected distribution systems shall be capable of maintaining their steady-state operation at their connection point within a reactive power range specified by the relevant TSO, according to the following conditions:*

- (a) for transmission-connected demand facilities, the actual reactive power range specified by the relevant TSO for importing and exporting reactive power shall not be wider than 48 percent of the larger of the maximum import capacity or maximum export capacity (0,9 power factor import or export of active power), except in situations where either technical or financial system benefits are demonstrated, for transmission-connected demand facilities, by the transmission-connected demand facility owner and accepted by the relevant TSO;*
- (b) for transmission-connected distribution systems, the actual reactive power range specified by the relevant TSO for importing and exporting reactive power shall not be wider than:*
 - (i) 48 percent (i.e. 0,9 power factor) of the larger of the maximum import capability or maximum export capability during reactive power import (consumption); and*
 - (ii) 48 percent (i.e. 0,9 power factor) of the larger of the maximum import capability or maximum export capability during reactive power export (production);*

except in situations where either technical or financial system benefits are proved by the relevant TSO and the transmission-connected distribution system operator through joint analysis;

- (c) the relevant TSO and the transmission-connected distribution system operator shall agree on the scope of the analysis, which shall address the possible solutions, and determine the optimal solution for reactive power exchange between their systems, taking adequately into consideration the specific system characteristics, variable structure of power exchange, bidirectional flows and the reactive power capabilities in the distribution system;*
- (d) the relevant TSO may establish the use of metrics other than power factor in order to set out equivalent reactive power capability ranges;*
- (e) the reactive power range requirement values shall be met at the connection point;*
- (f) by way of derogation from point (e), where a connection point is shared between a power generating module and a demand facility, equivalent requirements shall be met at the point defined in relevant agreements or national law.”*

“2. The relevant TSO may require that transmission-connected distribution systems have the capability at the connection point to not export reactive power (at reference 1 pu voltage) at an active power flow of less than 25 % of the maximum import capability. Where applicable, Member States may require the relevant TSO to justify its request through a joint analysis with the transmission-connected distribution system operator. If this requirement is not justified based on the joint analysis, the relevant TSO and the transmission-connected distribution system operator shall agree on necessary requirements according to the outcomes of a joint analysis.”

“3. Without prejudice to point (b) of paragraph 1, the relevant TSO may require the transmission-connected distribution system to actively control the exchange

of reactive power at the connection point for the benefit of the entire system. The relevant TSO and the transmission-connected distribution system operator shall agree on a method to carry out this control, to ensure the justified level of security of supply for both parties. The justification shall include a roadmap in which the steps and the timeline for fulfilling the requirement are specified.”

“4. In accordance with paragraph 3, the transmission-connected distribution system operator may require the relevant TSO to consider its transmission-connected distribution system for reactive power management.”

Applicability: TC DF and TC DS

Mandatory/non-mandatory (15(1)(d),15(2),15(3))

DCC allows very broad possibilities for TSO and DSO collaboration in order to achieve efficient reactive power management. As stated in [25] DCC “prescribes the boundaries within which the TSO can set design limitations on reactive power exchanges” TC DF and TC DS. The prescribed maximal value of reactive power that can be requested to be supplied or consumed at TS/DS interface and TC DF connection point is 48% of larger of the maximum import capability or maximum export capability of the connected facility. This corresponds to a power factor value of 0.9, as minimum power factor value that can be requested, but higher values can be set in national implementation of CNC.

DCC provides wide array of possibilities regarding TSO/DSO collaboration. DCC covers only collaboration regarding connection framework and not reactive power management itself, as this should be implemented in operational network code. From ENTSO-E IGD [25] it seems that the main motivator behind this approach, was to define flexible framework that will allow sufficient and efficient TSO/DSO collaboration in order to overcome future challenges associated with transition from bulk generation connected to transmission system to distributed generation connected mainly to distribution system. This transition may lead to such problems as insufficient reactive power resources connected to transmission grid during periods of high RES production, geographical dislocation of RES reactive power resources from consumption, etc. However envisioned framework could, and should be utilized to tackle existing problems regarding reactive power management and voltage support. At the moment western Balkan countries are faced with high voltage levels at transmission network that are at times even beyond permissible ranges. In this situation possibility to use distribution network and TC DFs as reactive power sinks can be very valuable. Interconnecting transformers x/110 kV/kV with OLTC are already used in order to unload transmission grid from excessive reactive power in a way that will not negatively affect voltages at distribution network. Enforcing strict requirements regarding reactive power exchange at TS/DS interface, together with penalties, can have adverse effect. From financial standpoint penalties for excessive reactive power exchange will lead to decisions regarding investment in distribution local compensation devices in order to comply with set requirements that can have negative impact on currently used reactive power management schemes, which in fact utilizes distribution network as reactive power resource. Even justified from DSO’s standpoint, this investment is not in line with global optimal solution.

Regarding reactive power exchange at TS/DS interface, DCC defines that in order to find best solution for reactive power management TSO and DSO should conduct joint analysis. Scope of joint analysis should be defined during national implementation of CNC, and [25] proposes that such analysis should include at least:

- T-D interface voltage level, because it will determine the kind of technical solution that can be used at the interface;
- Interaction with power quality parameters;
- Strive for a global technical optimum at minimum cost;
- Avoiding cost shifts from one party to the other unless it is proven that this shift would contribute to the global techno-economical optimum;
- Overall cost of the chosen solution should be minimal for the system (distribution/transmission/users).

As starting point TSO and DSO should analyse reactive power needs of system under its control, and determine existing reactive power resources and its real capabilities. The analysis should be conducted for critical operating regimes, for existing and planned power system state, taking into consideration operational limitations. Next step would be to update existing TS/DS models and perform load flow analysis to determine is it possible to optimize utilization of existing resources (existing compensation devices/facilities, OLTC, reactive power loading of existing generators etc.) in order to achieve power factor at TS/DS interface at or above currently nationally implemented threshold. If this is not possible there are two additional analyses that should be performed. The first one would be determination of new projects and associated investment costs that would lead to existing prescribed value of power factor at TS/DS interface. The second one would be sensitivity analysis aimed towards lowering the value of required power factor at TS/DS interface and assessment of associated costs (both investment and variable costs from additional transmission/distribution active power losses). Considering results of the first and second analysis optimal solution can be found regarding required power factor at TS/DS interface that will include list of projects needed in order to achieve efficient reactive power management. Beside these analysis, analysis regarding dynamical reactive power reserve should be performed. If determined solution leads to generating modules that are operated on the very limit of underexcitation or overexcitation, this can have negative impact on dynamical voltage stability, because units operated at the very edge of their possibilities are not performing as P-U nodes but instead as P-Q nodes, which leads to fewer regulating nodes in the system.

As pointed out in [25] TSO and DSO can find added value in aggregation of connection points or grouping several connection points in a number of zones, and defining reactive power requirements for these zones. This should be done as a part of development of secondary voltage regulation scheme. A way to achieve efficient secondary voltage regulation system is by dividing system in zones that with nodes (both generating units and substation) that are electrically close. Determination of these zones will depend on system topology and characteristics.

These recommendations should provide sufficient guidelines but final set of analysis should be defined by the TSO and DSO in a way that will best fit each country. These analyses could be performed periodically (as a part of system development planning), and in a way that can promote closer collaboration between TSO/DSO regarding reactive power management.

3.2.4. Demand Response Service (DRS)

Article 28(2)(c)(e)(f)(i)(k)(l): *“2. Demand units with demand response active power control, demand response reactive power control, or demand response transmission constraint management shall comply with the following requirements, either individually or, where it is not part of a transmission-connected demand facility, collectively as part of demand aggregation through a third party:*

(c) be capable of operating across the normal operational voltage range of the system at the connection point, specified by the relevant system operator, if connected at a voltage level below 110 kV. This range shall take into account existing standards and shall, prior to approval in accordance with Article 6, be subject to consultation with the relevant stakeholders in accordance with Article 9(1);

(e) be equipped to receive instructions, directly or indirectly through a third party, from the relevant system operator or the relevant TSO to modify their demand and to transfer the necessary information. The relevant system operator shall make publicly available the technical specifications approved to enable this transfer of information. For demand units connected at a voltage level below 110 kV, these specifications shall, prior to approval in accordance with Article 6, be subject to consultation with the relevant stakeholders in accordance with Article 9(1);

(f) be capable of adjusting its power consumption within a time period specified by the relevant system operator or the relevant TSO. For demand units connected at a voltage level below 110 kV, these specifications shall, prior to approval in accordance with Article 6, be subject to consultation with the relevant stakeholders in accordance with Article 9(1);

(i) notify the relevant system operator or relevant TSO of the modification of demand response capacity. The relevant system operator or relevant TSO shall specify the modalities of the notification;

(k) have the withstand capability to not disconnect from the system due to the rate-of-change-of-frequency up to a value specified by the relevant TSO. With regard to this withstand capability, the value of rate-of-change-of-frequency shall be calculated over a 500 ms time frame. For demand units connected at a voltage level below 110 kV, these specifications shall, prior to approval in accordance with Article 6, be subject to consultation with the relevant stakeholders in accordance with Article 9(1);

(l) where modification to the power consumption is specified via frequency or voltage control, or both, and via pre-alert signal sent by the relevant system operator or the relevant TSO, be equipped to receive, directly or indirectly through a third party, the instructions from the relevant system operator or the relevant TSO, to measure the frequency or voltage value, or both, to command the demand trip and to transfer the information. The relevant system operator shall specify and publish the technical specifications approved to enable this transfer of information. For demand units connected at a voltage level below 110 kV, these specifications shall, prior to approval in accordance with Article 6, be subject to consultation with the relevant stakeholders in accordance with Article 9(1).”

Applicability: DUs offering DRS

Non-mandatory

The requirements stated in the Article 28 of DCC are related to the DUs offering the following services:

- Demand response active power control;
- Demand response reactive power control;
- Demand response transmission constraint management.

All three DRS' count in the DRS which are remotely controlled. This means that DUs offering this services change their demand after receiving commands from the relevant system operator (RSO).

According to the Article 28 of DCC, the DUs are not obligated to provide demand response (even if they are able to provide it), therefore all requirements related to DRS are non-mandatory, and therefore, it is not required to be implemented at the national level. Nevertheless, DRS have to be defined in the countries in which currently there are DUs offering DRS.

It must be underlined that for DUs connected at a voltage level below 110 kV, the requirements stated in the Article 28 of the DCC should be defined in consultation with the relevant stakeholders in accordance with DCC Article 9(1). Therefore, after defining these parameters and before sending them for approval, the relevant TSO should organize consultation with the relevant stakeholders in order to take into the consideration their opinions. It is also important to be noted that DUs can provide DRS collectively as part of demand aggregation through a third party when they are not part of a transmission-connected demand facility. However, if this is the case, this DUs still have to meet requirements stated in the Article 28.

The first requirement that should be defined by the RSO, it is the normal operational voltage range of the system at the connection point for DUs connected at a voltage level below 110 kV. Taking into account that all beneficiary countries should follow European standards, it is recommended that this non-executive requirement to be defined in accordance with EN 50160 standard. According to this standard, *during each period of one week 95% of the 10 min mean rms values of the supply voltage shall be within the range of $U_n \pm 10\%$ and all 10 minutes mean rms values of the supply voltage shall be within the range of $U_n +10\%/- 15\%$, under normal operating conditions.* It must be noted that this standard can be applied if DU is to be connected at a voltage level up to 35 kV (including 35 kV).

The requirements stated in paragraphs 2(c) and 2(l) of the Article 28 refer to the same topic. Namely, according to these paragraphs the DUs have to *be equipped to receive instructions, directly or indirectly through a third party, from the relevant system operator or the relevant TSO to modify their demand and to transfer the necessary information.* On the other hand, the RSO have to specify and make public available the technical specifications in order to enable transfer of this information. Having in mind that similarly information i.e. instruction have to be transfer to the PGM providing ancillary services (primary and secondary control), the technical specifications should be the same as for those PGMs. Therefore, the technical specifications depend on current practise applied by the particular TSO or RSO. The usually, the communication is realized via the remote terminal unit (RTU) installed in the user's facility. The technical specification of the RTU should be given by the RSO or the TSO. The RTU communicates with TSO/RSO SCADA system through the private network (it is recommended to avoid public networks) by some of the commonly used communication protocols. For exchanging digital commands and set-points it is recommended to use IEC 60870-5-104 or IEC 60870-5-101 communication standards. The information to be exchanged depending on demand response service that DU's owner offering to the RSO. The TSO and RSO should endeavour to the DUs are exchanging information only with one system operator.

The next requirement stated in the paragraph 2(f) of the Article 28, refers to a time period for which the DU offering DRS should be capable of adjusting its power consumption. This time period depends on type of the demand response that DU offering to the RSO or the relevant TSO. Taking into account that DR active power control can be introduced as a replacement reserve (tertiary control) or a frequency restoration reserve (secondary control) this time period by definition should be up to 15 minutes. With regard to DUs offering DR reactive power control and transmission constraint management, they have to mimic PGM's voltage and frequency regulation, therefore, the time period needed for adjusting power consumption should be notably shorter. However, having in mind that this time period depends on the type of processes carried out by the demand unit, the time period must be agreed between DU's owner and relevant system operator on a case-by-case basis.

According to the paragraph 2(i) of the Article 28, the owner of the DUs offering DRS have to notify the relevant system operator or relevant TSO of the modification of demand response capacity. The modalities of the notification should be specified by the relevant system operator or relevant TSO. Having in mind that DUs by providing DRS participate in providing ancillary service, modalities of the notification should be the same as for other users providing ancillary service. Therefore, the demand response capacity should be provided as scheduled data, through intraday and day ahead market processes.

Finally, in the paragraph 2(k) of the Article 28 is stated that relevant TSO has to specify rate of change of frequency withstand capability of the DUs offering DRS. This requirement should be defined in accordance with the Chapter 2.1.3. *Rate of Change of Frequency* of this document.

3.2.5. Power Quality

Article 20: *“Transmission-connected demand facility owners and transmission-connected distribution system operators shall ensure that their connection to the network does not result in a determined level of distortion or fluctuation of the supply voltage on the network, at the connection point. The level of distortion shall not exceed that allocated to them by the relevant TSO. TSOs shall coordinate their power quality requirements with the requirements of adjacent TSOs.”*

Applicability: TC DF and TC DS

Mandatory

Having in mind that the specification of the power quality requirements should be harmonized with neighbouring TSOs, the best way to do this is to use some of relevant international standards. Therefore, it is recommended to specify the level of voltage distortion or fluctuation of the supply voltage at the connection point in accordance with IEC/TR3 61000-3-7 and IEC/TR3 61000-3-6 standards.

3.3. System Restoration Issues

3.3.1. Short circuit requirements

Articles 14(1-3)(5)(8)(9):	<p><i>“1. Based on the rated short circuit withstand capability of its transmission network elements, the relevant TSO shall specify the maximum short circuit current at the connection point that the transmission-connected demand facility or the transmission-connected distribution system shall be capable of withstanding.</i></p> <p><i>2. The relevant TSO shall deliver to the transmission-connected demand facility owner or the transmission-connected distribution system operator an estimate of the minimum and maximum short circuit currents to be expected at the connection point as an equivalent of the network.</i></p> <p><i>3. After an unplanned event, the relevant TSO shall inform the affected transmission-connected demand facility owner or the affected transmission-connected distribution system operator as soon as possible and no later than one week after the unplanned event, of the changes above a threshold for the maximum short circuit current that the affected transmission-connected demand facility or the affected transmission-connected distribution system shall be able to withstand from the relevant TSO's network in accordance with paragraph 1.</i></p> <p><i>5. Before a planned event, the relevant TSO shall inform the affected transmission-connected demand facility owner or the affected transmission-connected distribution system operator, as soon as possible and no later than one week before the planned event, of the changes above a threshold for the maximum short circuit current that the affected transmission-connected demand facility or the affected transmission-connected distribution system shall be able to withstand from the relevant TSO's network, in accordance with paragraph 1.</i></p> <p><i>8. After an unplanned event, the transmission-connected demand facility owner or the transmission-connected distribution system operator shall inform the relevant TSO, as soon as possible and no later than one week after the unplanned event, of the changes in short circuit contribution above the threshold set by the relevant TSO.</i></p> <p><i>9. Before a planned event, the transmission-connected demand facility owner or the transmission-connected distribution system operator shall inform the relevant TSO, as soon as possible and no later than one week before the planned event, of the changes in short circuit contribution above the threshold set by the relevant TSO.”</i></p>
---------------------------------------------	----------------------------------------------------------------------------------------------------------------------------------------------------------------------------------------------------------------------------------------------------------------------------------------------------------------------------------------------------------------------------------------------------------------------------------------------------------------------------------------------------------------------------------------------------------------------------------------------------------------------------------------------------------------------------------------------------------------------------------------------------------------------------------------------------------------------------------------------------------------------------------------------------------------------------------------------------------------------------------------------------------------------------------------------------------------------------------------------------------------------------------------------------------------------------------------------------------------------------------------------------------------------------------------------------------------------------------------------------------------------------------------------------------------------------------------------------------------------------------------------------------------------------------------------------------------------------------------------------------------------------------------------------------------------------------------------------------------------------------------------------------------------------------------------------------------------------------------------------------------------------------------------------------------------------------------------------------------------------------------------------------------------------------------------------------------------------------------------------------------------------------------------------------------------------------------------------------------------------------------------------------------------------------------------------------------------------------------------------------------------------------------------------------------------------------------------------------------------------------------------------------------

Applicability: TC DF and TC DS

Mandatory

The short circuit requirements are mandatory, which means that they must be implemented at national level. The first one in the line of the requirements, it is stated in the paragraph 1 of the Article 14 of the DCC. According to the paragraph 1, the relevant TSO, based on the rated short circuit withstand capability of its transmission network elements, has to specify the maximum short circuit current at the connection point that the TC DF or the TC DS have to be capable of withstanding.

According to the *Implementation Guidance Document on Parameters of Non-exhaustive Requirements published* by the ENTSO-e, this is not the site specific requirement. This means that general value(s) have to be specified by the relevant TSO. Having in mind the previous a conclusion is being imposed that the relevant TSO has to specify the maximum short circuit currents at corresponding voltage levels which it expects to occur within its transmission system. This maximum short circuit currents are calculated for the perspective network and they represent the maximum short circuit currents for which the system was designed i.e. for which transmission network elements were rated. In other words, the relevant TSO commits to maintain the short circuit currents in each node of the system below this designed values. Therefore, the maximum short circuit currents that should be specified within this requirement do not represent the maximum short circuit currents that can be expected at the connection point, but the maximum short circuit currents for which the transmission system was designed. This means that all elements of the same voltage level of the particular transmission system will be rated for the same short circuit current which was determined during the transmission system design. As an example, values for the maximum short circuit currents depending on voltage level that are defined in [46] are given in Table below (Table 21).

Table 21 – An example of values for the maximum short circuit currents (data source [46])

Voltage level	Maximum Short-Circuit Current
110 kV	25 (standard)-31.5 (specific locations) kA
220 kV	40 kA
400 kV	50 kA

The maximum and minimum short circuit currents that can be expected at particular connection point the relevant TSO should specify within mandatory requirement stated in the paragraph 2 of the Article 14. According to this paragraph the relevant TSO has to deliver to the TC DF owner or the TC DS operator an estimate of the minimum and maximum short circuit currents to be expected at the connection point as an equivalent of the network. Being that, the maximum and minimum short circuit at the connection point depends on the location of the connection point, it seems that this is a site specific requirement. However, according to the *Implementation Guidance Document on Parameters of Non-exhaustive Requirements published* by the ENTSO-e, this is not the site specific requirement which means that general value(s) have to be specified by the relevant TSO. In order to specify the necessary values, the relevant TSO should calculate the short circuit currents at each node of its transmission network taking into account future changes in the network. Accordingly, the calculation should be performed for the winter maximum and the summer minimum taking into account existing and planned transmission connected facilities to be connected at the end of the considered five-year and ten-year period. The short circuit currents should be calculated for the three-phase and the one-phase short circuit by using some of the international standards. The use of the IEC 60909 standard it is recommended whereby the maximum short circuit currents should be calculated with the voltage factor 1.1 whereas the minimum short circuit currents should be calculated with the voltage factor 1. The operation condition to be taken into account in the calculation should provide the highest possible level of short circuit currents. The model of the transmission system to be used for calculation should include the impact of neighbouring TSOs i.e. the equivalents models of the neighbouring TSOs should be considered. This calculation should be performed at least once per year and particularly in the case of deviation from the planned order of the connections to the transmission system. The results of the calculation should be publicly available as well as the used standard and the used parameters in the calculation. By this calculation the relevant TSO will also perform a check whether short circuit current in some node of the system exceeds values defined within the first considered requirement, both for the current network state and for the future network configuration.

The requirements stated in the paragraphs 3, 5, 8 and 9 of the Article 14 address problems arising in the situations when it comes to a change in maximum short circuit currents at the connection point above values set within the first requirement (paragraph 1 of the Article 14). The change arises due to

unplanned or planned event in the transmission network or in the transmission connected facility (TC DF or TC DS). All four requirements define that in the previous mentioned situations, the relevant TSO and the owner/operator of the transmission connected facility (TCF) should inform each other depending on who caused the change. However, it is left up to the relevant TSO to specify threshold of the maximum short circuit current inducing a need for informing other side about exceeding this threshold. Having in mind that relevant TSO has to maintain the level of the short circuit currents below specified values, the relevant TSO should inform owner/operator of affected TCF if short circuit current at the connection point, due to unplanned or planned event in the transmission network, had exceeded value specified within the first requirement (paragraph 1 of the Article 14). In other words, some additional offset should not be introduced to the threshold of the maximum short circuit current at the connection point that is already specified by the relevant TSO. In the other hand, having in mind that the transmission system often is planned with a security margin of 10% of equipment ratings, in the case when short circuit current exceed threshold specified by the relevant TSO, due to unplanned or planned event in the TCF some offset to this threshold can be introduced. This offset should be up to 2% of the maximum specified short circuit current at the connection point. Therefore, if unplanned or planned event in the TCF results in an increase of the short circuit current at connection point more than 2% above the maximum short circuit current specified by the relevant TSO, the owner/operator of the TCF should inform the relevant TSO in accordance with paragraph 8 and 9 of the Article 14. This can be justified by the fact that a security margin of at least 8% is still considered sufficient for mitigations measures to be applied.

3.3.2. Demand Disconnection for System Defence

3.3.2.1. Low Frequency Demand Disconnection (LFDD)

Article 19(1)(a)(c): *“1. All transmission-connected demand facilities and transmission-connected distribution systems shall fulfil the following requirements related to low frequency demand disconnection functional capabilities:*

(a) each transmission-connected distribution system operator and, where specified by the TSO, transmission-connected demand facility owner, shall provide capabilities that enable automatic ‘low frequency’ disconnection of a specified proportion of their demand. The relevant TSO may specify a disconnection trigger based on a combination of low frequency and rate-of-change-of-frequency;

(c) the low frequency demand disconnection functional capabilities shall allow for operation from a nominal Alternating Current (‘AC’) input to be specified by the relevant system operator, and shall meet the following requirements:

(i) frequency range: at least between 47-50 Hz, adjustable in steps of 0,05 Hz;

(ii) operating time: no more than 150 ms after triggering the frequency setpoint;

(iii) voltage lock-out: blocking of the functional capability shall be possible when the voltage is within a range of 30 to 90 % of reference 1 pu voltage;

(iv) provide the direction of active power flow at the point of disconnection;”

Applicability: TC DF, TC DS

Mandatory

The low frequency demand disconnection functional capabilities which should be specified within these mandatory requirements largely depend on the low frequency demand disconnection (LFDD) schema established within particular transmission system. In other words, these capabilities have to

be fitted in the LFDD schema determined by the relevant TSO. LFDD schemes applied in each of the beneficiary countries were not available to the Consultant during the development of this study. However, even if LFDD schemes were known, analysing each of them would be beyond the scope of this study. Therefore, other approach had to be applied.

Taking into account that the frequency related parameters have the wide impact on the whole synchronous zone, the LFDD schemes have to be harmonized as much as possible between TSOs of the same synchronous area. In the counties of the European Union this is done through the Network Code Emergency and Restoration¹⁸. Having in mind that each of the beneficiary countries sooner or later will have to adopt the NC Emergency and Restoration (NC ER) it is recommended to define the LFDD functional capabilities in accordance with requirements seated out in the NC ER. On this way, a certain degree of the harmonization between TSOs of the same synchronous area will be achieved.

The NC ER does not define the LFDD functional capabilities, but it defines requirements related to the LFDD schema. According to the Article 15(5) of the NC ER *each TSO shall design the scheme for the automatic low frequency demand disconnection in accordance with the parameters for shedding load in real-time laid down in the Annex. The scheme shall include the disconnection of demand at different frequencies, from a 'starting mandatory level' to a 'final mandatory level', within an implementation range whilst respecting a minimum number and maximum size of steps. The implementation range shall define the maximum admissible deviation of netted demand to be disconnected from the target netted demand to be disconnected at a given frequency, calculated through a linear interpolation between starting and final mandatory levels. The implementation range shall not allow the disconnection of less netted demand than the amount of netted demand to be disconnected at the starting mandatory level. A step cannot be considered as such if no netted demand is disconnected when this step is reached.* According to the parameters from the Annex of the NC ER the 'starting mandatory level' of the frequency is 49 Hz whereas 'starting mandatory level' of the demand to be disconnected is 5 % of the total load at national level. The 'final mandatory level' of the frequency is 48 Hz whereby the 45 % of the total load at national level have to be disconnected. The 'implementation range' is $\pm 7\%$ of the total load at national level. The LFDD schema have to be realized through at least 6 steps whereby the difference between the steps has to be between 5 % and 10 % of the total load at national level. The maximum number of the steps it is not given, however in order to meet the above conditions it cannot be more than 10. The above described conditions are graphically presented on Figure below (Figure 56) for the LFDD schemes of 8 steps. The LFDD schema should be placed between red and blue line, taking care that the difference between the steps are in the permitted range.

¹⁸Commission Regulation (EU) 2017/2196 of 24 November 2017, establishing a Network Code on Electricity Emergency and Restoration (https://www.entsoe.eu/network_codes/er/)

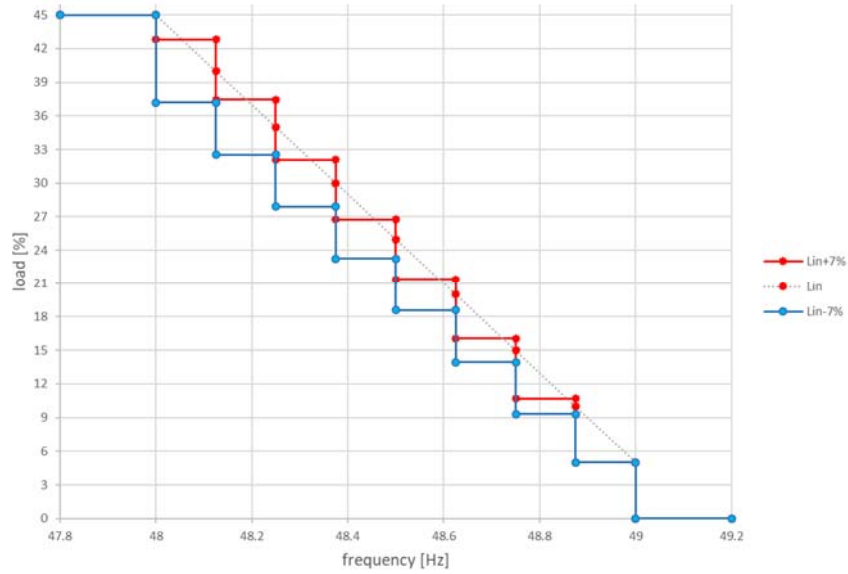

Figure 56 - Graphically presentation of the conditions for LFDD schema

Having in mind above mentioned the LFDD functional capabilities should be defined as follows. The proportion of demand of the TC DF or the TC DS to be automatically disconnected at low frequency depends on the share of the load of the TC DF or TC DS in the total national load. Therefore, this proportion should be fitted in the LFDD schema by disconnecting the certain amount of the load of the TC DF or the TC DS in one or more steps depending on configuration of the facility. The amount that can be disconnected in one step depends on how much load can be disconnected by opening one circuit breaker in particular TC facility.

From the previous it can be concluded that exact amount of demand to be disconnected in the particular TC facility and frequency threshold at which demand have to be disconnected, it cannot be specified generally, but rather to it have to be agreed between the relevant TSO and the owner/operator of the TC facility. This agreement should be achieved during the process of the issuing technical condition for the connection. However, it can be required that certain amount of demand can be disconnected stepwise depending on frequency, whereby the number of steps can be from 1 to 10 in the frequency range from 49 Hz to 48 Hz. Additionally, the requirements from the paragraph 1(c) of the Article 19 have to be satisfied. It is important to be emphasized that when defining the proportion of demand to be disconnected, the characteristics of demand, the critical loads and priority of the customers have to be also taken into account. Therefore, some of the TC DF or the TC DS may be released from fulfilling these requirements.

Having in mind that the under-frequency relays are usually placed at the TSO-DSO links, it must be underlined that the TC DS with mixed feeders with loads and high dispersed generation infeed should be omitted from the LFDD schema. In this case, the shift of the under-frequency relays to lower voltage levels must be considered.

Finally, in the paragraph 1(a) of the Article 19 is stated that relevant TSO *may specify a disconnection trigger based on a combination of low frequency and rate-of-change-of-frequency*. The focus is here on that the RoCoF can be used for determining level of a disturbance and hence determining the proportion of the demand to be disconnected. The RcCoF can be calculated as follows:

$$\left. \frac{df}{dt} \right|_{t=0^+} = \frac{-f_n P_k}{2 \sum_{i=1, i \neq k}^N H_i S_i}$$

wherein P_k is power of tripped generation, N is the number of SPGMs in the system, H_i and S_i are the inertial constant and installed capacity of the i^{th} SPGM, respectively. From the previous, it can be concluded that the RoFoF depends on level of a disturbance (P_k) but, it also highly depends on level of the total system inertia in the moment of the disturbance. Therefore, determining a proper range of the RoCoF it is not trivial and series of the studies should be conducted in order to avoid false tripping e.g. due to local faults or due to the normative incident in SA (for CE SA loss of 3000 MW), where the

RoCoF is very sensitive. Consequently, this functionality should be applied only in the countries in which import makes notable share in the production portfolio as well as in the countries which are located at periphery of the interconnection.

3.3.2.2. Low Voltage Demand Disconnection (LVDD) Scheme

**Article 19(2)(a-f),
19(3)(a-b):**

“2. With regard to low voltage demand disconnection functional capabilities, the following requirements shall apply:

(a) the relevant TSO may specify, in coordination with the transmission-connected distribution system operators, low voltage demand disconnection functional capabilities for the transmission-connected distribution facilities;

(b) the relevant TSO may specify, in coordination with the transmission-connected demand facility owners, low voltage demand disconnection functional capabilities for the transmission-connected demand facilities;

(c) based on the TSO's assessment concerning system security, the implementation of on load tap changer blocking and low voltage demand disconnection shall be binding for the transmission-connected distribution system operators;

(d) if the relevant TSO decides to implement a low voltage demand disconnection functional capability, the equipment for both on load tap changer blocking and low voltage demand disconnection shall be installed in coordination with the relevant TSO;

(e) the method for low voltage demand disconnection shall be implemented by relay or control room initiation;

(f) the low voltage demand disconnection functional capabilities shall have the following features:

(i) the low voltage demand disconnection functional capability shall monitor the voltage by measuring all three phases;

(ii) blocking of the relays' operation shall be based on direction of either active power or reactive power flow.

3. With regard to blocking of on load tap changers, the following requirements shall apply:

(a) if required by the relevant TSO, the transformer at the transmission-connected distribution facility shall be capable of automatic or manual on load tap changer blocking;

(b) the relevant TSO shall specify the automatic on load tap changer blocking functional capability.”

Applicability: TC DF, TC DS

Non-mandatory

The requirements stated in the Article 19(2) of the DCC are non-mandatory, which means that they do not have to be implemented at the national level. Besides, these requirements are also the site specific requirements. Therefore, if they are to be implemented at the national level they cannot be precisely defined for the general case, but rather to a general methodology for their definition can be given. This general methodology or general principles should be used by the relevant TSO in the process of issuing a technical condition for the connection.

As for the others non-mandatory requirements, firstly, the main motivation or the necessity for their implementation will be explained and then the recommendation for the national implementation will be given.

Within the requirements stated in the Article 19, the LVDD and on load tap changer blocking functional capabilities have to be specified. Therefore, having in mind that these functional capabilities are related to the voltage stability i.e. the voltage instability, some basic theoretical considerations about the voltage stability will be presented. The voltage stability can be categorized to large and small disturbance voltage stability depending on the magnitude of the disturbance. The small disturbance voltage stability refers to capability of the system to keep voltage in all nodes in the acceptable ranges after small disturbance such as the small changes in the load.

Having in mind that the basic phenomena that contribute to instability are essentially stationary (the change in the load happens in given moment for a small value), for analysing this type of the voltage stability the steady state analyses can be applied. In the other hand, the large disturbance voltage stability refers to capability of the system to keep voltage in all nodes in the acceptable ranges after the large disturbance such as a loss of a large generation unit, short circuit and etc. Since it is about fast transient changes, for analysing this type of the voltage stability the dynamic analyses have to be applied. The voltage stability can be further categorized to the transient (short term) and the long term voltage stability depending on the time frame of interest for analysing voltage stability. The previously described is graphically presented on Figure below (Figure 57). It should be emphasized that, voltage instability due to rotor angle instability is not considered here.

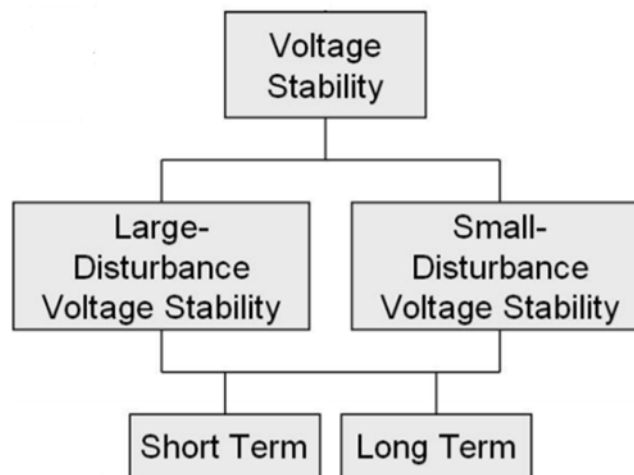

Figure 57 - Classification of the voltage stability (data source [45])

Having in mind that LVDD and on load tap changer blocking functional capabilities are in consideration here, the small disturbance and long term voltage stability are of the interest. The small disturbance voltage instability occurs when the system works at an unstable working point or on the edge of the stable regime. This often happens in the over loaded networks when loads exceeds capability of the network for production and transmission of the reactive power. In this situation the voltage control resources are exhausted, the generators reached the limits in overexcitation and tap changers are at the maximum or close to the maximum. Therefore, in this situation one small disturbance (increase of the load or an action of the tap changer) leads to progressive drop of the voltage and at the end to the voltage collapse. On the other hand, this can be also considered as the long term voltage instability due to increasing of the load and corresponding decreasing of the voltage happen stepwise within several days.

The short term voltage instability occurs in the situation when system was in the stable working point far from the edge of the instable regime, but it comes to sudden lack of the reactive power in some consumption nodes due to loss of generation units close to the big consumption nodes or transmission line tripping. The rest of the generation units are usually far from consumption, therefore it comes to the voltage drops. The voltage drops reduces reactive and active consumption, at the first moment, but due to action of the on load tap changers which are trying to recover voltage level at the low voltage side, the reactive and active consumption being recovered which leads to further voltage drops and at the end it can lead to complete voltage collapse. Due to slow action of the on load tap changers and slow recovery of the consumption, this can take for several minutes to several hours.

From the above mentioned it is clear that on load tap changers blocking and LVDD schema as last resort measures can be used for preventing described voltage instability. However, before the individual TSO decides to implements these requirements, a study aiming to asses if TSO's control area is prone to voltage instability should be conducted. This study should also determine whether implementation of the LVDD schema and the on load tap changers blocking contribute to preventing the voltage instability phenomenon. In other words, the study should determine whether the system in any of the scenarios (usually winter maximum) can approach to the unstable working point and whether the outages of any generation unit closed to consumption can lead to the occurrence of the long term voltage instability. If the results of the study shows that LVDD schema and on load tap changer blocking (OLTC blocking) should be implemented, then these functional capabilities have to be coordinated and fitted in the defence plan, see Figure below (Figure 58) (data source [45]). From Figure 2.3, it is clear that LVDD schema and the OLTC blocking are component of the system defence plan. Therefore, if the operational measures are insufficient to prevent the further decreasing of the voltage, the LVDD schema and the OLTC blocking should be applied as the last resort measures.

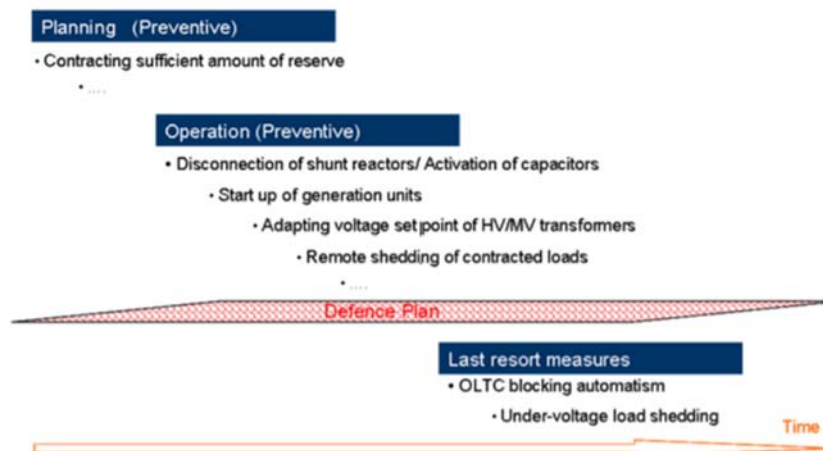

Figure 58 - Fitting the LVDD schema and OLTC blocking in the defence plan (data source [45])

It is important to be noted that in above consideration the LVDD schema and the OLTC blocking are always mentioned together, because, according to [45] it is recommended to utilize always both OLTC blocking and LVDD schema in a coordinated way.

Since the voltage instability starts from heavy loaded consumption nodes, the results of above mentioned study may show that there is no need for the implementation of the OLTC blocking and LVDD schema in all transmission connected facilities. This primarily refers to the TC DFs, which usually are not connected at heavy loaded consumption nodes.

If the relevant TSO decides to implement the LVDD schema and the OLTC blocking, then the requirements stated in the paragraphs 2 and 3 of the Article 19 have to be satisfied. This means that implementation of LVDD schema and OLTC blocking becomes binding for the TC distribution system operators, whereas, from the TC DF it can be required implementation of this functional capabilities. The equipment for both OLTC blocking and LDD schema have to be installed in coordination with the relevant TSO. The relevant TSO has to specify the following:

- The method for low voltage demand disconnection (relay or control room initiation);
- The method of the OLTC blocking (automatic or manual);
- If the automatic OLTC blocking is used, specification of the automatic OLTC blocking;

This parameters depend on the realization of the LVDD and OLTC blocking schemes. For correct realization of these schemes, the signals from the generation units and other elements (shunt reactor etc.) are needed as well as measurements from different power lines (active and reactive power). Having in mind that all this signals are available in the TSO's control centre, it is recommended to implement the LVDD and OLTC blocking schemes within centralized SCADA system i.e. wide area protection (WAP) scheme. This means that the LVDD and OLTC blocking should be initialized by the signals from TSO's SCADA system i.e. from TSO's control room.

3.3.2.3. Conditions for Reconnection and Disconnection

Article 19(4)(a-c): *“4. All transmission-connected demand facilities and transmission-connected distribution systems shall fulfil the following requirements related to disconnection or reconnection of a transmission-connected demand facility or a transmission-connected distribution system:*

(a) with regard to the capability of reconnection after a disconnection, the relevant TSO shall specify the conditions under which a transmission-connected demand facility or a transmission-connected distribution system is entitled to reconnect to the transmission system. Installation of automatic reconnection systems shall be subject to prior authorisation by the relevant TSO;

(b) with regard to reconnection of a transmission-connected demand facility or a transmission-connected distribution system, the transmission-connected demand facility or the transmission-connected distribution system shall be capable of synchronisation for frequencies within the ranges set out in Article 12. The relevant TSO and the transmission-connected demand facility owner or the transmission-connected distribution system operator shall agree on the settings of synchronisation devices prior to connection of the transmission-connected demand facility or the transmission-connected distribution system, including voltage, frequency, phase angle range and deviation of voltage and frequency;

(c) a transmission-connected demand facility or a transmission-connected distribution facility shall be capable of being remotely disconnected from the transmission system when required by the relevant TSO. If required, the automated disconnection equipment for reconfiguration of the system in preparation for block loading shall be specified by the relevant TSO. The relevant TSO shall specify the time required for remote disconnection.”

Applicability: TC DF, TC DS

Mandatory/non-mandatory (Article 19(4)(c))

The first requirement that should be defined it is related to the conditions under which a transmission-connected demand facility or a transmission-connected distribution system is entitled to reconnect to the transmission system after a disconnection due to disturbance. If the TC DS or the TC DF is disconnected from the transmission system due to a disturbance this means that some of the system’s parameter went out of the normal range or that the system is in an emergency situation. It should be emphasized that based on parameters measured in the one point (connection point) of the transmission system, it cannot be estimated current state of the system. For instance, if TC facility is disconnected due to tripping of the under-frequency relay, after disconnection frequency may turn back into normal range, but this does not mean that the system is not in the emergency situation. Therefore, it is recommended to allow reconnection only after the permission of the relevant TSO. Additionally, it should be required that frequency and voltage at connection point are in nominal operation ranges. Installation of the automatic reconnection systems it is not recommended, except for the automatic reconnection systems for reconnection after the one phase short circuit. However, if the relevant TSO permits installation of the automatic reconnection systems, the TC DF or the TC DS should be allowed to reconnect 15 minutes after disconnection if frequency and voltage at the connection point are in nominal ranges.

With regard to the settings of synchronisation devices, this site specific requirement should be defined by the relevant TSO during the connection phase of the TC DF or TC DS, but in due time for facility design, as it is the case for all the other site specific requirements.

The last requirement (paragraph 4(c) of the Article 19) is non-mandatory which means that it is not required to be implemented at national level. If the relevant TSO requires that a TC DF or a TC DS to be capable of being remotely disconnected from the transmission system, then the relevant TSO has to give the specification of the automated disconnection equipment. Additionally, time needed for remote disconnection should be specified. Having in mind that operation time for demand disconnection in case of tripping under-frequency relay has to be less than 150 ms (Article 19(1)(c) of the DCC), the time needed for remote disconnection should be at least the same. Since the specification of the automated disconnection equipment depends on configuration of the TC facility, this specification should be given on case-by-case basis.

3.4. Instrumentation, Simulation Models and Protections Issues

3.4.1. Electrical Protection Scheme and Settings

Article 16(1): *“1. The relevant TSO shall specify the devices and settings required to protect the transmission network in accordance with the characteristics of the transmission-connected demand facility or the transmission-connected distribution system. The relevant TSO and the transmission-connected demand facility owner or the transmission-connected distribution system operator shall agree on protection schemes and settings relevant for the transmission-connected demand facility or the transmission-connected distribution system.”*

Applicability: TC DF, TC DS

Mandatory

According to the Article 16(1) of the DCC, as mandatory non-exhaustive requirement the relevant TSO has to specify protecting devices and setting of these devices to be installed in the TC DS or TC DF in order to protect the transmission network. The devices and settings should be specified in accordance with the characteristics of TC DS or the TC DF. Accordingly, this is the site specific requirement, which means that general list of devices and corresponding settings cannot be given, instead general methodology can be specified by the relevant TSO. Precise list of the device and an initial settings should be given while issuing technical requirements for the connection. Before the commission of the TC DS or the TC DF, in due time, re-settings of the protection devices should be given by the relevant TSO. It should be pointed out that these settings, the relevant TSO should specify in such a way that the TC DS or the TC DF stay connected for the voltage and the frequency ranges which corresponds to the national implementation of the Article 12(1) and 13(1) of the DCC. Also, the low frequency and the low voltage demand disconnection schemes should be taken into account as well as the definition of requirements related to the automatic disconnection due to voltage level.

The second party of this requirement is exhaustive and it implies that the relevant TSO and the TC DF owner or the TC DS operator should agree on protection schemes and settings relevant for the TC DF i.e. the TC DS. Here, the recommendation of the Consultants is that relevant TSO should have the right to demand from the TC DF owner or the TC DS to conduct the protection settings study. The study should be conducted in coordination with the relevant TSO. The main objective of the study is justifying defined settings. However, an important advantage of the study is that the results of study can be used by the relevant TSO and the TC DF/DO owner/operator in case of need to change a protection device.

3.4.2. Control Requirements

Article 17(1): *“1. The relevant TSO and the transmission-connected demand facility owner or the transmission-connected distribution system operator shall agree on the schemes and settings of the different control devices of the transmission-connected demand facility or the transmission-connected distribution system relevant for system security.”*

Applicability: TC DF, TC DS

Mandatory

This is the site specific requirement, which means that general schemes and corresponding settings of the different control devices cannot be given, instead general methodology can be specified by the relevant TSO. Precise schemes of the different control device and an initial settings should be given while issuing technical requirements for the connection. Before the commission of the TC DS or the TC DF, in due time, re-settings of these devices should be given by the relevant TSO.

3.4.3. Information Exchanges

Article 18(1-3): *“1. Transmission-connected demand facilities shall be equipped according to the standards specified by the relevant TSO in order to exchange information between the relevant TSO and the transmission-connected demand facility with the specified time stamping. The relevant TSO shall make the specified standards publicly available.*

2. Transmission-connected distribution system shall be equipped according to the standards specified by the relevant TSO in order to exchange information between the relevant TSO and the transmission-connected distribution system with the specified time stamping. The relevant TSO shall make the specified standards publicly available.

3. The relevant TSO shall specify the information exchange standards. The relevant TSO shall make publicly available the precise list of data required.

Applicability: TC DF, TC DS”

Mandatory

Within this requirement, the relevant TSO has to specify the content of the information exchanges including a precise list of data and the time periods on which the information will be exchanged with TC DF and TC DS. Also, the communication protocols for the real time data exchanges should be specified. This is the mandatory requirement, which means that it has to be implemented at national level. The aims of this requirement are to be made the necessary conditions for the relevant TSO which will allow it to maintain system stability and security of supply. In order to do the previous, the relevant TSO must have a constant overview of the system states.

The precise list of information and data to be exchanged, depends on the operational strategies specified by the relevant TSO. However, having in mind that sooner or later each of the beneficiary countries will have to adopt the SO GL¹⁹, it is strongly recommended that the requirements related to information exchange being defined in accordance with the Article 41 - 53 of the SO GL.

¹⁹ Commission Regulation (EU) 2017/1485 of 2 August 2017, establishing a guideline on electricity transmission system operation (https://www.entsoe.eu/network_codes/sys-ops/)

According to these articles information to be exchange are divided into three groups, depending on the frequency of the information exchanges:

- Structural data
- Scheduled data
- Real time data

The lists of the structural and real time data to be exchanged between relevant TSO and DSO are given in the Chapter 3 of the SO GL. According to this Chapter there is no the scheduled data that should be exchanged. It should be pointed out that the lists given in the Chapter 3 do not take into account the data from PGMs connected to the distribution network which DSO forwarding to the relevant TSO. The structural data, DSO should provide during issuing the technical conditions for the connection, and as stated in the Article 43(4) of the SO GL, after connection of the TC DS, this data should be update at least every 6 mounts.

The lists of the structural, scheduled and real time data to be exchanged between relevant TSO and the demand facilities are given in the Chapter 6 of the SO GL. The Article 52 of the Chapter 6 defines the lists of data that should be exchanged between relevant TSO and TC DF with or without demand response, whereas, the Article 53 defines the list of data that should be exchanged between the relevant TSO and the distribution connected DF offering DR. As for TC DS, the structural data should be provided during issuing the technical conditions for the connection. The Chapter 6 does not define time frame for the updating the structural data, but it should be the same as for the TC DS. The scheduled data should be provided through intraday and dayahead market process as it is described for the PGMs.

With regard to the real time data, the same requirements should be required from both TC DS and TC DF. The distribution connected DF should be permitted to exchange the real time data with the relevant TSO through the third party as it is defined in the Article 53 of the SO GL. The real time data should be exchanged in real time with the update interval of at least 60 s or more frequently for the measurements, whereas commands should be transferred as fast as possible i.e. with delay which is less than 10 s. Communication protocol that should be used for the real time data exchange depends on current practice. The recommendation of the Consultants is the use some of the following protocols: IEC60870-6(ICCP/TASE.2), IEC 60870-5-104 and IEC 60870-5-101. These protocols support the time stamping.

3.4.4. Simulation Models

- Article 21(2-5):** *“2. Each TSO may require simulation models or equivalent information showing the behaviour of the transmission-connected demand facility, or the transmission-connected distribution system, or both, in steady and dynamic states.*
- 3. Each TSO shall specify the content and format of those simulation models or equivalent information. The content and format shall include:*
- (a) steady and dynamic states, including 50 Hz component;*
 - (b) electromagnetic transient simulations at the connection point;*
 - (c) structure and block diagrams.*
- 5. Each relevant system operator or relevant TSO shall specify the requirements of the performance of the recordings of transmission-connected demand facilities or transmission-connected distribution facilities, or both, in order to compare the response of the model with these recordings.”*

Applicability: TC DF, TC DS

Non-mandatory

The requirement related to the simulation models (Article 21(2) of the DCC) is not mandatory, therefore, it is not necessary to be implemented at the national level. However, if this requirement is implemented at national level, then requirements set out in paragraphs 3, 4 and 5 of the Article 21 have to also be implemented at the national level. In other words, if the TSO requires simulation models to be provided by the TC DF and/or the TC DS, then the TSO has to specify content and format of these models or equivalent information. Paragraphs 3 and 4 define what the specified content and format of the simulation models and sub-models should cover. If the models are required and the content and the format are specified then the TSO according to the paragraph 5 should specify the requirements of the performance of the recordings of the TC DF and/or the TC DS. This means that the TSO should specify performance of the recording equipment to be installed in the TC DF and/or TC DS.

Taking into account that content of the simulation models depends on a type and configuration of the transmission connected facility, requirement related to the simulation models is site specific. Accordingly, general content of the simulation models cannot be specified, instead general methodology can be specified by the TSO. Precise content of the simulation models should be required while issuing technical requirements for the connection or before commissioning of the transmission connected facility when all equipment is known and hence the characteristics of the equipment.

Having in mind that the TSO can form an individual grid models (IGD) from data obtained in process of issuing technical conditions for connection, the requirement related to the simulation model should be implemented a national level if there is a need for complex studies. These studies are often needed in the smaller weaker networks or areas of networks that are prone to oscillate. The less damped the network and hence prone to oscillate, the higher the detail of model that can reasonably be expected.

If there is a need for implementation of this requirement, the simulation models should be required in format of common used softer tools such as the DigSilent or the PSS[®]E, whereas the elements of the facility should be modelled in accordance with some of the international/national standards (either IEC or IEEE standard models). The requirements of the performance of the recordings of the TC DF and/or the TC DS should be specified in accordance with methodology given in the Chapter 1.5.2. of this document.

4. References

- [1] European Council. (2018). Commission Regulation (EU) 2016/631 of 14 April 2016 establishing a network code on requirements for grid connection of generators
- [2] European Council. (2018). Commission Regulation (EU) 2016/1388 of 17 August 2016 establishing a Network Code on Demand Connection
- [3] European Council. (2018). Commission Regulation (EU) 2016/1447 of 26 August 2016 establishing a network code on requirements for grid connection of high voltage direct current systems and direct current-connected power park modules
- [4] The Permanent High Level Group of Energy Community. (2018). DECISION No 2018/03/PHLG-EnC OF THE PERMANENT HIGH LEVEL GROUP OF THE ENERGY COMMUNITY of 12 January 2018 on incorporating Commission Regulation (EU) 2016/631 of 14 April 2016 establishing a Network Code on requirements for grid connection of generators in the Energy Community
- [5] The Permanent High Level Group of Energy Community. (2018). DECISION 2018/05/PHLG-EnC OF THE PERMANENT HIGH LEVEL GROUP OF THE ENERGY COMMUNITY of 12 January 2018 on incorporating Commission Regulation (EU) 2016/1388 of 17 August 2016 establishing a Network Code on Demand Connection in the Energy Community
- [6] The Permanent High Level Group of Energy Community. (2018). DECISION No 2018/04/PHLG-EnC OF THE PERMANENT HIGH LEVEL GROUP OF THE ENERGY COMMUNITY of 12 January 2018 on incorporating Commission Regulation (EU) 2016/1447 of 26 August 2016 establishing a network code on requirements for grid connection of high voltage direct current systems and direct current connected power park modules in the Energy Community
- [7] ENTSO-E. (2020). Parameters of Non-exhaustive Requirements, ENTSO-E, Guidance document for national implementation for network codes on grid connection
- [8] ENTSO-E. (2016). Parameters related to voltage issues, ENTSO-E guidance document for national implementation for network codes on grid connection
- [9] ENTSO-E. (2016). Reactive power control modes for PPM & HVDC, ENTSO-E guidance document for national implementation for network codes on grid connection
- [10] ENTSO-E. (2016). Reactive power requirement for PPMS & HVDC at low / zero power, ENTSO-E guidance document for national implementation for network codes on grid connection
- [11] ENTSO-E. (2016). Fault current contribution from PPMS & HVDC, ENTSO-E guidance document for national implementation for network codes on grid connection
- [12] ENTSO-E. (2016). Instrumentation, simulation models and protection, ENTSO-E guidance document for national implementation for network codes on grid connection
- [13] ENTSO-E. (2016). Selecting national MW boundaries, ENTSO-E guidance document for national implementation for network codes on grid connection
- [14] ENTSO-E. (2016). Demand Response - System Frequency Control, ENTSO-E guidance document for national implementation for network codes on grid connection
- [15] ENTSO-E. (2016). Reactive power management at T - D interface, ENTSO-E guidance document for national implementation for network codes on grid connection
- [16] ENTSO-E. (2016). Making non-mandatory requirements at European level mandatory at national level, ENTSO-E guidance document for national implementation for network codes on grid connection
- [17] ENTSO-E. (2017). High Penetration of Power Electronic Interfaced Power Sources (HPoPEIPS), ENTSO-E guidance document for national implementation for network codes on grid connection
- [18] ENTSO-E. (2018). Need for synthetic inertia (SI) for frequency regulation, ENTSO-E guidance document for national implementation for network codes on grid connection

- [19] ENTSO-E. (2020). Inertia and Rate of Change of Frequency (RoCoF), Version 17, SPD - Inertia TF
- [20] ENTSO-E. (2017). Fault current contribution from PPMS & HVDC, Draft of expert group FFCI
- [21] ENTSO-E. (2016). Reactive power control modes for PPM & HVDC ENTSO-E guidance document for national implementation for network codes on grid connection
- [22] IEEE. (2014). IEEE Guide for Identification, Testing and Evaluation of the Dynamic Performance of Excitation Control Systems
- [23] P.Kundur. (1994). Power System Stability and Control
- [24] KEMA DNV. (2013). Technical Report on ENTSO-E Network Code: Requirements for Generators
- [25] ENTSO-E. (2016). Reactive power management at T-D interface. ENTSO-E guidance document for national implementation for network codes on grid connection
- [26] Sandia National Laboratories. (2012). Reactive Power Interconnection Requirements for PV and Wind Plants - Recommendations to NERC
- [27] ENTSO-E. (2016). Instrumentation, simulation models and protection. ENTSO-E guidance document for national implementation for network codes on grid connection
- [28] ENERGINET.(2020).APPEDNI X 1.B - REQUIREMETNS FOR GENERATORS (RFG) REQUIREMETNS FOR SIMULATION MODELS
- [29] NETWORK CODE FOR REQUIREMENTS FOR GRID CONNECTION APPLICABLE TO ALL GENERATORS REQUIREMENTS IN THE CONTEXT OF PRESENT PRACTICES, 26.06.2012, WORKING DOCUMENT
- [30] ENTSO-E Rate of Change of Frequency (RoCoF) withstand capability ENTSO-E guidance document for national implementation for network codes on grid connection, 31 January 2018
- [31] Inertia and Rate of Change of Frequency (RoCoF) Version 17, SPD - Inertia TF 16. Dec. 2020
- [32] Frequency Stability Evaluation Criteria for the Synchronous Zone of Continental Europe - Requirements and impacting factors -RG-CE
- [33] System Protection & Dynamics Sub Group March 2016
- [34] Energy Networks Association Loss of Mains Protection Settings for all Small Generators Stakeholder Workshop 15 June 2018, London
- [35] SOGL
- [36] UCTE document "LOAD-FREQUENCY CONTROL AND PERFORMANCE, APPENDIX 1", version 1.9, level E, dated 16.06.2004.
- [37] Frequency Sensitive Mode, ENTSO-E guidance document for national implementation for network codes on grid connection", dated 31 January 2018
- [38] Entso-E Annual load - frequency report, 2019.
- [39] Limited frequency sensitive mode, ENTSO-E guidance document for national implementation for network codes on grid connection, dated on 31 January 2018
- [40] Maximum Admissible active power reduction at low frequencies, ENTSO-E guidance document for national implementation for network codes on grid connection, 31 January 2018
- [41] "Automatic connection/reconnection and admissible rate of change of active power",
- [42] ENTSO-E guidance document for national implementation of conditions for automatic connection / reconnection after incidental disconnection and admissible rate of change of active power, 31 January 2018
- [43] "Parameters related to frequency stability", ENTSO-E guidance document for national implementation for network codes on grid connection, 16 November 2016
- [44] Post-fault active power recovery, ENTSO-E guidance document for national implementation for network codes on grid connection, dated 16 November 2016.
- [45] ENTSO-E. (2010). Technical Background and Recommendations for Defence Plans in the Continental Europe Synchronous Area - LVDD schema
- [46] EirGrid's proposal for the general application of technical requirements in accordance with Articles 12 – 21 & Articles 27 – 30 of the Commission Regulation (EU) 2016/1388 establishing a Network Code on Demand Connection, 20 September 2018

5. Appendix 1

Table 22 - RfG Non-mandatory requirements (data source [16])

RfG			
Article	Requirement	General (G) or site specific (S) decision on introduction at national level	
		Requirement as such	Parameters
6 (3)	Industrial site - conditions for disconnection of generating modules with critical loads	S	S
13 (1) (a) (ii)	wider frequency ranges	S	S
13 (2) (b)	disconnection at randomized frequencies	G	S
13 (2) (f)	minimum regulation level of LFSM-O	S	-
13 (6)	remote control of active power output	S	-
14 (2) (b)	remote control of active power output	S	-
15 (2) (d) (iv)	shorter initial FSM response delay for PGMs without inertia	G	S
15 (5) (a) (ii)	quotation for providing black-start capability	S	G/S
15 (5) (b)	capability of island operation	S	G/S
15 (6) (b) (i)	definition of quality of supply parameters	S	G/S
15 (6) (c) (i)	provision of simulation models	G	S
15 (6) (c) (iv)	recordings of PGM performance	S	G/S
15 (6) (d)	additional devices for secure system operation	S	S
16 (2) (a) (ii)	shorter times of operation for simultaneous low voltage and high frequency	G	S
16 (2) (b)	wider voltage ranges and longer minimum times of operation	S	S
16 (2) (c)	voltage thresholds for automatic disconnection	S	S
17 (2) (a)	reactive power capability for synchronous PGMs	G	S
18 (2) (a)	supplementary reactive power compensation for HV connecting line of synchronous PGMs	G	S
20 (2) (a)	reactive power capability of PPMs	G	S
20 (2) (b)	fast fault current injection by PPMs	G	S
20 (2) (c)	asymmetrical fault current injection by PPMs	G	S
21 (2)	synthetic inertia capability of PPMs	G	S
21 (3) (a)	supplementary reactive power compensation for HV connecting line of PPMs	G	S
21 (3) (f)	power oscillations damping by the power park module	G	S

Table 23- DCC Non-mandatory requirements (data source [16])

DCC			
Article	Requirement	General (G) or site specific (S) decision on introduction at national level	
		Requirement as such	Parameters
12 (2)	wider frequency ranges	S	S
13 (6)	voltage thresholds for automatic disconnection	S	S
15 (1) d)	use of other metrics than power factor to set out reactive power capability ranges	G	G
15 (2)	Prohibition to export reactive power at an active power flow of less than 25% of the maximum import capability	G	S
15 (3)	active control of TSO-DSO reactive power exchange by the DSO	G	S
15 (4)	consideration of distribution system for TSO reactive power management	S	S
19 (1) (a)	contribution of transmission-connected demand facilities to low frequency demand disconnection	G	S
19 (1) (a)	use of combination of frequency and RoCoF thresholds for low frequency demand disconnection	G	G
19 (2) (a)	low voltage demand disconnection of transmission-connected distribution facilities	S	S
19 (2) (b)	low voltage demand disconnection of transmission-connected demand facilities	S	S
19 (2) (c) and (d); 19 (3)	on-load tap changer blocking	G	S
13 (6)	voltage thresholds for automatic disconnection	S	S
15 (1) d)	use of other metrics than power factor to set out reactive power capability ranges	G	G
15 (2)	Prohibition to export reactive power at an active power flow of less than 25% of the maximum import capability	G	S
15 (3)	active control of TSO-DSO reactive power exchange by the DSO	G	S
15 (4)	consideration of distribution system for TSO reactive power management	S	S
19 (1) (a)	contribution of transmission-connected demand facilities to low frequency demand disconnection	G	S
19 (1) (a)	use of combination of frequency and RoCoF thresholds for low frequency demand disconnection	G	G
19 (2) (a)	low voltage demand disconnection of transmission-connected distribution facilities	S	S
19 (2) (b)	low voltage demand disconnection of transmission-connected demand facilities	S	S
19 (2) (c) and (d); 19 (3)	on-load tap changer blocking	G	S
19 (4) (c)	remote disconnection of transmission-connected demand facilities or transmission-connected distribution facilities	G	G
21 (2)	provision of simulation models	G	S

6. Appendix 2

Table 24 - SPGM and PPM related requirements classified according to PGM type

	Type A	Type B	Type C	Type D
Frequency issues				
Frequency ranges	X	X	X	X
RoCoF withstand capability	X	X	X	X
LFSM-O	X	X	X	X
Admissible active power reduction	X	X	X	X
Logic Interface (1) (remote switch on/off)	X	X		
Automatic connection to the Network	X	X	X	X
Logic Interface (2)		X		
Frequency stability			X	X
Disconnection of load due to underfrequency			X	X
LFSM-U			X	X
FSM			X	X
Frequency restoration control			X	X
Real-Time monitoring of FSM			X	X
Rate of change of active power output			X	X
Instrumentation, simulation models and protection issues				
Control schemes and settings		X	X	X
Electrical protection schemes and settings		X	X	X
Information exchange		X	X	X
Loss of angular stability or loss of control			X	X
Instrumentation			X	X
Simulation models			X	X
Neutral point at the network side of step- up transformer treatment			X	X
Synchronisation			X	X
Angular stability (Capabilities to aid angular stability)				X
System restoration issues				
Reconnection capability		X	X	X
Black start			X	X
Capability of island operation			X	X
Operation following tripping to houseload (quick resynchronization capability)			X	X
Active power recovery		X	X	X
Voltage issues				
Fault Ride Through capability of synchronous generators connected below 110 kV		X	X	
Fault Ride Through capability of synchronous generators connected at 110 kV or above				X
Automatic disconnection due to the voltage level			X	X
Voltage ranges				X
Reactive power capability (simple)		X		
Reactive power capability at maximum active power			X	X
Reactive power capability below maximum active power			X	X
Voltage control system (simple)		X	X	
Voltage control system				X

Table 25 - PPM specific requirements classified according to PPM type

	Type A	Type B	Type C	Type D
Instrumentation, simulation models and protection issues				
Synthetic inertia capability			X	X
System restoration issues				
Post fault active power recovery		X	X	X
Voltage issues				
Fault ride through capability of power park modules connected below 110 kV		X	X	
Fault ride through capability of power park modules connected at 110 kV or above				X
Fast fault current		X	X	X
Reactive power capability (simple)		X		
Reactive power capability at maximum active power			X	X
Reactive power capability below maximum active power			X	X
Reactive power control modes			X	X
Priority to active or reactive power contribution			X	X
Power oscillations damping			X	X

7. Appendix 3

Table 26 - FRT Requirements for symmetrical faults applicable to type B, C and D SPGMs connected bellow 110 kV in ENTSO-e (1/3)

Austria (AT)				Belgium (BE)				Czech Republic (CZ), Poland (PL)				Germany (DE), Slovakia (SK), Slovenia (SL), Portugal (PT), Luxembourg (LU)			
tclear	0.15	Uret	0.3	tclear	0.2	Uret	0.3	tclear	0.15	Uret	0.05	tclear	0.15	Uret	0.3
trec1	0.15	Uclear	0.75	trec1	0.2	Uclear	0.7	trec1	0.15	Uclear	0.7	trec1	0.15	Uclear	0.7
trec2	0.4	Urec1	0.75	trec2	0.7	Urec1	0.7	trec2	0.7	Urec1	0.7	trec2	0.7	Urec1	0.7
trec3	0.94	Urec2	0.85	trec3	1.5	Urec2	0.9	trec3	1.5	Urec2	0.85	trec3	1.5	Urec2	0.85

Table 27 – FRT Requirements for symmetrical faults applicable to type B, C and D SPGMs connected bellow 110 kV in ENTSO-e (2/3)

Denmark (DK)				France (FR), Croatia (HR)				Greece (GR)				Hungary (HU), Romania (RO)			
tclear	0.25	Uret	0.3	tclear	0.15	Uret	0.05	tclear	0.15	Uret	0.3	tclear	0.25	Uret	0.3
trec1	0.25	Uclear	0.7	trec1	0.15	Uclear	0.7	trec1	0.15	Uclear	0.7	trec1	0.25	Uclear	0.7
trec2	0.7	Urec1	0.7	trec2	0.7	Urec1	0.7	trec2	0.15	Urec1	0.7	trec2	0.7	Urec1	0.7
trec3	1.5	Urec2	0.9	trec3	1.5	Urec2	0.9	trec3	1.5	Urec2	0.85	trec3	1.5	Urec2	0.85

Table 28 - FRT Requirements for symmetrical faults applicable to type B, C and D SPGMs connected bellow 110 kV in ENTSO-e (3/3)

Netherlands (NL), Italy (IT)				Spain (ES)			
tclear	0.15	Uret	0.05	tclear	0.15	Uret	0.05
trec1	0.15	Uclear	0.7	trec1	0.15	Uclear	0.7
trec2	0.15	Urec1	0.7	trec2	0.5	Urec1	0.7
trec3	1.5	Urec2	0.85	trec3	1.5	Urec2	0.85

FRT requirements for SPGMs below 110 kV ENTSO-e Practice

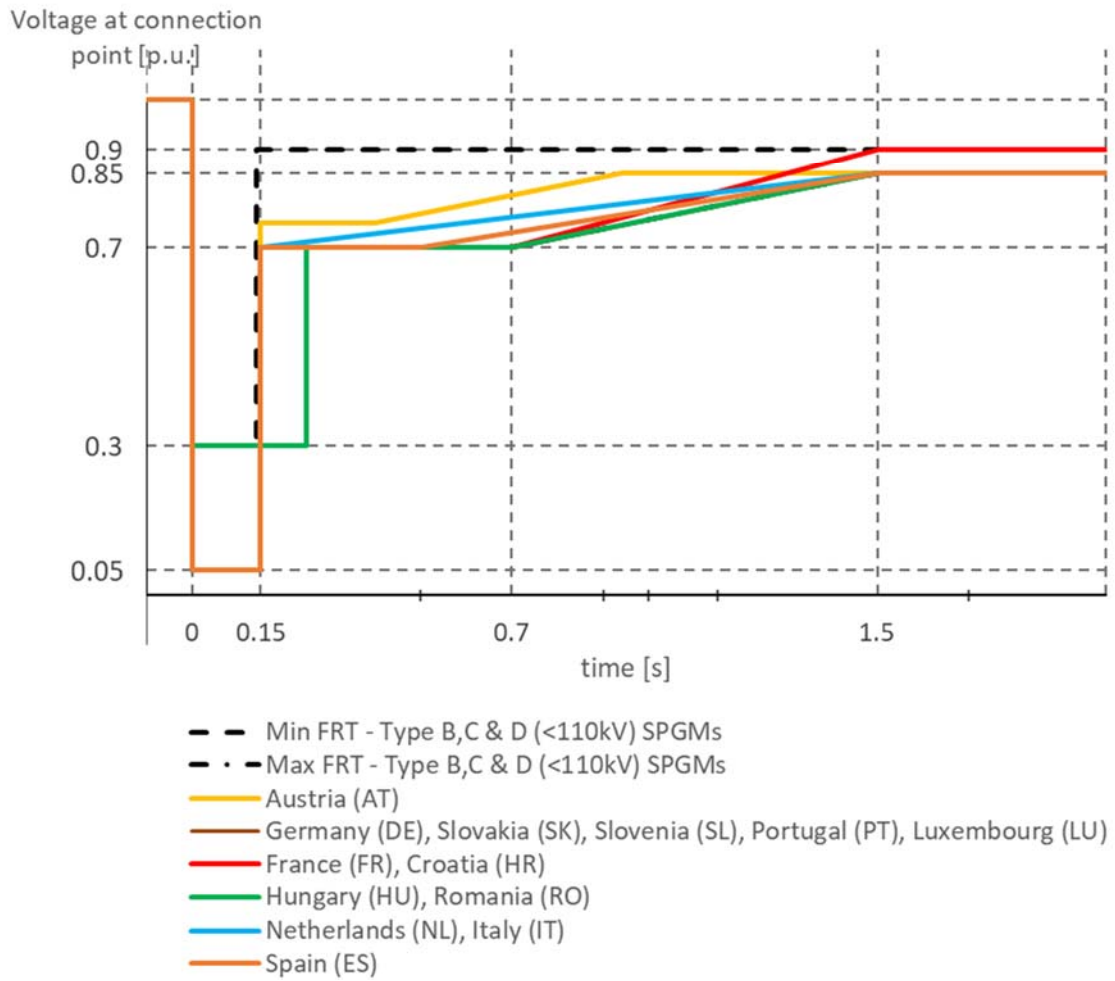

Figure 59 - FRT Requirements for symmetrical faults applicable to type B, C and D SPGMs connected below 110 kV in ENTSO-e

Table 29 – FRT Requirements for symmetrical faults applicable to type B, C and D PPMs connected bellow 110 kV in ENTSO-e (1/4)

Austria (AT), France (FR)				Belgium (BE)				Czech Republic (CZ)				Germany (DE), Luxembourg (LU)			
tclear	0.15	Uret	0.05	tclear	0.2	Uret	0.15	tclear	0.15	Uret	0.05	tclear	0.15	Uret	0.15
trec1	0.15	Uclear	0.05	trec1	0.2	Uclear	0.15	trec1	0.15	Uclear	0.05	trec1	0.15	Uclear	0.15
trec2	0.15	Urec1	0.05	trec2	0.2	Urec1	0.15	trec2	0.15	Urec1	0.85	trec2	0.15	Urec1	0.15
trec3	1.5	Urec2	0.85	trec3	1.5	Urec2	0.85	trec3	3	Urec2	0.85	trec3	3	Urec2	0.85

Table 30 – FRT Requirements for symmetrical faults applicable to type B, C and D PPMs connected bellow 110 kV in ENTSO-e (2/4)

Denmark (DK)				Croatia (HR)				Greece (GR), Hungary (HU)				Italy (IT)			
tclear	0.25	Uret	0.15	tclear	0.15	Uret	0.05	tclear	0.15	Uret	0.15	tclear	0.2	Uret	0.05
trec1	0.25	Uclear	0.15	trec1	0.15	Uclear	0.15	trec1	0.15	Uclear	0.15	trec1	0.2	Uclear	0.15
trec2	0.25	Urec1	0.15	trec2	0.15	Urec1	0.15	trec2	0.15	Urec1	0.15	trec2	0.2	Urec1	0.15
trec3	1.5	Urec2	0.9	trec3	1.5	Urec2	0.85	trec3	1.5	Urec2	0.85	trec3	1.5	Urec2	0.85

Table 31– FRT Requirements for symmetrical faults applicable to type B, C and D PPMs connected bellow 110 kV in ENTSO-e (3/4)

Netherlands (NL)				Spain (ES)				Poland (PO), Slovenia (SL)				Portugal (PT)			
tclear	0.25	Uret	0.05	tclear	0.2	Uret	0.05	tclear	0.15	Uret	0.05	tclear	0.15	Uret	0.05
trec1	0.25	Uclear	0.05	trec1	0.2	Uclear	0.05	trec1	0.15	Uclear	0.05	trec1	0.15	Uclear	0.05
trec2	0.25	Urec1	0.05	trec2	0.2	Urec1	0.05	trec2	0.15	Urec1	0.05	trec2	0.15	Urec1	0.05
trec3	3	Urec2	0.85	trec3	1.5	Urec2	0.85	trec3	2.5	Urec2	0.85	trec3	1.6	Urec2	0.85

Table 32– FRT Requirements for symmetrical faults applicable to type B, C and D PPMs connected bellow 110 kV in ENTSO-e (4/4)

Romania (RO)				Slovakia (SK)			
tclear	0.25	Uret	0.15	tclear	0.15	Uret	0.05
trec1	0.25	Uclear	0.15	trec1	0.15	Uclear	0.15
trec2	0.25	Urec1	0.15	trec2	0.15	Urec1	0.15
trec3	3	Urec2	0.85	trec3	3	Urec2	0.85

FRT requirements for PPMs below 110 kV ENTSO-e Practice

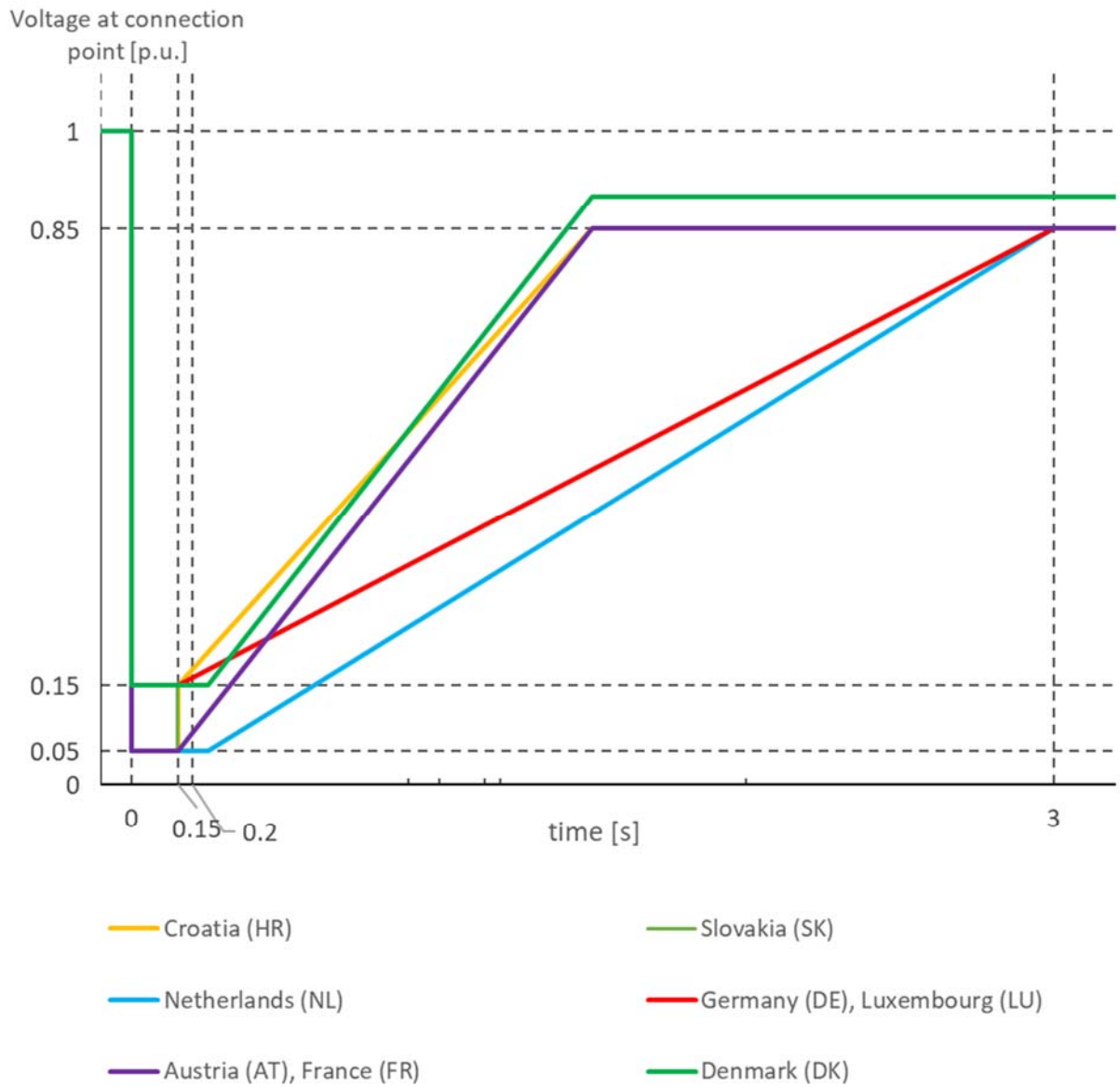

Figure 60 - FRT Requirements for symmetrical faults applicable to type B, C and D PPMs connected below 110 kV in ENTSO-e

Table 33– FRT Requirements for symmetrical faults applicable to type D SPGMs connected at or above 110 kV in ENTSO-e (1/4)

Austria (AT)				Belgium (BE)				Czech Republic (CZ), Italy (IT), Poland (PL), Portugal (PT)				Germany (DE), Luxembourg (LU)			
tclear	0.15	Uret	0	tclear	0.2	Uret	0	tclear	0.15	Uret	0	tclear	0.15	Uret	0
trec1	0.15	Uclear	0.25	trec1	0.45	Uclear	0.25	trec1	0.45	Uclear	0.25	trec1	0.3	Uclear	0.25
trec2	0.6	Urec1	0.6	trec2	0.6	Urec1	0.5	trec2	0.7	Urec1	0.5	trec2	0.5	Urec1	0.7
trec3	1.5	Urec2	0.85	trec3	0.8	Urec2	0.9	trec3	1.5	Urec2	0.85	trec3	1.5	Urec2	0.85

Table 34– FRT Requirements for symmetrical faults applicable to type D SPGMs connected at or above 110 kV in ENTSO-e (2/4)

Denmark (DK)				France (FR)				Greece (GR)				Croatia (HR)			
tclear	0.15	Uret	0	tclear	0.15	Uret	0	tclear	0.2	Uret	0	tclear	0.15	Uret	0
trec1	0.15	Uclear	0.6	trec1	0.15	Uclear	0.25	trec1	0.2	Uclear	0.25	trec1	0.15	Uclear	0.25
trec2	0.75	Urec1	0.6	trec2	0.7	Urec1	0.5	trec2	0.2	Urec1	0.5	trec2	0.6	Urec1	0.5
trec3	1.5	Urec2	0.85	trec3	1.5	Urec2	0.9	trec3	1.5	Urec2	0.85	trec3	1.5	Urec2	0.9

Table 35– FRT Requirements for symmetrical faults applicable to type D SPGMs connected at or above 110 kV in ENTSO-e (3/4)

Hungary (HU)				Spain (ES)				Netherlands (NL)				Romania (RO)			
tclear	0.16	Uret	0	tclear	0.15	Uret	0	tclear	0.25	Uret	0	tclear	0.25	Uret	0
trec1	0.4	Uclear	0.25	trec1	0.25	Uclear	0.25	trec1	0.3	Uclear	0.25	trec1	0.45	Uclear	0.25
trec2	0.4	Urec1	0.7	trec2	0.5	Urec1	0.7	trec2	0.3	Urec1	0.7	trec2	0.7	Urec1	0.7
trec3	1	Urec2	0.9	trec3	1.5	Urec2	0.85	trec3	1.5	Urec2	0.85	trec3	1.5	Urec2	0.85

Table 36– FRT Requirements for symmetrical faults applicable to type D SPGMs connected at or above 110 kV in ENTSO-e (4/4)

Slovenia (SL)				Slovakia (SK)			
tclear	0.15	Uret	0	tclear	0.25	Uret	0
trec1	0.15	Uclear	0.25	trec1	0.25	Uclear	0.25
trec2	0.6	Urec1	0.5	trec2	0.25	Urec1	0.5
trec3	1.5	Urec2	0.85	trec3	1.5	Urec2	0.85

FRT requirements for SPGMs at or above 110 kV ENTSO-e Practice

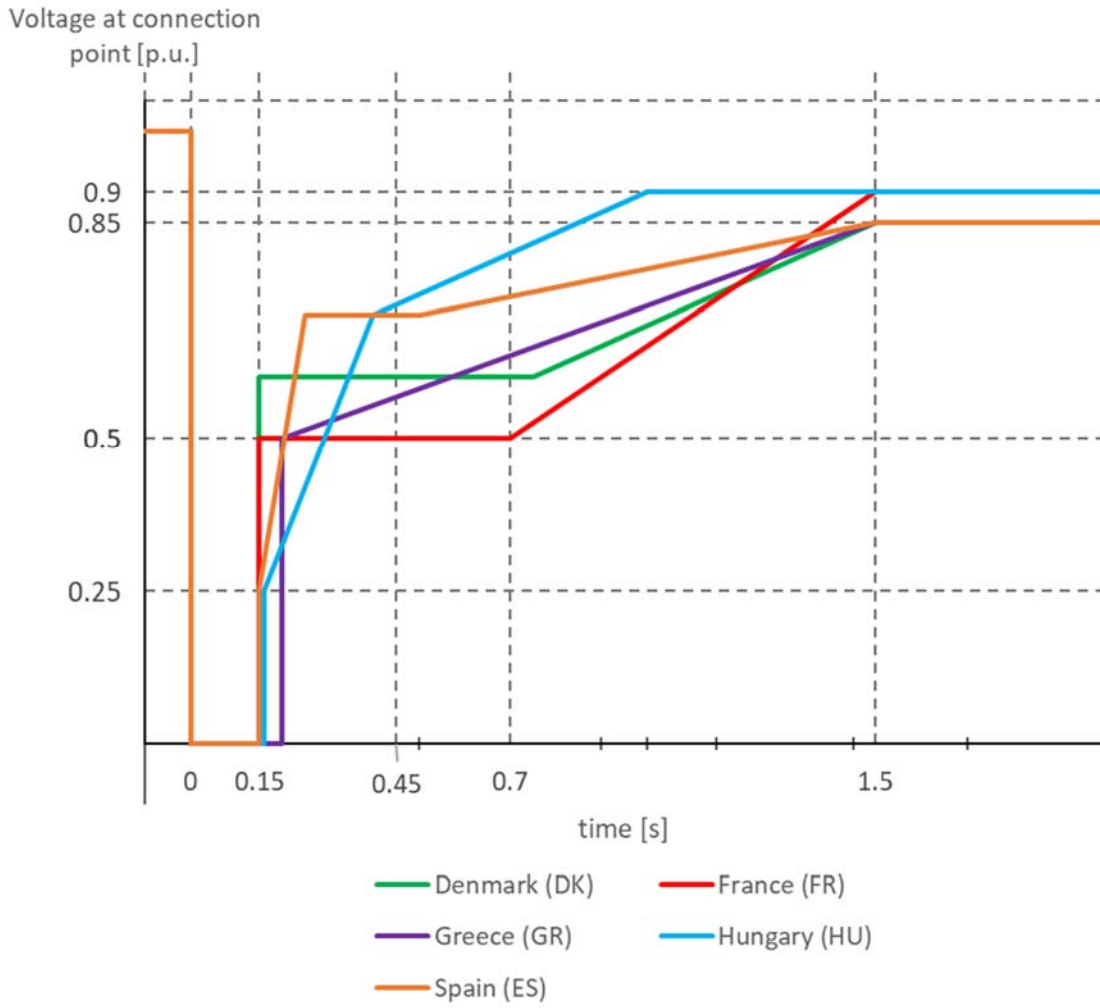

Figure 61- FRT Requirements for symmetrical faults applicable to type D SPGMs connected at or above 110 kV in ENTSO-e

Table 37– FRT Requirements for symmetrical faults applicable to type D PPMs connected at or above 110 kV in ENTSO-e (1/2)

Austria (AT), Denmark (DK), Spain (ES), Greece (GR), Croatia (HR), France (FR)				Belgium (BE)				Czech Republic (CZ), Germany (DE), Luxembourg (LU), Slovenia (SL)				Hungary (HU)			
tclear	0.15	Uret	0	tclear	0.2	Uret	0	tclear	0.15	Uret	0	tclear	0.16	Uret	0
trec1	0.15	Uclear	0	trec1	0.2	Uclear	0	trec1	0.15	Uclear	0	trec1	0.16	Uclear	0
trec2	0.15	Urec1	0	trec2	0.2	Urec1	0	trec2	0.15	Urec1	0	trec2	0.16	Urec1	0
trec3	1.5	Urec2	0.85	trec3	1.5	Urec2	0.85	trec3	3	Urec2	0.85	trec3	3	Urec2	0.85

Table 38– FRT Requirements for symmetrical faults applicable to type D PPMs connected at or above 110 kV in ENTSO-e (2/2)

Italy (IT)				Netherlands (NL), Romania (RO), Slovakia (SK)				Poland (PO)				Portugal (PT)			
tclear	0.2	Uret	0	tclear	0.25	Uret	0	tclear	0.15	Uret	0	tclear	0.15	Uret	0
trec1	0.2	Uclear	0	trec1	0.25	Uclear	0	trec1	0.15	Uclear	0	trec1	0.15	Uclear	0
trec2	0.2	Urec1	0	trec2	0.25	Urec1	0	trec2	0.15	Urec1	0	trec2	0.15	Urec1	0
trec3	2.8	Urec2	0.85	trec3	3	Urec2	0.85	trec3	2.5	Urec2	0.85	trec3	1.6	Urec2	0.85

FRT requirements for PPMs at or above 110 kV ENTSO-e Practice

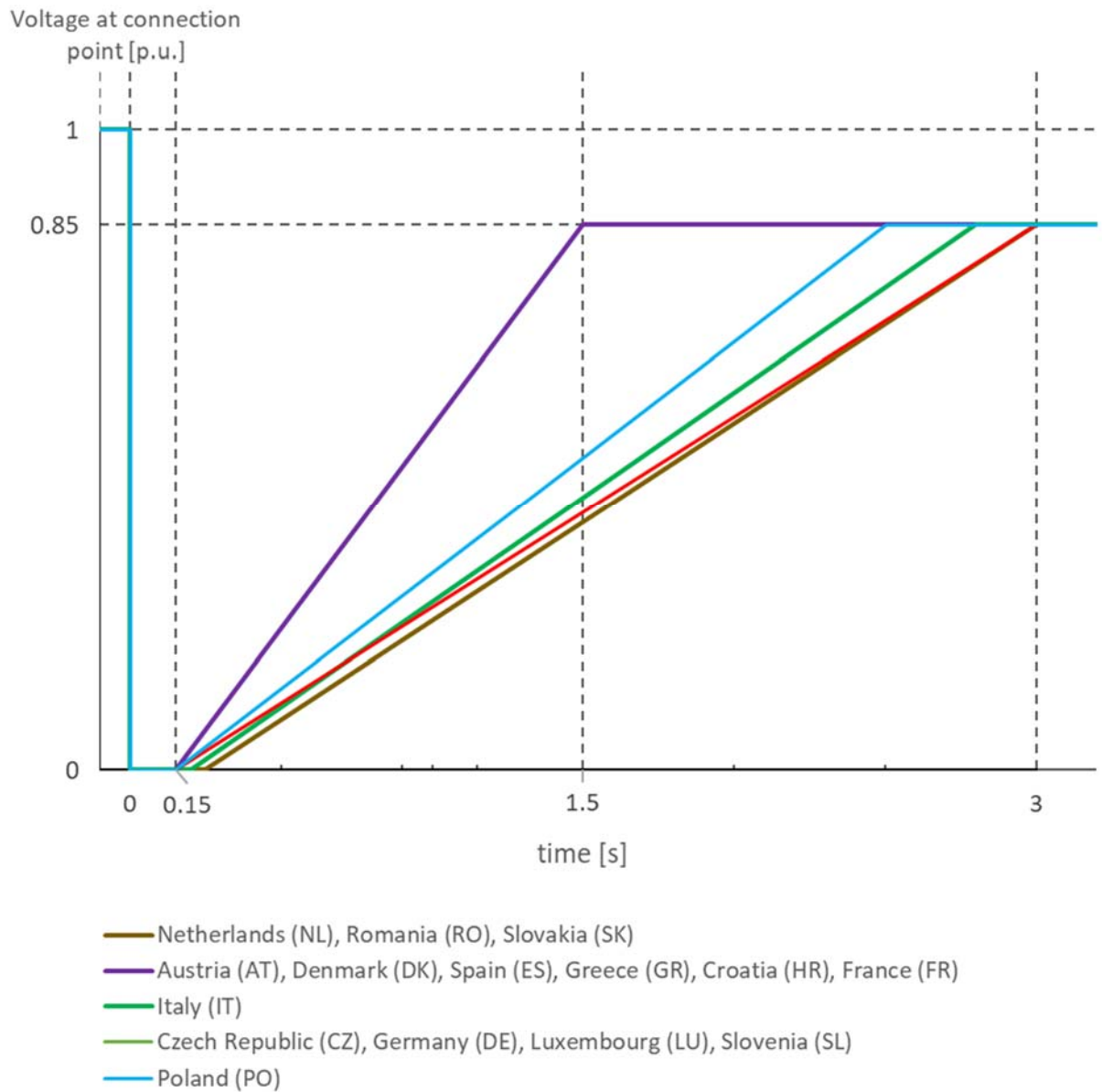

Figure 62 - FRT Requirements for symmetrical faults applicable to type D PPMs connected at or above 110 kV in ENTSO-e

8. Appendix

8.1.ENTSO-e practice for requirements applicable to type B PGMs

Table 39 – Reactive power capability requirement applicable to type B PGMs (1/2)

Austria (AU) ²⁰		Belgium (BE)		Spain (ES)		Croatia (HR)	Hungary (HU)	Poland (PO)	Portugal
U	Q/Pmax	U	Q/Pmax	U	Q/Pmax	Site-specific	Site-specific	General	General
0.9	0	0.9	0	0.95	0	at least Q/Pmax = ±0.33	0.95 lead 0.85 lag	0.85 lag @ Pn 0.05 lead @ Pn For P<Pn according to the P-Q capability diagram	Range U = [0.9÷1.1] Q/Pmax = [-0.33÷0.411]
0.95	-0.411	0.95	-0.33	1.05	-0.3				
1.1	-0.411	1.1	-0.33	1.05	0				
1.1	0	1.1	0	0.95	0.33				
1.05	0.411	1.05	0.33	0.95	0				
0.95	0.411	0.9	0.33						
0.9	0.329								

Table 40– Reactive power capability requirement applicable to type B PGMs (2/2)

Romania (RO)	Italy (IT)
General	General
Specified by the relevant system operator, according to a 0.9 lagging/leading power factor at the connection point	Type B connected to low voltage grid must have triangular capability with adjustable power factor between 0.95 lead to 0.95 lag Type B ≤400 kW connected to medium voltage: cosφ=0.98 lead @ Pn cosφ=0.9 lag @ Pn Type B >400 kW connected to medium voltage: cosφ=0.98 lead @ Pn cosφ=0.8 lag @ Pn

²⁰ Characteristic has 3 ranges. Range II characteristics (given in table) is applied in principle. It is also stated that “in locally limited exceptional cases, the relevant network operator can alternatively require reactive power range I or III in the network connection contract. This must be clearly and conclusively justified to the owner of the entire facility for power generation.”

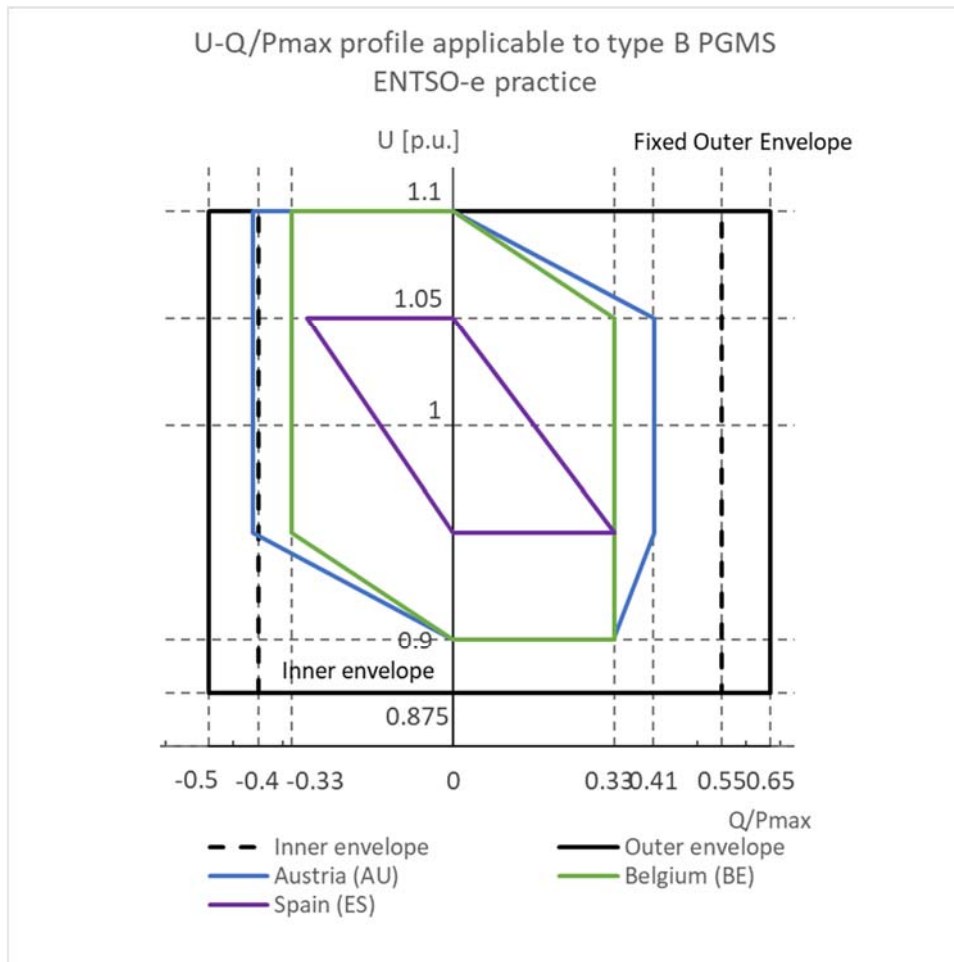

Figure 63 - Reactive power capability requirement applicable to type B SPGMs as implemented in ENTSO-e

8.2. ENTSO-e practice for requirements applicable to type C & D SPGMs

Table 41 – Reactive power capability requirement applicable to type C&D SPGMs (1/3)

Austria (AT) Variant I		Austria (AT) Variant II		Austria (AT) Variant III		Belgium (BE) U>300kV		Spain (ES)		Denmark (DK)	
U	Q/Pmax	U	Q/Pmax	U	Q/Pmax	U	Q/Pmax	U	Q/Pmax	U	Q/Pmax
0.875	0.329	0.875	0.329	0.875	0.329	0.9	0.45	0.95	0	0.9	0
1	-0.228	1	-0.329	0.975	-0.411	0.9	-0.1	1.05	-0.3	1	-0.2
1.1	-0.228	1.1	-0.329	1.1	-0.411	0.975	-0.25	1.05	0	1.05	-0.2
1.1	0	1.1	0	1.1	0	1.05	-0.25	0.95	0.3	1.05	0
1.05	0.484	1.05	0.411	1.05	0.329	1.05	0.3			1.04	0.4
						0.975	0.45			0.9	0.4
						Belgium (BE) U<300kV					
						1.05	-0.25				
						1.1	-0.25				
						1.1	0.2				
						1.05	0.3				

Table 42 – Reactive power capability requirement applicable to type C&D SPGMs (2/3)

Greece (GR) Type C		Greece (GR) Type D <300kV		Greece (GR) Type D >300kV	
U	Q/Pmax	U	Q/Pmax	U	Q/Pmax
0.875	0	0.875	0	0.875	0
0.95	0	0.95	0	0.9	0
0.95	-0.33	0.95	-0.5	0.9	-0.5
1.1	-0.33	1.1	-0.5	1.05	-0.5
1.1	0.33	1.1	0.45	1.05	0.45
0.875	0.33	0.875	0.45	0.875	0.45

Table 43– Reactive power capability requirement applicable to type C&D SPGMs (3/3)

Hungary (HU) Type C		Hungary (HU) Type D <220kV		Hungary (HU) Type D @220kV		Hungary (HU) Type D @400kV		Portugal (PT)		Italy (IT)	
U	Q/Pmax	U	Q/Pmax	U	Q/Pmax	U	Q/Pmax	U	Q/Pmax	U	Q/Pmax
1.09	0	1.1111	0	1.09375	0	1.05	0	0.875	0.6	1.1	-0.45
1	0.3	1	0.4	1	0.4	1	0.55	0.875	0.3	1.08	0
0.9	0.3	0.886	0.4	0.8839	0.4	0.95	0.55	0.875	-0.3	1.03	0.45
0.9	0	0.886	0	0.8839	0	0.95	0	1.1	-0.3	0.9	0.45
1	-0.3	1	-0.4	1	-0.4	1	-0.4	1.1	0.6	0.92	0
1.09	-0.3	1.1111	-0.4	1.09375	-0.4	1.05	-0.4			0.97	-0.45

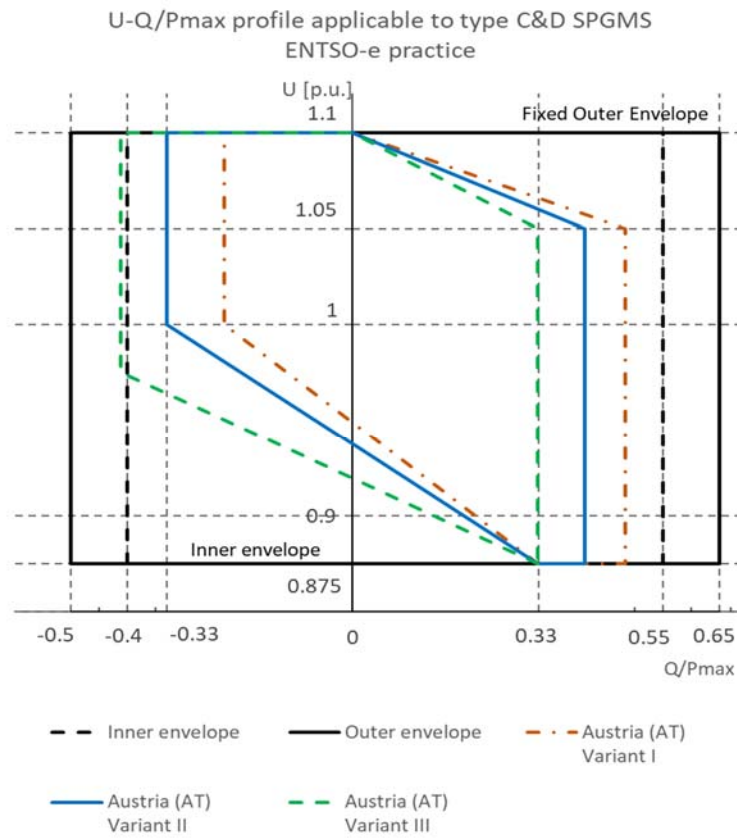

Figure 64 – Reactive power capability requirement applicable to type C & D SPGMS and PPMs implemented in Austria

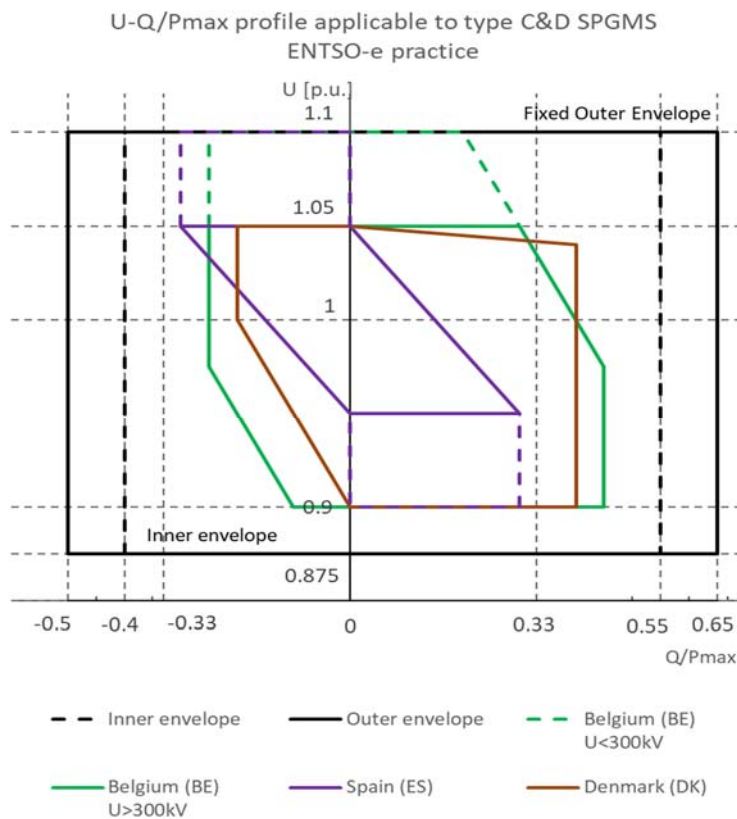

Figure 65 – Reactive power capability requirement applicable to type C & D SPGMS implemented in Belgium, Denmark and Spain²¹

²¹ In the case of Spain same requirement applies to SPGMS and PPMs

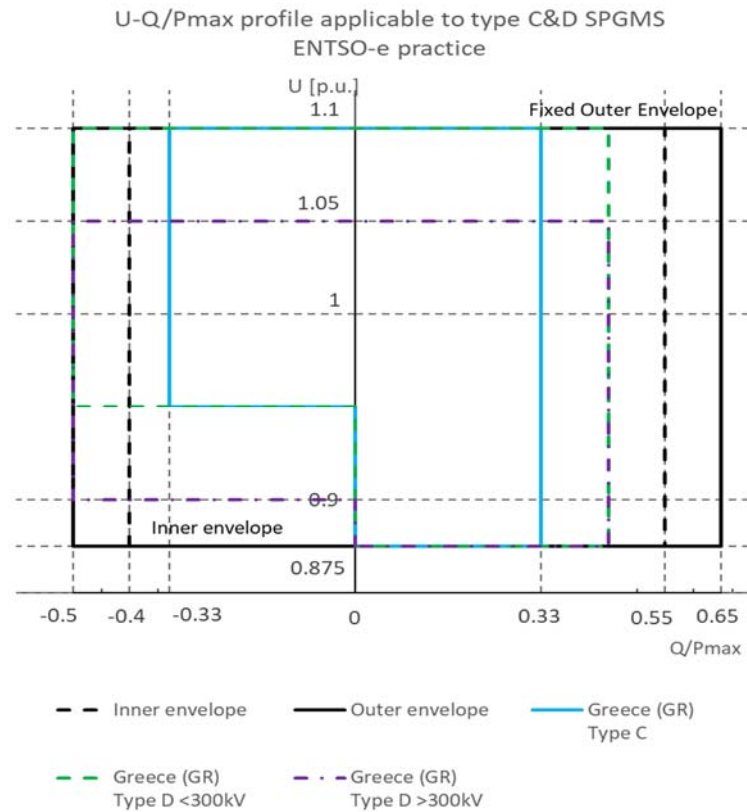

Figure 66– Reactive power capability requirement applicable to type C & D SPGMS implemented in Greece

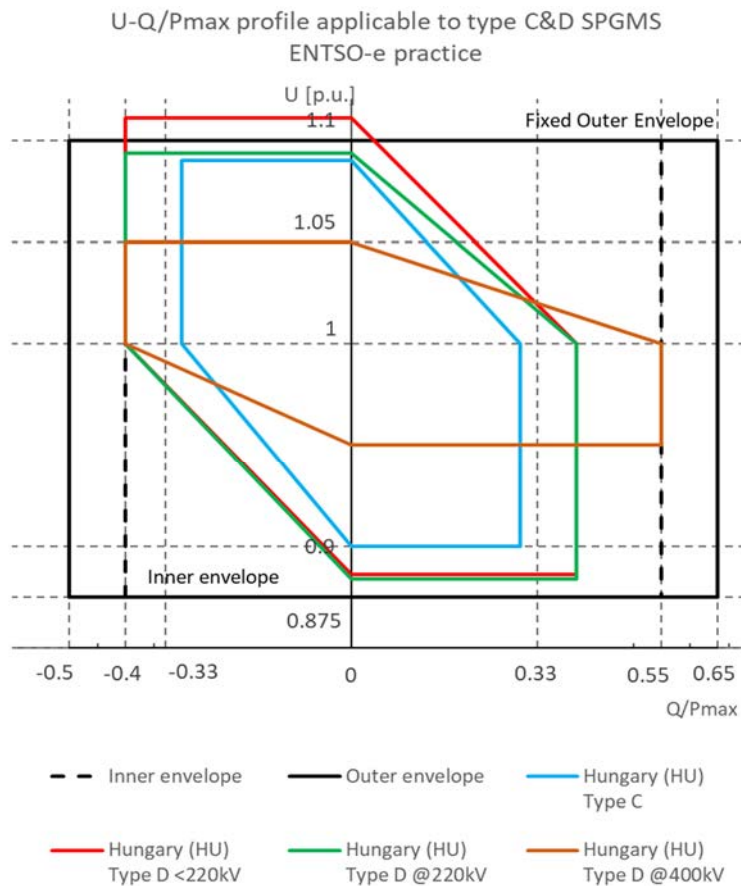

Figure 67– Reactive power capability requirement applicable to type C & D SPGMS implemented in Hungary

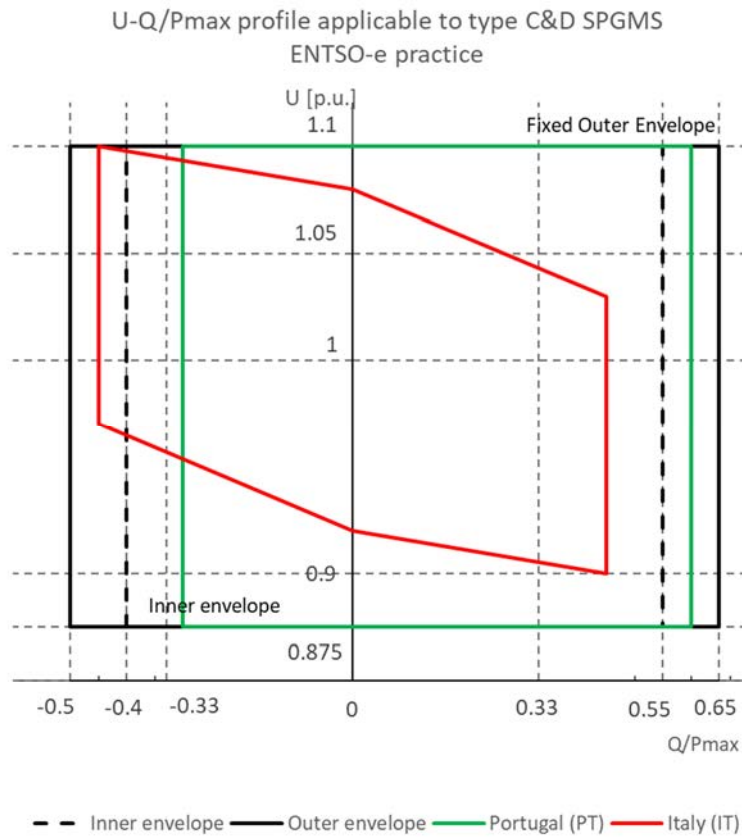

Figure 68– Reactive power capability requirement applicable to type C & D SPGMS implemented in Portugal and Italy

8.3. ENTSO-e practice for requirements applicable to type C & D PPMs

Table 44 – Reactive power capability requirement applicable to type C&D SPGMs (1/2)

Austria (AT) ²² Variant I		Austria (AT) Variant II		Austria (AT) Variant III		Czech Republic (CZ)		Spain (ES) ²³		Denmark (DK)	
U	Q/Pmax	U	Q/Pmax	U	Q/Pmax	U	Q/Pmax	U	Q/Pmax	U	Q/Pmax
0.875	0.329	0.875	0.329	0.875	0.329	1	-0.375	0.95	0	0.9	0
1	-0.228	1	-0.329	0.975	-0.411	1.1	-0.375	1.05	-0.3	0.96	-0.33
1.1	-0.228	1.1	-0.329	1.1	-0.411	1.1	0	1.05	0	1.05	-0.33
1.1	0	1.1	0	1.1	0	1	0.375	0.95	0.3	1.05	0
1.05	0.484	1.05	0.411	1.05	0.329	0.875	0.375			1.04	0.33
						0.875	0			0.9	0.33
						1	-0.375				

Table 45 – Reactive power capability requirement applicable to type C&D SPGMs (2/2)

Greece (GR) Type C		Greece (GR) Type D <300kV		Greece (GR) Type D >300kV		Hungary (HU) ²⁴ Type C&D base requirement	
U	Q/Pmax	U	Q/Pmax	U	Q/Pmax	U	Q/Pmax
0.9	0	0.9	0	0.9	0	0.95	-0.35
1	-0.3	1	-0.35	1	-0.35	1.1	-0.35
1.1	-0.3	1.1	-0.35	1.05	-0.35	1.1	0
1.1	0	1.1	0	1.05	0	1.05	0.35
1	0.25	1	0.2	1	0.2	0.875	0.35
0.9	0.25	0.9	0.2	0.9	0.2		

²² Same as for SPGMs

²³ Same as for SPGMs

²⁴ Requirement treated as site-specific

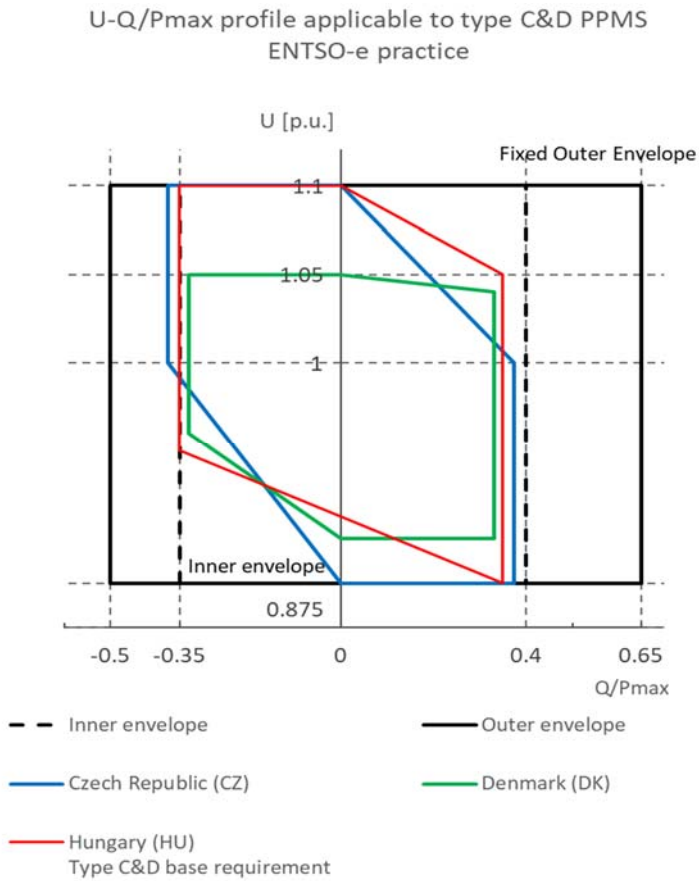

Figure 69– Reactive power capability requirement applicable to type C & D PPMS implemented in Czech Republic, Denmark and Hungary

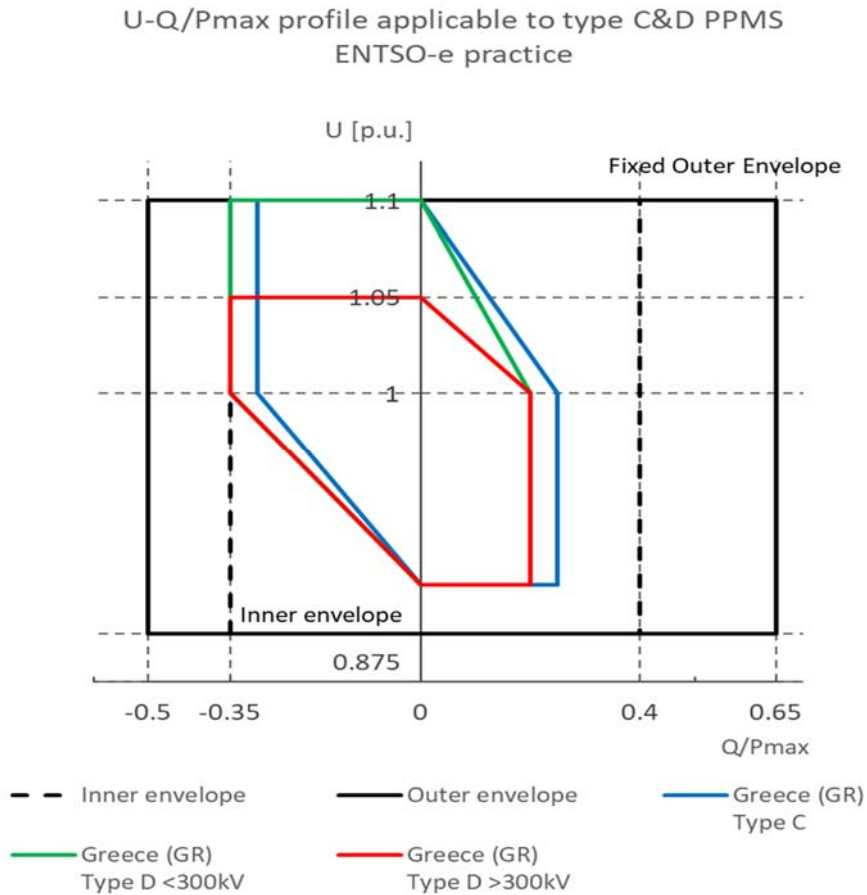

Figure 70– Reactive power capability requirement applicable to type C & D PPMS implemented in Greece

9. Appendix 5

Table 46 – ENTSO-e practice for parameters related to voltage and power factor control (1/2)

Voltage control											
Country:	Austria (AT)	Belgium (BE)	Czech Republic (CZ)	Germany (DE)	Denmark (DK)	Spain (ES)	France (FR)	Greece (GR)	Hungary (HU)	Italy (IT)	Netherlands (NL)
PSS threshold	200 MW	Site specific	All PGMS connected to TS	All type D SPGMs	25 MW (type D)s	50 MW	Do not require PSS instead impose tests demonstrating stability above type B.	50 MW	Site specific	Type D SPGMs	U = 220 kV
t1	1 s		4 s	1 s÷5 s (default 5 s)	1 s	1 s	5s	1 s÷5 s		1 s	Connection Agreement
t2	10 s		30 s		5 s	5 s	10 s	5 s÷60 s		5 s	
Power factor control											
Target power factor	1%	Site specific	Not-used	Site specific (default $\cos\phi=1$)			Q/Pmax = 0.48	Site specific	Site specific		Connection Agreement
Time period to reach the set point	10 s			1 min	begin 2 s end 30 s	<1 min	10 s			5 s	
Tolerance	±5% Qmax			±2% of installed capacity	accuracy within 2% Qmax	5%	0.2%			5%	

Table 47 – ENTSO-e practice for parameters related to voltage and power factor control (2/2)

Voltage control			
Country:	Poland (PL)	Portugal (PT)	Romania (RO)
PSS threshold	Type D PGMS with P > 20 MW	45 MW	usually 150 MW
t1	≤ 5 s	Site specific	1 s±5 s
t2	≤ 60 s		60 s
Power factor control			
Target power factor	cosφ=1	Site specific	
Time period to reach the set point	≤ 150 s		
Tolerance	Lower value of 5% Qmax or 5 Mvar		1%

DRAFTING OF PROVISIONS

List of Abbreviations

ACE	- Area Control Error
AGC	- Automatic Governor Control
APC	- Active Power Control
AVR	- Automatic Voltage Regulator
CCGT	- Combined Cycle Gas Turbine
CDS	- Closed Distribution System
CDSO	- Closed Distribution System Operator
CE	- Continental Europe
CE SA	- Continental Europe Synchronous Area
CNC	- Connection Network Codes
DCC	- Demand Connection Code
DF	- Demand Facility
DR	- Demand Response
DRS	- Demand Response Service
DR SFC	- Demand Response System Frequency Control
DS	- Distribution System
DSO	- Distribution System Operator
DU	- Demand Unit
EMF	- Electromotive Force
EnC	- Energy Community
ENTSO-E	- European Network of Transmission System Operators for Electricity
EU	- European Union
FCR	- Frequency Containment Reserves
FRR	- Frequency Restoration Reserves
FRT	- Fault Ride Through
FSM	- Frequency Sensitivity Mode
HVDC	- High Voltage Direct Current
HPP	- Hydro Power Plant
IGD	- Implementation Guidance Document
LFDD	- Low Frequency Demand Disconnection
LFSM	- Limited Frequency Sensitivity Mode
LFSM -O	- Limited Frequency Sensitivity Mode - Overfrequency
LFSM -U	- Limited Frequency Sensitivity Mode - Underfrequency
LV	- Low Voltage
NC	- Network Codes

NRA	- National Regulatory Authority
PE	- Power electronics
PEIPS	- Power Electronics Interfaced Power System
PGFO	- Power Generating Facility Owner
PGM	- Power Generating Module
PHLG	- Permanent High Level Group
PPM	- Power Park Module
PSS	- Power System Stabilizer
RES	- Renewable Energy Sources
RfG	- Requirements for Generators
RLPI	- RES Load Penetration Index
RoCoF	- Rate-of-Change-of-Frequency
RPC	- Reactive Power Control
RSO	- Relevant System Operator
SA	- Synchronous Area
SPGM	- Synchronous Power-Generating Module
SFC	- System Frequency Control
SPGM	- Synchronous Power-Generating Module
TC DF	- Transmission connected Demand Facility
TC DS	- Transmission Connected Distribution System, including Transmission Connected Distribution Facilities
TS	- Transmission System
TSO	- Transmission System Operator
TPP	- Thermal Power Plant
WTG	- Wind Turbine Generator

Definitions

Closed Distribution System	a distribution system classified as a closed distribution system by national regulatory authorities or by other competent authorities, where so provided by the EnC contracting party, which distributes electricity within a geographically confined industrial, commercial or shared services site and does not supply household customers, without prejudice to incidental use by a small number of households located within the area served by the system and with employment or similar associations with the owner of the system;
Connection point	the interface at which the PGM, demand facility, distribution system or HVDC system is connected to a transmission system, offshore network, distribution system, including closed distribution systems, or HVDC system, as identified in the connection agreement;
Demand facility	a facility which consumes electrical energy and is connected at one or more connection points to the transmission or distribution system. A distribution system and/or auxiliary supplies of a power generating module do not constitute a demand facility;
Demand unit	an indivisible set of installations containing equipment which can be actively controlled by a demand facility owner or by a CDSO, either individually or commonly as part of demand aggregation through a third party;
Grid User	assets/facilities and their owners connected to transmission or distribution networks;
Low Frequency Demand Disconnection	an action where demand is disconnected during a low frequency event in order to recover the balance between demand and generation and restore system frequency to acceptable limits;
Maximum capacity	the maximum continuous active power which a PGM can produce, less any demand associated solely with facilitating the operation of the PGM and not fed into the network as specified in the connection agreement or as agreed between the relevant system operator and the PGFO (usually noted as Pmax);
Maximum Export Capability	the maximum continuous active power that a transmission-connected demand facility or a transmission-connected distribution facility, can feed into the network at the connection point, as specified in the connection agreement or as agreed between the relevant system operator and the transmission-connected demand facility owner or transmission-connected distribution system operator respectively;
Maximum Import Capability	the maximum continuous active power that a transmission-connected demand facility or a transmission-connected distribution facility can consume from the network at the connection point, as specified in the connection agreement or as agreed between the relevant system operator and the transmission-connected demand facility owner or transmission-connected distribution system operator respectively;

closed distribution system	a distribution system classified as a closed distribution system by national regulatory authorities or by other competent authorities, where so provided by the EnC contracting party, which distributes electricity within a geographically confined industrial, commercial or shared services site and does not supply household customers, without prejudice to incidental use by a small number of households located within the area served by the system and with employment or similar associations with the owner of the system;
transmission-connected distribution system'	a distribution system connected to a transmission system, including transmission-connected distribution facilities;
maximum import capability'	the maximum continuous active power that a transmission-connected demand facility or a transmission-connected distribution facility can consume from the network at the connection point, as specified in the connection agreement or as agreed between the relevant system operator and the transmission- connected demand facility owner or transmission-connected distribution system operator respectively;
maximum export capability	the maximum continuous active power that a transmission-connected demand facility or a transmission-connected distribution facility, can feed into the network at the connection point, as specified in the connection agreement or as agreed between the relevant system operator and the transmission- connected demand facility owner or transmission-connected distribution system operator respectively;
low frequency demand disconnection	an action where demand is disconnected during a low frequency event in order to recover the balance between demand and generation and restore system frequency to acceptable limits;

1. Introduction

This report provides drafts for non-exhaustive requirements that should be implemented by the contracting parties. The first step towards implementation of CNC (both RfG and DCC) is for contracting parties to implement PHLG's decisions [4] and [5], i.e. to transpose Regulation (EU) 2016/631 and 2016/1388 into national legislation. According to [4] Article 1 Paragraph 2 ***“Transposition shall be made without changes to the structure and text of Regulation (EU)2016/631 other than translation and the adaptations made by the present Decision. For clarification, within one month after adoption of this Decision the Secretariat shall compile a correlation table in English with the adaptations made by the present Decision”***, and according to [5] Article 1 Paragraph 2 ***“Transposition shall be made without changes to the structure and text of Regulation (EU) 2016/1388 other than translation and the adaptations made by the present Decision. For clarification, within one month after adoption of this Decision the Secretariat shall compile a correlation table in English with the adaptations made by the present Decision”***. According to these decisions each contracting party should notify Energy Community Secretariat of completed transposition. The transposed documents are most likely going to take form of bylaws. These transposed documents are going to be referred in this report as **Transposed network code on requirements for grid connection of generators** and **Transposed network code on demand connection**. After the transposition of RfG and DCC a framework for further implementation of CNCs is established.

The next step would be to determine power thresholds for type B, C and D PGMs in accordance with [47] Article 5. As defined in [47] Article 5, Paragraph 3 proposals for maximum thresholds will be subjected to approval by the relevant NRA or *“where applicable Contracting Party”*. As stated in this article *“in forming proposals the relevant TSO shall coordinate with adjacent TSOs and DSOs and shall conduct a public consultation”*, and PGFOs shall assist TSOs during the process and provide data requested by the TSO. The public consultation procedure is defined in [47] Article 10. According to this article TSO should *“carry out consultation with stakeholders, including the competent authorities of each Contracting Party”*, and the consultation should last at least for period of one month. According to [47] Article 10, Paragraph 2 TSO *“shall duly take into account the views of the stakeholders resulting from the consultations prior to the submission of the draft proposal for thresholds, ... for approval by the regulatory authority or, if applicable, the Contracting Party. In all cases, a sound justification for including or not the views of the stakeholders shall be provided and published in a timely manner before, or simultaneously with, the publication of the proposal”*.

Defining power thresholds for type B, C and D PGMs is the second major step towards implementation of RfG. After this step each Contracting party should determine, define and implement requirements on non-exhaustive parameters. According to [47] Article 7 requirements of general application are established by RSOs or TSOs according to the **Transposed network code on requirements for grid connection of generators** and should be subjected to approval by the entity designated by the Contracting Party, i.e. NRA unless otherwise provided by the Contracting Party. According to [47] Article 7 Paragraph 4 RSO or TSO shall submit a proposal for requirements of general application, or the methodology used to calculate or establish them, for approval by the competent authority, i.e. NRA unless otherwise provided by the Contracting Party. The decision on proposed requirements or methodology should be issued within six months of the proposal receipt. For site specific requirements that are established by the RSOs and TSOs *“Contracting Party may require approval by a designated entity”*, but it is not mandatory. At last according to [47] Article 7 Paragraph 9. *“Where the requirements under this Regulation are to be established by a relevant system operator that is not a TSO, Contracting Parties may provide that instead the TSO be responsible for establishing the relevant requirements”*.

In following parts of the report drafts are given for the non-exhaustive requirements that are not defined or that are not compliant with RfG and DCC. It should be noted that some contracting parties have implemented both exhaustive and non-exhaustive requirements into their grid codes. This approach is not in compliance with PHLG's decisions [4] and [5], and previously described procedure

should be followed. However for implementation of such procedure it is not enough only for TSOs and DSOs to be involved in the process. It could be expected that transposition of [47] and [48] may require some amendments to the national laws and drafting and adopting of adequate bylaws. This is general remark that won't be repeated for each individual country. For requirements that are already in compliance with RfG and DCC, it is stated that current definition or current requirement can be used, and where needed some comments are given (e.g. "it should be clearly defined that the requirement shall be defined during the connection phase in due time for plant design"). In the cases where there are no existing implementation to non-exhaustive requirements, the definition is given assuming that there are already established **Transposed network code on requirements for grid connection of generators** and **Transposed network code on demand connection**, as this should be the first step in implementation of CNC at EnC level. For the non-mandatory requirements that are not recommended for implementation at this stage, until further analysis are conducted, according to the Methodology, designation N/A is given.

2. Provision of RfG Non-Exhaustive Requirements

2.1. Frequency Issues

2.1.1. Frequency Ranges

Non-exhaustive Requirement	Frequency Ranges - time period for operation
Articles 13(1)(a)(i), 13(1)(a)(ii):	<p>In addition to the Article 13(1)(a)(i) and 13(1)(a)(ii), Table 2 of Transposed network code on requirements for grid connection of generators type A, B, C and D power-generating modules shall be capable of staying connected to the network and operating for the time period and frequency range at the connection point as follows:</p> <ul style="list-style-type: none"> a) Frequency range 47.5Hz-48.5Hz: 30 minutes; b) Frequency range 48.5Hz-49.0Hz: 60 minutes.
Applicability:	Type A, B, C and D PGMs
Mandatory	
General	
Non-exhaustive Requirement	<p>Frequency Ranges - Potential wider frequency ranges</p> <p>Potential longer minimum times</p> <p>Specific requirements for frequency and voltage deviations</p>
Articles 13(1)(a)(i), 13(1)(a)(ii):	<p>In addition to the Article 13(1)(a)(i) and 13(1)(a)(ii), Table 2 of Transposed network code on requirements for grid connection of generators type A, B, C and D power-generating modules shall be capable of staying connected to the network and operating for the longer time period and wider frequency range at the connection point as follows:</p> <ul style="list-style-type: none"> a) Frequency range 47.0 Hz – 47.5 Hz 60 seconds; b) Frequency range 51.5 Hz – 52.5 Hz 60 seconds.
Applicability:	Type A, B, C and D PGMs
Non-mandatory	
Site specific	

2.1.2. Rate-of-Change-of-Frequency

Non-exhaustive Requirement	Rate-of-Change-of-Frequency - Max. RoCoF and measuring window for which PGM shall stay connected
Articles 13(1)(b)	According to the Article 13(1)(b) of Transposed network code on requirements for grid connection of generators type A, B, C and D power-generating module shall be capable of staying connected to the network and operate at rates of change of frequency is in range from -2 Hz/s to +1.5 Hz/s and measuring time window is in range from 2 to 5 cycle time of algorithms of turbine controller.
Applicability:	Type A, B, C and D PGMs
Mandatory	
General	

Non-exhaustive Requirement	Rate-of-Change-of-Frequency - Specify RoCoF of the loss of main protection
Articles 13(1)(b)	<p>According to the Article 13(1)(b) of Transposed network code on requirements for grid connection of generators type A, B, C and D power-generating module can define loss of main protection if rate of change of frequency is out of range from -2 Hz/s to +1.5 Hz/s, using minimum measuring time window of 2 cycle time of algorithms of turbine controller.</p> <p>RoCoF value should not be the only condition for loss of mains protection. It should be combined with two other conditions:</p> <ul style="list-style-type: none"> • RoCoF is above define value (+1.5 Hz/s, -2 Hz/s) in two algorithm cycle times; • Turbine speed/frequency is above 2% of rated speed or speed/frequency is less than 2% of rated speed; • At least one of switches which separates PGM from the transmission network is open.

The algorithm is shown on the figure below.

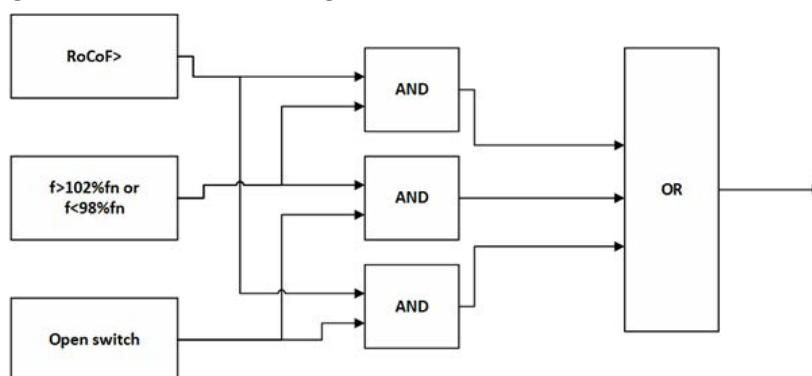

Applicability:	Type A, B, C and D PGMs
Mandatory	
Site specific	

2.1.3. Frequency Sensitive Mode

Non-exhaustive Requirement	<p>Active power range related to maximum capacity</p> <p>Frequency response insensitivity</p> <p>Frequency response dead band</p> <p>Droop</p>
Articles 15(2)(d)(i)	<p>In addition to the Article 15(2)(d), Table 4 and Table 5 of Transposed network code on requirements for grid connection of generators type C and D power-generating modules regarding to FSM shall fulfil requirements:</p> <ul style="list-style-type: none"> a) Maximum active power range related to maximum capacity: 8 %; b) Maximum frequency response insensitivity + maximum frequency response dead band: 10 mHz c) Minimum droop: 5% <p>These requirements are the most stringent requirements, and the TSO may require less stringent requirements, from defined ranges (Article 15(2)(d), Tables 4 and 5).</p>
Applicability:	Type C and D PGMs
Mandatory	
General range, site specific adjustable settings	
Non-exhaustive Requirement	Maximum admissible full activation time
Articles 15(2)(d)(iii)	<p>According to the Article 15(2)(d)(iii) of Transposed network code on requirements for grid connection of generators type C and D power-generating module in the event of a frequency step change shall be capable of activating full active power frequency response in maximum 30 s.</p>
Applicability:	Type C and D PGMs
Mandatory	
General	
Non-exhaustive Requirement	Maximum admissible initial delay for PGMs without inertia
Articles 15(2)(d)(iv)	<p>According to the Article 15(2)(d)(iv) of Transposed network code on requirements for grid connection of generators type C and D power-generating module without inertia, after frequency disturbance, regarding to delay in initial activation of active power frequency response, shall start response in 500 ms.</p>
Applicability:	Type C and D PGMs
Non -Mandatory	

General

Non-exhaustive Requirement

Time period for the provision of full active power frequency response

Articles 15(2)(d)(v)

According to the Article 15(2)(d)(v) of **Transposed network code on requirements for grid connection of generators** type C and D power-generating module shall be capable of providing full active power frequency response for a period of 30 minutes.

Applicability:

Type C and D PGMs

Mandatory

General

2.1.4. Limited Frequency Sensitivity Mode - Overfrequency

Non-exhaustive Requirement

Frequency threshold
Droop settings

Articles 13(2)(a)

According to the Article 13(2)(a) and figure 1 of **Transposed network code on requirements for grid connection of generators** type A, B, C and D power-generating module regard to the limited frequency sensitive mode — overfrequency (LFSM-O), the power-generating module shall be capable of activating the provision of active power frequency response according to figure 1 at a frequency threshold of 50.2 Hz and droop of 5 %.

Applicability:

Type A, B, C and D PGMs

Mandatory

General

Non-exhaustive Requirement

Use of automatic disconnection and reconnection

Articles 13(2)(b)

According to the Article 13(2)(b) of **Transposed network code on requirements for grid connection of generators** for type A power-generating module is allowed to use automatic disconnection and reconnection under the following conditions:

- a) Disconnection: frequency threshold= $50.2 \text{ Hz} + \text{Pref}/\text{P}_{\text{Amax}} \cdot 0.3 \text{ Hz}$;
- b) Reconnection: when frequency is less than
 - frequency threshold= $50.1 \text{ Hz} - \text{Pref}/\text{P}_{\text{Amax}} \cdot 0.05 \text{ Hz}$, not less than 60 seconds,

Pref – Unit rated power;

P_{Amax} – Maximum power for type A

Applicability: Type A

Non - Mandatory

General

Non-exhaustive Requirement Expected behavior of the PGM once the regulating minimum level is reached

Articles 13(2)(f) According to the Article 13(2)(f) of **Transposed network code on requirements for grid connection of generators** type A, B, C and D power-generating module upon reaching minimum regulating level, shall be capable continuing operation at minimum regulating level.

Applicability: Type A, B, C and D PGMs

Non - Mandatory

General

2.1.5. Limited Frequency Sensitivity Mode - Underfrequency

Non-exhaustive Requirement Frequency threshold
Droop
Definition of Pref

Articles 15(2)(c) regard to the limited frequency sensitive mode — Underfrequency (LFSM- According to the Article 15(2)(c) and figure 4 of **Transposed network code on requirements for grid connection of generators** type C and D power-generating module U), the power-generating module shall be capable of activating the provision of active power frequency response according to figure 4 at a frequency threshold of 49.8 Hz and droop of 5 %, considering that Pref=Pmax.

Applicability: Type C and D PGMs

Mandatory

General

2.1.6. Admissible Active Power Reduction

Non-exhaustive Requirement	Admissible active power reduction from max. output with falling frequency
Articles 13(4)	According to the Article 13(4) and figure 2 of Transposed network code on requirements for grid connection of generators type A, B, C and D power-generating module admissible active power reduction from maximum output with falling frequency below 49,5 max reduction rate of 10 % is allowed.
Applicability:	Type A, B, C and D PGMs
Mandatory	
General	
Non-exhaustive Requirement	Definition of the ambient conditions applicable when defining the admissible active power reduction and take into account of the capabilities of PGM
Articles 13(5)	<p>According to the Article 13(5) of Transposed network code on requirements for grid connection of generators type A, B, C and D power-generating module, admissible active power reduction from maximum output is defined under the following ambient conditions:</p> <ul style="list-style-type: none"> a) average annual temperature; b) average annual humidity; c) altitude, <p>of the place where the PGM (gas turbine) is located.</p>
Applicability:	Type A, B, C and D PGMs
Mandatory	
General	

2.1.7. Logic Interface and automatic connection to the network

Non-exhaustive Requirement	Requirements for the additional equipment necessary to allow active power output to be remotely operable
Articles 13(6)	<p>According to the Article 13(6) of Transposed network code on requirements for grid connection of generators for type A and B power-generating module shall be equipped with a logic interface, the additional equipment, necessary to allow active power output to be remotely operable. During the connection process in due time for plant design, if the DSO has a SCADA system that allows the logical interface to be used to cease active power, the TSO needs to specify:</p> <ul style="list-style-type: none"> — power threshold to which the requirement applies — type of telecommunication connection to PGM — telecommunication interface — list of signals from the PGM — how to send a command to cease active power

Applicability: Type A and B

Non - Mandatory

Site specific

•

Non-exhaustive Requirement Automatic Connection to the Network

According to the Article 13(7) of **Transposed network code on requirements for grid connection of generators** for type A, B and C power-generating module shall be capable of connecting automatically to the network under the following conditions:

- a) Voltage range: $0.9 \text{ pu} \leq U \leq 1.1 \text{ pu}$; and
- b) Frequency range: $49.9 \text{ Hz} \leq f \leq 50.05 \text{ Hz}$
- c) Minimum observation time:
 - $T_{\text{obs}} = 30 \text{ s} + P_{\text{ref}}/P_{\text{Cmax}} \cdot 300 \text{ s}$, where,
 - P_{ref} – Unit rated power;
 - P_{Cmax} – Maximum power for type C.;
- d) Maximum gradient of active power increase $\leq 20\%$ of $P_{\text{max}}/\text{min}$

Articles 13(7)

The principle for automatic reconnection after an incidental disconnection is as depicted on Figure below.

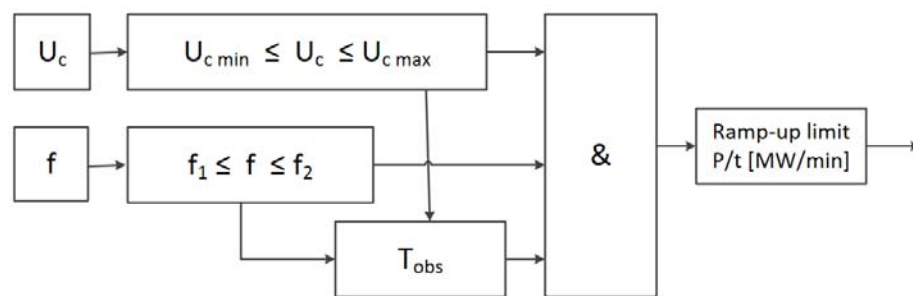

Applicability: Type A, B and C

Mandatory

General

Non-exhaustive Requirement Logic Interface (2)

According to the Article 14(2)(b) of **Transposed network code on requirements for grid connection of generators** type B power-generating module shall be equipped with additional equipment to allow active power output to be remotely operated. During the connection process in due time for plant design, if the DSO has a SCADA system that allow possibilities that active power output to be remotely operated, the TSO needs to specify:

Articles 14(2)(b)

- power threshold to which the requirement applies (if it is not general for type B)
- type of telecommunication connection to PGM
- telecommunication interface

- list of signals from the PGM
- the manner in which the active power is set (impulses of setpoint).

Applicability: Type B

Non - Mandatory

Site specific

-
-

2.1.8. Frequency Stability

Non-exhaustive Requirement

Time period to reach the adjusted active power set point
 Tolerance applying to the new set point
 Time period to reach tolerance applying to the new set point

Articles 15(2)(a)

According to the Article 15(2)(a) of **Transposed network code on requirements for grid connection of generators** type C and D power-generating module shall be capable of adjusting an active power setpoint in time period of 15 minutes with tolerance 1% Pmax.

Applicability: Type C and D

Mandatory

General

2.1.9. Frequency Restoration Control

Non-exhaustive Requirement

Specifications of the frequency restoration control

Articles 15(2)(e)

According to the Article 15(2)(e) of **Transposed network code on requirements for grid connection of generators** type C and D power-generating module shall fulfil requirements defined for frequency restoration reserves (SOGL 158(1)):

- a) a FRR providing unit or FRR providing group for automatic FRR shall have an automatic FRR activation delay not exceeding 30 seconds;
- b) a FRR provider shall ensure that the FRR activation of the FRR providing units within a reserve providing group can be monitored. For that purpose, the FRR provider shall be capable of supplying to the reserve connecting TSO and the reserve instructing TSO real-time measurements of the connection point or another point of interaction agreed with the reserve connecting TSO concerning:
 - time-stamped scheduled active power output;
 - time-stamped instantaneous active power for:
 - each FRR providing unit,
 - each FRR providing group, and
 - each power generating module or demand unit of a FRR providing group with a maximum active power output larger than or equal to 1,5 MW;

Minimal rate of change in the power output, regarding to frequency restoration control is defined according to type of PGMs:

- a) Gas-fired TPP - 8%Pmax/minute
- b) Coal-fired TPP - 2%Pmax/minute
- c) Nuclear TPP - 1%Pmax/minute
- d) Other PGMs - 20%Pmax/minute

Applicability: Type C and D

Mandatory

General

2.1.10. Real-Time Monitoring of FSM

Non-exhaustive Requirement List of the necessary data which will be sent in real time
Definition of additional signals

Articles 15(2)(g) In addition to the Article 15(2)(g) of **Transposed network code on requirements for grid connection of generators** type C and D power-generating modules, in order to verify the performance of the active power frequency response provision of participating PGMs, shall be equipped to transfer in real time the follow additional parameters:

- limits of active power,
- control mode of PGM,
- Command for turn on/of FSM,
- Command for simulation testing of FSM.

Applicability: Type C and D

Mandatory

Site Specific

2.1.11. Rates of Change of Active Power Output

Non-exhaustive Requirement Taking into consideration the specific characteristics of the prime mover technology:
Minimum limit of change of active power output in down direction
Maximum limit of change of active power output in down direction
Minimum limit of change of active power output in up direction
Maximum limit of change of active power output in up direction

Articles 15(6)(e) According to the Article 15(6)(e) of **Transposed network code on requirements for grid connection of generators** type C and D power-generating module shall fulfil requirements follow requirements regard to limits of change of active power output:

- a) Minimum limit of change of active power output in down direction: 1%Pmax/minute
- b) Maximum limit of change of active power output in down direction: 20%Pmax/minute
- c) Minimum limit of change of active power output in up direction: 1%Pmax/minute

- d) Maximum limit of change of active power output in up direction: 20
%Pmax/minute

Applicability: Type C and D

Mandatory

General

2.2. Voltage Issues

2.2.1. Voltage Ranges

	Time period for operation within voltage range at connection point 1.118 pu - 1.15 pu
Non-exhaustive Requirement	Time period for operation within voltage range at connection point 1.05pu-1.10pu Shorter time period in the event of simultaneous overvoltage/undervoltage and underfrequency/overfrequency
Articles 16.2(a):	In addition to the Article 16(2)(a)(i), Table 6.1 and Table 6.2 of Transposed network code on requirements for grid connection of generators type D power-generating modules shall be capable of staying connected to the network and operating for the time period and voltage range at the connection point as follows: <ul style="list-style-type: none"> a) For 110 kV network: Voltage range 1.118 pu - 1.15 pu: 20 minutes* b) For 300 kV and 400 kV networks: Voltage range 1.097 pu - 1.15 pu: 20 minutes*
Applicability:	Type D PGMs
Mandatory/Non-Mandatory 16.2(a)(ii)	
Dependencies:	Frequency ranges
<i>*These ranges are defined in Decision 2018/05/PHLG-EnC but not in Decision 2018/03/PHLG-EnC</i>	
Non-exhaustive Requirement	Wider voltage ranges
Articles 16.2(b):	According to the Article 16(2)(b) of Transposed network code on requirements for grid connection of generators , power generating facility owner and relevant system operator will agree on wider voltage ranges or longer minimum time periods than the ones defined in previous paragraph during the connection process in due time for plant design. If economically and technically feasible, the power-generating facility owner shall not unreasonably withhold an agreement.
Applicability:	Type D PGMs
Non-mandatory	
Site specific	

2.2.2. Fault ride through capability

Non-exhaustive Requirement	Required FRT profile for symmetrical and asymmetrical faults: <i>Uret, Uclear, Urec1, Urec2, tclear, trec1, trec2, trec3</i> Pre- and post-fault conditions
Articles 14.3:	In addition to the Article 14(3)(a)(i), Figure 3 and Table 3.1 and Article 14(3)(b)(i) of Transposed network code on requirements for grid connection of generators , for synchronous power generating modules of type B, C and D connected to network with nominal voltage below 110 kV, voltage-against-time profile for symmetrical and asymmetrical faults in power system is determined by the following figure

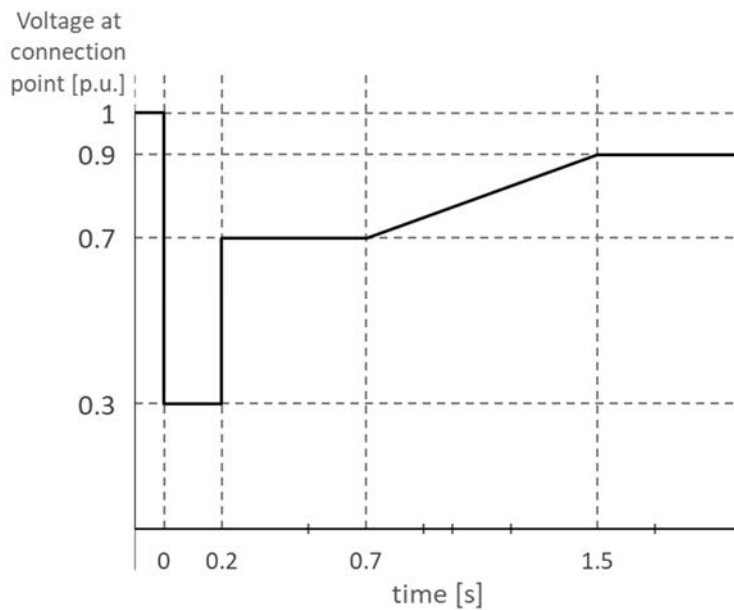

In the case of asymmetrical faults voltage-against-time profile applies to the phase with lowest voltage value during the fault.

According to the Article 14(3)(a)(iv) of **Transposed network code on requirements for grid connection of generators** transmission system operator will provide to the power generating facility owner the pre-fault and post-fault conditions for the fault-ride through capability in terms of: pre-fault minimum short circuit capacity at the connection point, pre-fault active and reactive power operating point of the power-generating module at the connection point and voltage at the connection point, and the post-fault minimum short circuit capacity at the connection point, upon the request of the interested power generating facility owner.

In addition to the Article 14(3)(a)(vi), Figure 3 and Table 3.2 and Article 14(3)(b)(i) of **Transposed network code on requirements for grid connection of generators**, for power park modules of type B, C and D connected to network with nominal voltage below 110 kV, voltage-against-time profile for symmetrical and asymmetrical faults in power system is determined by the following figure

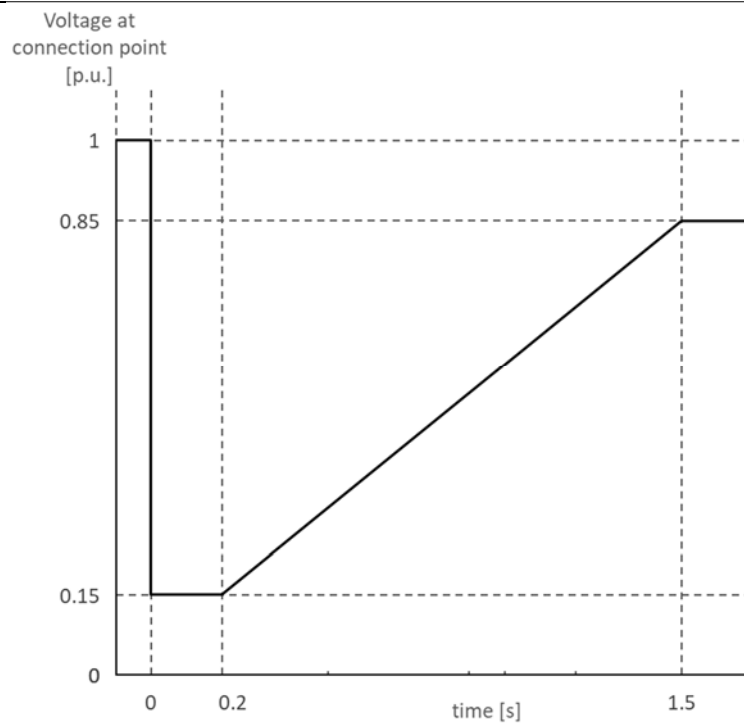

In the case of asymmetrical faults voltage-against-time profile applies to the phase with lowest voltage value during the fault.

Applicability: Type B, C, D PGMs connected below 110 kV

Mandatory

Dependencies: *Determination of significance*

Non-exhaustive Requirement Required FRT profile for symmetrical and asymmetrical faults:

Uret, Uclear, Urec1, Urec2, tclear, trec1, trec2, trec3

Pre- and post-fault conditions

Articles 16.3: In addition to the Article 16(3)(a)(i), Figure 3 and Table 7.1 and Article 16(3)(c) of **Transposed network code on requirements for grid connection of generators**, for synchronous power generating modules of D connected to network with nominal voltage at or above 110 kV, voltage-against-time profile for symmetrical and asymmetrical faults in power system is determined by the following figure

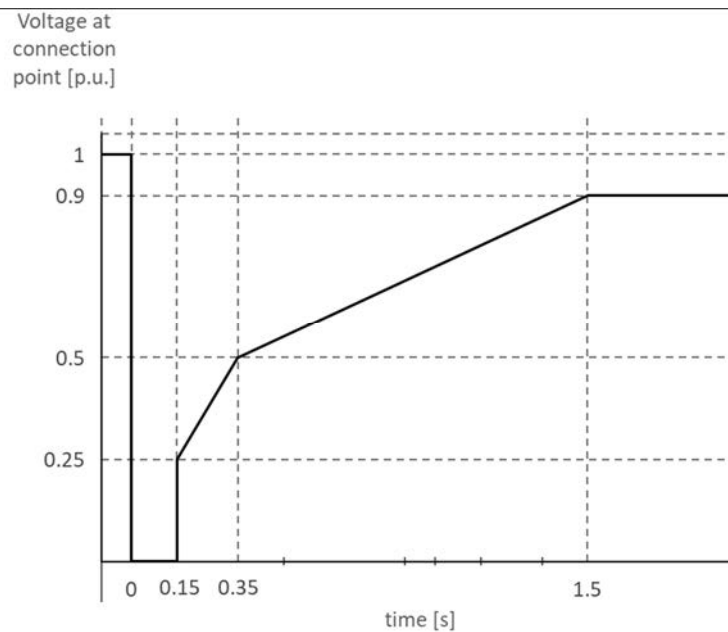

In the case of asymmetrical faults voltage-against-time profile applies to the phase with lowest voltage value during the fault.

According to the Article 16(3)(a)(ii) of **Transposed network code on requirements for grid connection of generators** transmission system operator will provide to the power generating facility owner the pre-fault and post-fault conditions for the fault-ride through capability in terms of: pre-fault minimum short circuit capacity at the connection point, pre-fault active and reactive power operating point of the power-generating module at the connection point and voltage at the connection point, and the post-fault minimum short circuit capacity at the connection point, upon the request of the interested power generating facility owner.

In addition to the Article 16(3)(a)(i), Figure 3 and Table 7.2 and Article 16(3)(c) of **Transposed network code on requirements for grid connection of generators**, for power park modules of type D connected to network with nominal voltage at or above 110 kV, voltage-against-time profile for symmetrical and asymmetrical faults in power system is determined by the following figure

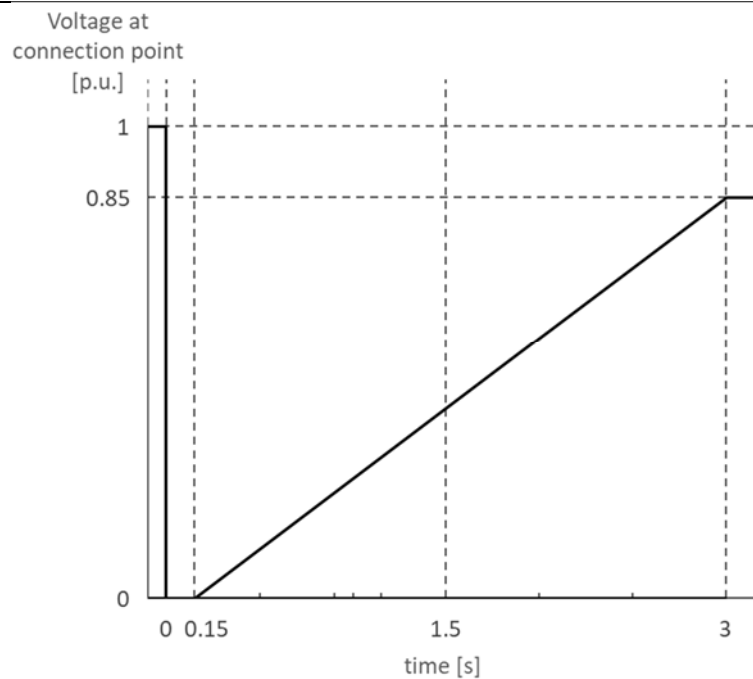

In the case of asymmetrical faults voltage-against-time profile applies to the phase with lowest voltage value during the fault.

Applicability: Type D PGMs

Mandatory

Dependencies: *Determination of significance*

2.2.3. Automatic Disconnection due to Voltage Level

Non-exhaustive Requirement Settings for automatic disconnection of PGMs

Article 15.3: According to the Article 15(3)(a) of **Transposed network code on requirements for grid connection of generators** relevant system operator will specify terms and settings for automatic disconnection of power-generating modules on site specific basis during the connection phase in due time for plant design.

Applicability: Type C, D PGMs

Mandatory

Site specific

Non-exhaustive Requirement Definition of threshold for automatic disconnection

Article 16.2(c): According to the Article 16(2)(c) of **Transposed network code on requirements for grid connection of generators** relevant system operator and power generating facility owner will agree on terms and settings for automatic disconnection of the unit, during the connection phase in due time for plant design.

Applicability: Type C, D PGMs

Non-mandatory

Site specific

2.2.4. Reactive Power Capability

Non-exhaustive Requirement	Reactive power capability
Articles 17.2(a):	According to the Article 17(2)(a) of Transposed network code on requirements for grid connection of generators type B SPGMs shall be designed for operation with power factor values from 0.9 lagging to 0.95 leading at generator terminals at rated active power output.
20.2(a):	According to the Article 20(2)(a) of Transposed network code on requirements for grid connection of generators type B PPMs shall be capable of operating with Q/Pmax range of ± 0.33 at connection point at rated active power output and nominal voltage level at the connection point.
Applicability:	Type B SPGMs (Article 17.2(a)); Type B PPMs (Article 20.2(a))

Non - Mandatory

Dependencies: *Reactive power capability below maximum capacity*

Non-exhaustive Requirement	Reactive power capability at maximum capacity i.e. U-Q/Pmax profile
Article 18.2(b):	In addition to the Article 18(2)(b)(i), Figure 7 and Table 8 of Transposed network code on requirements for grid connection of generators , type C and D synchronous power generating modules will be able to provide reactive power at its maximum capacity according to the following figure

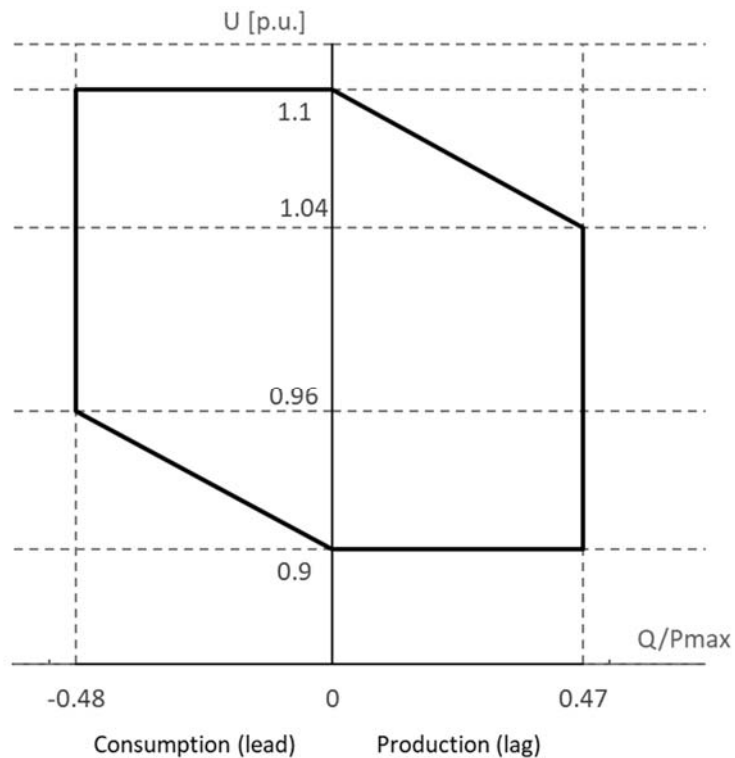

According to the Article 18(2)(b)(iv) of **Transposed network code on requirements for grid connection of generators** type C and D synchronous power generating modules shall be capable of moving to any operating point within define U-Q/Pmax profile with undue delay upon the request of the relevant system operator, but no later than 10 minutes after the request is issued.

Applicability: Type C and D SPGMs

Mandatory

Dependencies: *Reactive power capability below maximum capacity*

Non-exhaustive Requirement Reactive power capability at maximum capacity i.e. U-Q/Pmax profile

Articles 21.3(b): In addition to the Article 21(3)(b)(i), Figure 8 and Table 9 of **Transposed network code on requirements for grid connection of generators**, type C and D power park modules will be able to provide reactive power at its maximum capacity according to the following figure

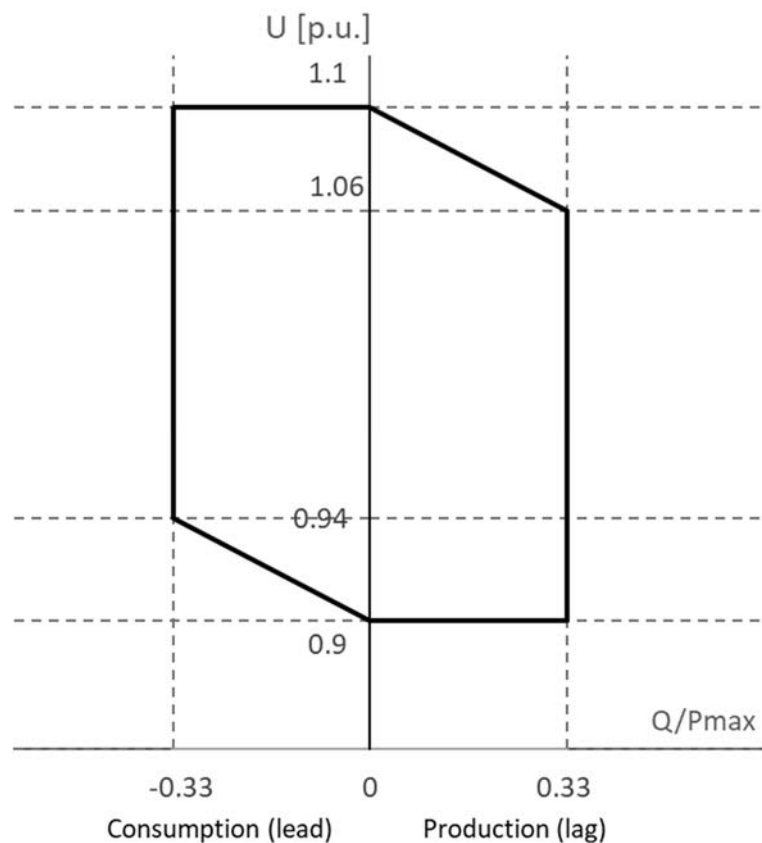

Applicability: Type C and D PPMs

Mandatory

Dependencies: *Reactive power capability below maximum capacity*

2.2.5. Reactive Power Capability below maximum power

Non-exhaustive Requirement Reactive Power Capability below maximum power
Appropriate timescale to reach any operating point within U- Q/Pmax-profile

Articles 21.3(c): In addition to the Article 21(3)(c)(ii) and Figure 9 of **Transposed network code on requirements for grid connection of generators**, type C and D power park modules will be able to provide reactive power below maximum capacity according to the following figure

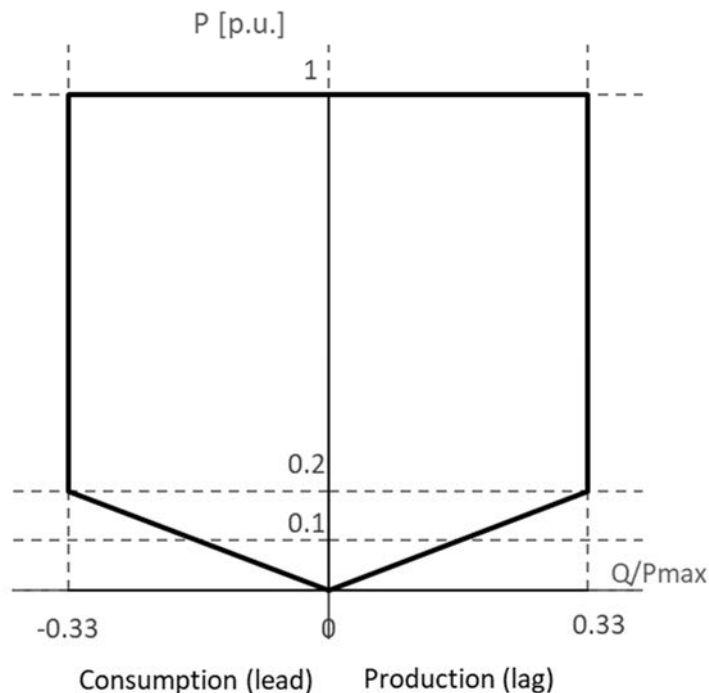

According to the Article 21(3)(c)(iv) of **Transposed network code on requirements for grid connection of generators** type C and D power park modules shall be capable of moving to any operating point within define U-Q/Pmax profile with undue delay upon the request of the relevant system operator, but no later than 10 minutes after the request is issued.

Applicability: Type C and D PPMs

Mandatory

2.2.6. Voltage/Reactive Power Control

2.2.6.1. Voltage Control

Non-exhaustive Requirement Parameters and settings of the AVR
Power threshold for PSS function

Articles

19.2(a): According to the Article 19(2)(a) of **Transposed network code on requirements for grid connection of generators** relevant system operator and power generating facility owner will agree on parameters and settings of the components of the voltage control system, during the connection phase in due time for plant design.

19.2(b): In addition to the Article 19(2)(b)(iv) of **Transposed network code on requirements for grid connection of generators**, voltage control systems of type D synchronous generating modules with maximum capacity above 15 MW will be equipped with PSS function.

Applicability: Type D SPGMs

Mandatory

Site specific

2.2.6.2. Reactive Power Control

Non-exhaustive Requirement

Voltage control mode:
 t1: time within which 90% of the change in reactive power is reached
 t2: time within which 100% of the change in reactive power is reached

Power factor control mode:
 Target power factor
 Time period to reach the set point
 Tolerance

Article 21.3(d): In addition to the Article 21(3)(d)(iv) of **Transposed network code on requirements for grid connection of generators**, following a step change in voltage power park module will achieve reactive power response with rise time $t_1=1$ s and settling time $t_2=5$ s.

In addition to the Article 21(3)(d)(vi) of **Transposed network code on requirements for grid connection of generators**, for the purpose of power factor control mode power par model shall be able to achieve any target power factor within its P-Q/Pmax capability diagram as requested by the relevant system operator, with tolerance of 2% of the maximum reactive power. Following a sudden change active power park module operated in power factor control mode shall achieve target power factor value within 10 s.

Applicability: Type C and D PPMs

Mandatory

Non-exhaustive Requirement Contribution to power oscillations damping

Article 21.3(f): According to the Article 21(3)(f) of **Transposed network code on requirements for grid connection of generators** relevant system operator can specify reasonable request for power park module contribution to power oscillations damping, during the connection phase in due time for plant design.

Applicability: Type C and D PPMs

Non-Mandatory

2.2.7. Fast fault current capability

Non-exhaustive Requirement	Fast fault current capability parameters for symmetrical faults
Article 20.2(b):	N/A
Applicability:	Type B, C and D PPMs
Non-mandatory	
Dependencies:	Synthetic Inertia
Non-exhaustive Requirement	Fast fault current capability parameters for asymmetrical faults
Article 20.2(c):	N/A
Applicability:	Type B, C and D PPMs
Non-mandatory	
Dependencies:	Synthetic Inertia
Non-exhaustive Requirement	Priority to active or reactive power contribution
Article 21.3(e):	N/A
Applicability:	Type B, C and D PPMs
Non-mandatory	
Dependencies:	Synthetic Inertia

2.2.8. Fast fault current capability

**Non-exhaustive
Requirement**

Articles

20.2(b): •

20.2(c):

21.3(e):

Applicability: Type B, C and D PPMs

Non-mandatory

Dependencies: *Synthetic Inertia*

**ENTSO-E
Practice**

2.3. System Restoration Issues

2.3.1. Reconnection Capability

Non-exhaustive Requirement	Conditions for reconnection to the network after an incidental disconnection caused by network disturbance
Articles 14(4)(a)	<p>According to the Article 14(4)(a) of Transposed network code on requirements for grid connection of generators type B, C and D power-generating module shall be capable of reconnecting to the network after an incidental disconnection caused by a network disturbance under the following conditions:</p> <ul style="list-style-type: none"> a) Voltage range: $0.9 \text{ pu} \leq U \leq 1.1 \text{ pu}$; and b) Frequency range: $49.9 \text{ Hz} \leq f \leq 50.05 \text{ Hz}$ c) Minimum observation time: $T_{\text{obs}} = 30 \text{ s} + P_{\text{ref}}/P_{\text{Cmax}} \cdot 300 \text{ s}$, where <ul style="list-style-type: none"> • P_{ref} - Unit rated power; • P_{Cmax} - Maximum power for type C d) Maximum gradient of active power increase $\leq 20\%$ of $P_{\text{max}}/\text{min}$ <p>Reconnection for PGM's type D without the permission of the dispatcher shall be forbidden.</p>
Applicability:	Type B, C and D
Mandatory	
General	
Non-exhaustive Requirement	Conditions for automatic reconnection
Articles 14(4)(b)	<p>According to the Article 14(4)(b) of Transposed network code on requirements for grid connection of generators type B, C and D power-generating module shall be capable of reconnecting to the network after an incidental disconnection caused by a network disturbance under the following conditions:</p> <ul style="list-style-type: none"> a) Voltage range: $0.9 \text{ pu} \leq U \leq 1.1 \text{ pu}$; and b) Frequency range: $49.9 \text{ Hz} \leq f \leq 50.05 \text{ Hz}$ c) Minimum observation time: $T_{\text{obs}} = 30 \text{ s} + P_{\text{ref}}/P_{\text{Cmax}} \cdot 300 \text{ s}$, where <ul style="list-style-type: none"> • P_{ref} - Unit rated power; • P_{Cmax} - Maximum power for type C d) Maximum gradient of active power increase $\leq 20\%$ of $P_{\text{max}}/\text{min}$ <p>Reconnection for PGM's type D without the permission of the dispatcher shall be forbidden.</p>
Applicability:	Type B, C and D
Mandatory	
General	

2.3.2. Blackstart Capability

Non-exhaustive Requirement	Technical specifications for a quotation for black start capability
Articles 15(5)(a)(ii)	<p>According to the Article 15(5)(a)(ii) of Transposed network code on requirements for grid connection of generators type C and D power-generating module shall, at the request of the relevant TSO, provide follow technical data:</p> <ul style="list-style-type: none"> a) capability of starting from shutdown without any external electrical energy supply, b) capability of starting from shutdown to idle mode in 10 minutes c) capability to synchronize on a system whose voltage is equal to zero, d) capability to operate in speed control mode after synchronization, e) capability to operate in speed control mode within extended frequency and voltage ranges, f) capability of parallel operation of a few power-generating modules within one island (manually switch load and speed control mode), g) control voltage automatically during the system restoration phase, h) wider range of generators voltage setpoint, 0.9-1.05 Un, and i) maximum idle duration
Applicability:	Type C and D
Non - Mandatory	
General	
•	
Non-exhaustive Requirement	Timeframe within which the PGM is capable of starting from shutdown without any external electrical energy supply
Articles 15(5)(a)(iii)	<p>According to the Article 15(5)(a)(iii) of Transposed network code on requirements for grid connection of generators type C and D power-generating module shall be capable of starting from shutdown without any external electrical energy supply within a time frame of 10 minutes.</p>
Applicability:	Type C and D
Non - Mandatory	
General	
Non-exhaustive Requirement	Voltage limits for synchronization when article 16.2 does not apply
Articles 15(5)(a)(iv)	<p>According to the Article 15(5)(a), Article 13(1) and Article 16(2) of Transposed network code on requirements for grid connection of generators type C and D power-generating module shall be able to synchronize within the follow voltage and voltage limits:</p> <ul style="list-style-type: none"> a) underutilized network b) - 15%/+10% of rated voltage
Applicability:	Type C and D

Non - Mandatory

General

2.3.3. Capability of Island Operation

Non-exhaustive Requirement Capability of island operation

N/A

Articles 15(5)(b)

Applicability: Type C and D

Non - Mandatory

Site specific

Non-exhaustive Requirement Definition of quality of supply parameters

Articles 15(5)(b)(i) According to the Article 15(5)(b)(i), Article 13(1), Article 15(3) and Article 16(2) of **Transposed network code on requirements for grid connection of generators** type C and D power-generating module shall be capable of taking part in island operation without new voltage and frequency limits. Voltage and frequency limits shall be within standard defined ranges.

Applicability: Type C and D

Non - Mandatory

Site specific

Non-exhaustive Requirement Methods and criteria for detecting island operation

According to the Article 15(5)(b)(iii) of **Transposed network code on requirements for grid connection of generators** type C and D power-generating module shall use follow method for detecting a change from interconnected system operation to island operation (two out of three conditions should be fulfilled):

- Articles 15(5)(b)(iii)**
- a) RoCoF is above define value (+1.5 Hz/s, -2 Hz/s) in two algorithm cycle times;
 - b) Turbine speed/frequency is above 2% of rated speed or speed/frequency is less than 2% of rated speed;
 - c) At least one of switches which separates PGM from the transmission network is open

Applicability: Type C and D

Non - Mandatory

Site specific

2.3.4. Operation following Tripping to Houseload

Non-exhaustive Requirement Provision of quick re-synchronisation capability

Articles 15(5)(c)(i) According to the Article 15(5)(c)(i) of **Transposed network code on requirements for grid connection of generators** type C and D power-generating module shall be capable of quick re-synchronization within 30 minutes.

Applicability: Type C and D

Non - Mandatory

General

Non-exhaustive Requirement Minimum operation time within which the PGM is capable of operating after tripping

Articles 15(5)(c)(iii) According to the Article 15(5)(c)(iii) of **Transposed network code on requirements for grid connection of generators** type C and D power-generating module shall be capable of continuing operation following tripping to houseload, irrespective of any auxiliary connection to the external network in the minimum operation time of 60 minutes.

Applicability: Type C and D

Mandatory

General

2.3.5. Active Power Recovery SPM

Non-exhaustive Requirement	Definition of the magnitude and time for active power recovery
Articles 17(3)	According to the Article 17(3)) of Transposed network code on requirements for grid connection of generators type B, C and D power-generating module shall be capable of providing post-fault active power recovery: a) Magnitude: 90 % b) In tTime: 5 s of pre-fault active power output.
Applicability:	Type B, C and D
Mandatory	
General	

2.3.6. Post Fault Active Power Recovery PPM

Non-exhaustive Requirement	Specification when the post- fault active power recovery begins Specification of the max. allowed time for active power recovery Specification of magnitude and accuracy for active power recovery
Articles 20(3)(a)	According to the Article 17(3)) of Transposed network code on requirements for grid connection of generators type B, C and D of power park modules shall fulfil the following additional requirements in relation to robustness: a) the-post fault active power begins, at a voltage level of 80 % pre fault voltage b) the maximum allowed time 1s, c) the magnitude for active power recovery may be adopted on the level of 80 % of pre-fault active power; d) accuracy for active power recovery – 10% of pre -fault active power.
Applicability:	Type B, C and D
Mandatory	
General	

2.4. Instrumentation, Simulation Models and Protections Issues

2.4.1. Control and Protection Scheme and Settings

Non-exhaustive Requirement Control schemes
Settings of the control devices

Articles 14.5(a): According to the Article 14(5)(a) of **Transposed network code on requirements for grid connection of generators** power generator facility owner and transmission system operator will agree on control schemes, settings and their coordination, during the connection phase in due time for plant design.

Applicability: Type B, C and D PGMs

Mandatory

Site specific

Non-exhaustive Requirement Electrical protection schemes
Electrical protection settings

14.5(b): According to the Article 14(5)(b) of **Transposed network code on requirements for grid connection of generators** power generator facility owner and transmission system operator will agree on protection schemes, settings and their coordination, during the connection phase in due time for plant design.

Applicability: Type B, C and D PGMs

Mandatory

Site specific

2.4.2. Instrumentation

Non-exhaustive Requirement Settings of the fault recording equipment
Triggering criteria of the fault recording equipment
Sampling rates of the fault recording equipment
Specifications of the oscillation trigger
Protocols for recorded data

Articles 15(6)(b)(i-iv) In addition to the Article 15(6)(b) of **Transposed network code on requirements for grid connection of generators** power generator facility owner and relevant system operator will agree on fault recording equipment settings, and the procedure and communication protocols used for recorded data exchange, during the connection process in due time for plant design. Sampling rate of installed fault recorders should be at least 1 kHz.

Applicability: Type C and D PGMs

Non-mandatory/mandatory

Site specific

2.4.3. Simulation models

Non-exhaustive Requirement	Provision of simulation models
	Specifications of the simulation models
	Recordings of PGM performance
Article 15.6(c):	According to the Article 15(6)(c) of Transposed network code on requirements for grid connection of generators power generator facility owner shall provide simulation models according to the requirements set in Appendix X*.
Applicability:	Type C and D PGMs
Non-mandatory	

*As proposed in methodology it is strongly recommended to clearly define in depth all the requirements related to the simulation models based on current practice, used software tools etc. This should be defined as an appendix to the grid code (see methodology for reference to exemplary implementation). Definition of such In depth specification of the simulation models is beyond the scope of the project.

2.4.4. Information exchange

Non-exhaustive Requirement	Content of information exchange
	Precise list of data to be facilitated
	Precise time of data to be facilitated
Article 14(5)(d)(i)(ii)	According to the <i>the</i> Article 15(5)(d) of Transposed network code on requirements for grid connection of generators power generating facility owners of type B, C or D power generating modules shall provide the TSO, in real-time, at least the following data: <ul style="list-style-type: none"> (a) position of the circuit breakers at the connection point or another point of interaction agreed with the TSO; (b) active and reactive power at the connection point or another point of interaction agreed with the TSO; and (c) in the case of power generating facility with consumption other than auxiliary consumption net active and reactive power. Transmission system operator will specify time interval for real time data exchange and communication protocols to be used on site specific basis during the connection phase in due time for plant design.
Applicability:	Type B,C and D PGMs
Mandatory	
Site specific	

2.4.5. Disconnection from grid caused by angular instability or loss of control

Non-exhaustive Requirement	Criteria to detect loss of angular stability or loss of control
Article 15.6(a):	In addition to the Article 15(6)(a) of Transposed network code on requirements for grid connection of generators relevant system operator and power

generating facility owner shall agree on the criteria for detecting loss of angular stability during the connection process in due time for plant design.

Applicability: Type C and D PGMs

Mandatory

Site specific

Dependencies: **Control and Protection Scheme and Settings**

2.4.6. Additional devices to be installed in power generating facility in order to preserve or restore system operation or security

Non-exhaustive Requirement Definitions of the devices needed for system operation and system security

Articles 15.6(d): According to the Article 15(6)(d) of **Transposed network code on requirements for grid connection of generators** if proven necessary relevant system operator and power generating facility owner shall agree on installment of additional devices in a power-generating facility in order to preserve or restore system operation or security during the connection process in due time for plant design.

Applicability: Type C and D PGMs

Mandatory

Site specific

Dependencies: Control and Protection Scheme and Settings.

2.4.7. Step up transformer HV side neutral point earthing type

Non-exhaustive Requirement Neutral point earthing

Article 15.6(f): According to the Article 15(6)(f) of **Transposed network code on requirements for grid connection of generators** relevant system operator shall define earthing arrangement for neutral point of the network side of step-up transformer during the connection process in due time for plant design.

Applicability: Type C and D PGMs

Mandatory

Site specific

2.4.8. Synchronization device

Non-exhaustive Requirement Settings of the synchronisation devices

Article 16.4(d): In addition to the Article 16(4)(d), of **Transposed network code on requirements for grid connection of generators** type D power-generating modules shall be at least capable for synchronization to the network if:

- a) Breaker closing difference i.e. phase difference is $\pm 10\%$

- b) Difference between generator side voltage and voltage at the connection point i.e. voltage difference is between 0% ÷ 5%
- c) Frequency difference between generator side voltage and voltage at the connection point is $\pm 0.067\text{Hz}$

Relevant system operator and power generating facility owner shall agree on settings of synchronization device during the connection phase in due time for plant design.

Applicability: Type D PGMs

Mandatory

Site specific

2.4.9. Angular stability

Non-exhaustive Requirement Agreement for angular stability aid

Article 19.3: According to the Article 15(3)(a) of **Transposed network code on requirements for grid connection of generators** transmission system operator and power generating facility owner shall enter into agreement regarding power-generating module aid to angular stability under fault conditions. If economically and technically feasible, the power-generating facility owner shall not unreasonably withhold an agreement.

Applicability: Type D PGMs

Mandatory

Site specific

Dependencies: **Voltage control**

2.4.10. Synthetic inertia

Non-exhaustive Requirement Definition of the operating principle of control systems to provide synthetic inertia
Related performance parameters to provide synthetic inertia

Article 21.2: N/A

Applicability: Type C and D PPMs

Non-mandatory

General

Dependencies: **RoCoF**

3. Provisions of DCC Non-Exhaustive Requirements

3.1. Frequency Issues

3.1.1. Frequency Ranges

- Non-exhaustive Requirements:**
- Time period for:
 - 47.5Hz – 48.5Hz
 - 48.5Hz – 49.0Hz

Article 12(1): In addition to the Article 12(1) and Annex I of **Transposed network code on demand connection**, transmission-connected demand facilities, transmission-connected distribution facilities and distribution systems shall be capable of remaining connected to the network and operating at the following frequency ranges and time periods:

Time periods for corresponding frequency ranges

Frequency range	Time period for operation
47,5 Hz – 48,5 Hz	30 minutes
48,5 Hz – 49,0 Hz	60 minutes
49,0 Hz – 51,0 Hz	Unlimited
51,0 Hz – 51,5 Hz	30 minutes

Applicability: TC DF and TC DS

Mandatory

General

- Non-exhaustive Requirement:**
- Potential wider frequency ranges
 - Potential longer minimum times

Article 12(2): N/A

Applicability: TC DF and TC DS

Non-mandatory

Site specific

3.1.2. Rate of Change of Frequency

- Non-exhaustive Requirement:**
- Rate of change of frequency withstand over a 500ms time period

Article 28(2)(k): N/A

Applicability: TC DF and TC DS offering DR

Non-mandatory

General

3.1.3. Demand Response System Frequency Control

- Non-exhaustive Requirements:**
- For DU connected below 110 kV: definition of the normal operating range;
 - Definition of the frequency ranges for DRS System Frequency Control (SFC);
 - Definition of the maximum frequency deviation to respond;
 - Definition of the rapid detection of frequency system changes;
 - Definition of the response to frequency system changes;
-

Article 29(2)(c): N/A

Article 29(2)(d): N/A

Article 29(2)(e): N/A

Article 29(2)(g): N/A

Applicability: TC DUs offering DR SRC

Non-mandatory

General

3.2. Voltage Issues

3.2.1. Voltage Ranges

- Non-exhaustive Requirements:**
- Time period for:
 - 1,118 pu – 1,15 pu ;
 - Time period for:
 - 1,05 pu – 1,10 pu;

Articles 13(1): In addition to the Article 13(1) and Annex II of **Transposed network code on demand connection**, transmission-connected demand facilities, transmission-connected distribution facilities and transmission-connected distribution systems shall be capable of remaining connected to the network and operating at the following voltage ranges and time periods:

The Minimum time periods during which the TC DF and TC DS must be capable of operating without disconnecting from the network where the voltage base for pu values is at or above 110 kV and up to (not including) 300 kV

Voltage range	Time period for operation
0.9 pu - 1.118 pu	Unlimited
1.118 pu - 1.15 pu	20 minutes

The Minimum time periods during which the TC DF and TC DS must be capable of operating without disconnecting from the network where the voltage base for pu values is from 300 kV to 500 kV (including)

Voltage range	Time period for operation
0.9 pu - 1.097 pu	Unlimited
1.097 pu - 1.15 pu	20 minutes

Applicability: TC DF and TC DS

Mandatory

General

- Non-exhaustive Requirement:**
- Voltage range at the connection point (below 110 kV) that the TC DS shall be designed to withstand;

Articles 13(7): In addition to the Article 13(7) of Transposed network code on demand connection, transmission-connected distribution systems with a voltage below 110 kV at the connection point shall be designed to withstand the voltage range defined by EN 50160 standard. DSOs shall design the capability of their equipment, connected at the same voltage as the voltage of the connection point to the transmission system, to comply with this voltage range.

Applicability: TC DS

Mandatory

General

3.2.2. Automatic Disconnection Due to Voltage Level

Non-exhaustive Requirements	<ul style="list-style-type: none"> • Voltage criteria parameters at the connection point for automatic disconnection; • Technical parameters at the connection point for automatic disconnection;
Article 13(6):	N/A
Applicability:	TC DF and TC DS
Non-mandatory	
Site specific	

3.2.3. Reactive power capability for TC DF and TC DS

Non-exhaustive Requirement:	<ul style="list-style-type: none"> • Definition of the actual reactive power range for DF without onsite generation
Article 15(1)(a):	<p>In addition to the Article 15(1)(a) of Transposed network code on demand connection, transmission-connected demand facilities shall be capable of maintaining their steady-state operation at their connection point within a reactive power range in accordance to the following conditions. The actual reactive power range for importing and exporting reactive power shall not be wider than 48 percent of the larger of the maximum import capacity or maximum export capacity (0,9 power factor import or export of active power), except in situations where either technical or financial system benefits are demonstrated, for transmission-connected demand facilities, by the transmission-connected demand facility owner and accepted by the relevant TSO.</p>
Applicability:	TC DF
Mandatory	
General	
Non-exhaustive Requirement:	<ul style="list-style-type: none"> • Definition of the actual reactive power range for DF with onsite generation
Article 15(1)(b):	<p>In addition to the Article 15(1)(b) of Transposed network code on demand connection, transmission-connected distribution systems shall be capable of maintaining their steady-state operation at their connection point within a reactive power range in accordance to the following conditions. The actual reactive power range for importing and exporting reactive power shall not be wider than:</p> <ul style="list-style-type: none"> • 48 percent (i.e. 0,9 power factor) of the larger of the maximum import capability or maximum export capability during reactive power import (consumption); • 48 percent (i.e. 0,9 power factor) of the larger of the maximum import capability or maximum export capability during reactive power export (production);

The exception may be made in situations where either technical or financial system benefits are proved by the relevant TSO and the transmission-connected distribution system operator through joint analysis;

Applicability: TC DS

Mandatory

General

Non-exhaustive Requirement:

- Definition of the scope of the analysis to find the optimal solution for reactive power

According to the Article 15(1)(c) of **Transposed network code on demand connection**, the relevant TSO and the transmission-connected distribution system operator shall agree on the scope of the joint analysis in order to determine the optimal solution for reactive power exchange between their systems when requirements defined in the Article 15(1)(b) of the **Transposed network code on demand connection** are not applicable. The analysis shall be conducted during the connection phases but in due time for facility design. The scope of the analysis shall include at least the following:

Article 15(1)(c):

- T-D interface voltage level, because it will determine the kind of technical solution that can be used at the interface;
- Interaction with power quality parameters;
- Strive for a global technical optimum at minimum cost;
- Avoiding cost shifts from one party to the other unless it is proven that this shift would contribute to the global techno-economical optimum;
- Overall cost of the chosen solution should be minimal for the system (distribution/ transmission/users).

Applicability: TC DS

Mandatory

Site specific

Non-exhaustive Requirement:

- Definition of other metrics than power factor

Article 15(1)(d): N/A

Applicability: TC DF and TC DS

Non-mandatory

General

Non-exhaustive Requirements:

- Reactive power capability for transmission connected distribution systems not to export reactive power at less than 25% of the maximum import capability
- Method to carry out active control the exchange of reactive power at the connection point
- Consideration of TC DS for reactive power management

Article 15(2):	N/A
Article 15(3):	N/A
Article 15(4):	N/A
Applicability:	TC DS
Non-mandatory	
Site specific	

3.2.4. Demand Response Service (DRS)

Non-exhaustive Requirements:	<ul style="list-style-type: none"> • For DF or CDS connected below 110 kV: <ul style="list-style-type: none"> ○ Definition of the normal operating range; • Technical specifications to enable the transfer of information for DR LFDD and Low Voltage; • Demand Disconnection (LVDD), for DR Active Power Control (APC) and DR Reactive Power Control; • Definition of the time period to adjust the power consumption; • Definition of the modalities of notification in case of a modification of the DR capability; • Definition of the ROCOF maximum value;
Article 28(2)(c):	N/A
Article 28(2)(e)(l):	N/A
Article 28(2)(f)(j):	N/A
Article 28(2)(i):	N/A
Article 28(2)(k):	N/A
Applicability:	DUs offering DRS
Non-mandatory	
General	

3.2.5. Power Quality

Non-exhaustive Requirement:	<ul style="list-style-type: none"> • Allocated level of voltage distortion
Article 20:	In addition to the Article 20 of Transposed network code on demand connection , transmission-connected demand facility owners and transmission-connected distribution system operators shall ensure that their connection to the network does not result in a determined level of distortion or fluctuation of the supply voltage on the network, at the connection point. The level of distortion shall not exceed the permissible limits defined in the standards IEC/TR3 61000-3-7 and IEC/TR3 61000-3-6.
Applicability:	TC DF and TC DS
Mandatory	

General

3.3. System Restoration Issues

3.3.1. Short circuit requirements

Non-exhaustive Requirement:	<ul style="list-style-type: none"> • Maximum short circuit current at the connection point to be withstood
Article 14(1):	In addition to the Article 14(1) of Transposed network code on demand connection , the transmission-connected demand facility or the transmission-connected distribution system shall be capable of withstanding at the connection point the rated short circuit current of the transmission network elements. The rated short circuit currents of the transmission network elements for corresponding voltage level shall be specified by the relevant TSO ²⁵ .
Applicability:	TC DF and TC DS
Mandatory	
General	
Non-exhaustive Requirement:	<ul style="list-style-type: none"> • An estimate of the minimum and maximum short- circuit currents to be expected at the connection point as an equivalent of the network
Article 14(2):	In addition to the Article 14(2) of Transposed network code on demand connection , the relevant TSO shall calculate the minimum and maximum short-circuit currents at each point of its transmission system once per year and particularly in the case of deviation from the planned order of the connections to the transmission system. The calculation shall be performed for the winter maximum and the summer minimum taking into account existing and planned transmission connected facilities to be connected at the end of the considered five-year and ten-year period. The short circuit currents shall be calculated for the three-phase and the one-phase short circuit in accordance with IEC 60909 standard. The maximum short circuit currents shall be calculated with the voltage factor 1.1 whereas the minimum short circuit currents shall be calculated with the voltage factor 1. The operation condition to be taken into account in the calculation shall provide the highest possible level of short circuit currents. The model of the transmission system to be used for calculation should include the impact of neighbouring TSO. The results of the calculation, the relevant TSO shall make publicly available.
Applicability:	TC DF and TC DS
Mandatory	
General	

²⁵Exact values of the short circuit currents were not known to the Consultants, therefore they have to be specified by the relevant TSO.

Non-exhaustive Requirement:	<ul style="list-style-type: none"> Unplanned events: threshold of the maximum short circuit current inducing an information from the TSO in case of a change above this threshold
Article 14(3):	<p>According to the Article 14(3) of Transposed network code on demand connection, after an unplanned event, the relevant TSO shall inform the affected transmission-connected demand facility owner or the affected transmission-connected distribution system operator as soon as possible and no later than one week after the unplanned event, of the changes above a threshold for the maximum short-circuit current that the affected transmission-connected demand facility or the affected transmission-connected distribution system shall be able to withstand from the relevant TSO's network in accordance with the Article 14(1) of the Transposed network code on demand connection.</p>
Applicability:	TC DF and TC DS
Mandatory	
General	
Non-exhaustive Requirement:	<ul style="list-style-type: none"> Planned events: threshold of the maximum short circuit current inducing an information from the TSO in case of a change above this threshold
Article 14(5):	<p>According to the Article 14(5) of Transposed network code on demand connection, before a planned event, the relevant TSO shall inform the affected transmission-connected demand facility owner or the affected transmission-connected distribution system operator, as soon as possible and no later than one week before the planned event, of the changes above a threshold for the maximum short-circuit current that the affected transmission-connected demand facility or the affected transmission-connected distribution system shall be able to withstand from the relevant TSO's network, in accordance with the Article 14(1) of the Transposed network code on demand connection.</p>
Applicability:	TC DF and TC DS
Mandatory	
General	
Non-exhaustive Requirement:	<ul style="list-style-type: none"> Unplanned events: threshold of the maximum short circuit current inducing an information from the TC DF or TC DSO in case of a change above this threshold
Article 14(8):	<p>In addition to the Article 14(8) of Transposed network code on demand connection, after an unplanned event, the transmission-connected demand facility owner or the transmission-connected distribution system operator shall inform the relevant TSO, as soon as possible and no later than one week after the unplanned event of the changes in short-circuit contribution 2 % above the</p>

threshold set in Article 14(1) of **Transposed network code on demand connection**.

Applicability: TC DF and TC DS

Mandatory

General

Non-exhaustive Requirement:

- Planned events: threshold of the maximum short circuit current inducing an information from the TC DF or TC DSO in case of a change above this threshold

Article 14(9): In addition to the Article 14(9) of **Transposed network code on demand connection**, before a planned event, the transmission-connected demand facility owner or the transmission-connected distribution system operator shall inform the relevant TSO, as soon as possible and no later than one week before the planned event of the changes in short-circuit contribution 2 % above the threshold set in Article 14(1) of **Transposed network code on demand connection**.

Applicability: TC DF and TC DS

Mandatory

General

3.3.2. Demand Disconnection for System Defence

3.3.2.1. Low Frequency Demand Disconnection (LFDD)

Non-exhaustive Requirement

- Definition the capabilities of Low Frequency Demand Disconnection (LFDD) scheme

Article 19(1)(a): In addition to the Article 19(1)(a) of **Transposed network code on demand connection**, each transmission-connected distribution system operator and transmission-connected demand facility owner, shall provide capabilities that enable automatic 'low frequency' disconnection of a specified proportion of their demand. The disconnection of the specified proportion of demand shall be stepwise depending on defined frequency thresholds, whereby the number of steps shall be from 1 to 10 in the frequency range from 49 Hz to 48 Hz. The proportion of demand, the number of the steps and the frequency thresholds shall be agreed between the relevant TSO and the owner/operator of the TC facility during the process of the issuing technical condition for the connection. The proportion of demand, the number of the steps and the frequency thresholds shall be specified in such manner that the share of the load of the TC DF or TC DS in the total national load is fitted in the current LFDD schema. When defining the proportion of demand to be disconnected, the relevant TSO shall take into account:

- The amount of demand that can be disconnected by opening one circuit breaker in particular TC facility;
- The characteristics of demand;
- The critical loads;
- Priority of the customers.

In the case of the TC DS with onsite production, the shift of the under-frequency relays to lower voltage levels shall be considered and if necessary agreed between the relevant TSO and the TC DS operator.

Article 19(1)(c):

In addition to the Article 19(1)(c) of **Transposed network code on demand connection**, the under-frequency disconnection of loads shall be based on the measurement of the system frequency at the connection point and the disconnection shall meet the following requirements:

- The conditions triggering the disconnection shall be possible to be set at 0.05 Hz intervals in the frequency range 47.0–50.0 Hz.
 - The disconnection time of the load shall be no more than 150 ms when the frequency's setpoint value is achieved.
 - The disconnection shall have a voltage lock-out function, which prevents disconnection at under-frequency when the voltage measured by the relay is within range of 0.30–0.90 pu.
 - the protection relay function shall include the ability to report the direction of the flow of active power at the disconnection point.
-

Applicability: TC DF and TC DS

Mandatory

General

3.3.2.2. Low Voltage Demand Disconnection (LVDD) Scheme

Non-exhaustive Requirement:	<ul style="list-style-type: none"> • Definition of the LVDD scheme
Article 19(2)(a):	N/A
Article 19(2)(b):	N/A
Applicability:	TC DF and TC DS
Non-mandatory	
General	
Non-exhaustive Requirements:	<ul style="list-style-type: none"> • Implementation of on load tap changer blocking and low voltage demand disconnection • Equipment for both on load tap changer blocking and low voltage demand disconnection coordination
Article 19(2)(c):	N/A
Article 19(2)(d):	N/A
Applicability:	TC DF and TC DS
Non-mandatory	
Site specific	
Non-exhaustive Requirements:	<ul style="list-style-type: none"> • Requirement of automatic or manual on load tap changer blocking • Definition of the automatic on load tap changer blocking scheme
Article 19(3)(a):	N/A
Article 19(3)(b):	N/A
Applicability:	TC DF and TC DS
Non-mandatory	
Site specific	

3.3.2.3. Conditions for Reconnection and Disconnection

Non-exhaustive Requirement:	<ul style="list-style-type: none"> • Definition of the conditions for reconnection after a disconnection
Article 19(4)(a):	In addition to the Article 19(4)(a) of Transposed network code on demand connection , a transmission-connected demand facility or a transmission-

connected distribution system shall be entitled to reconnect to the transmission system after a disconnection due to disturbance under the following conditions:

- The permission for reconnection is given by the relevant TSO;
- Frequency and voltage at the connection point are in nominal operation ranges.

Automatic reconnection is not allowed, except after disconnection due to the one phase short circuit.

Applicability: TC DF and TC DS

Mandatory

General

Non-exhaustive Requirement:

- Settings of the synchronisation devices (including frequency, voltage, phase angle range and deviation of voltage and frequency)

Article 19(4)(b): According to the Article 19(4)(b) of **Transposed network code on demand connection**, the transmission-connected demand facility or the transmission-connected distribution system shall be capable of synchronisation for frequencies within the ranges set out in Article 12 of the **Transposed network code on demand connection**. The relevant TSO and the transmission-connected demand facility owner or the transmission-connected distribution system operator shall agree on the settings of synchronisation devices during the connection phase but in due time for the facility design. The agreement on the settings of synchronisation devices shall include voltage, frequency, phase angle ranges and deviation of voltage and frequency;

Applicability: TC DF and TC DS

Mandatory

Site specific

Non-exhaustive Requirements:

- Definition of the automated disconnection equipment
- Time for remote disconnection

Article 19(4)(c): N/A

Applicability: TC DF and TC DS

Non-mandatory

General

3.4. Instrumentation, Simulation Models and Protections Issues

3.4.1. Electrical Protection Scheme and Settings

- Non-exhaustive Requirements:**
- Electrical protection schemes
 - Electrical protection settings

Article 16(1): According to the Article 16(1) of **Transposed network code on demand connection**, the relevant TSO shall specify the devices and settings required to protect the transmission network in accordance with the characteristics of the transmission-connected demand facility or the transmission-connected distribution system. The devices and settings shall be specified during the connection phase, but in due time for the facility design. The relevant TSO and the transmission-connected demand facility owner or the transmission-connected distribution system operator shall agree on protection schemes and settings relevant for the transmission-connected demand facility or the transmission-connected distribution system. The agreement shall be achieved during the connection phase, but in due time for the facility design.

Applicability: TC DF and TC DS

Mandatory

Site specific

3.4.2. Control Requirements

- Non-exhaustive Requirements:**
- Control devices schemes
 - Control devices settings

Article 17(1): According to the Article 17(1) of **Transposed network code on demand connection**, the relevant TSO and the transmission-connected demand facility owner or the transmission-connected distribution system operator shall agree on the schemes and settings of the different control devices of the transmission-connected demand facility or the transmission-connected distribution system relevant for system security. The agreement shall be achieved during the connection phase, but in due time for the facility design.

Applicability: TC DF and TC DS

Mandatory

Site specific

3.4.3. Information Exchanges

- Non-exhaustive Requirements:**
- Standards to exchange information and time stamping

Article 18(1): In addition to the Article 18(1) of **Transposed network code on demand connection**, transmission-connected demand facilities shall be equipped such

that they are capable of exchanging real time information with the relevant TSO with the following update interval:

- Measurements: at least 60 s or more frequently
- Commands shall be transferred as fast as possible i.e. with delay which is less than 10 s

The scheduled data shall be provided through intraday and dayahead market process with time stamping defined by these market processes. The structural data shall be provided during the process of issuing the technical conditions for the connection and they shall be update at least every 6 mounts.

Applicability: TC DF

Mandatory

General

Non-exhaustive Requirements:

- Standards to exchange information and time stamping
-

In addition to the Article 18(2) of **Transposed network code on demand connection**, transmission-connected distribution systems shall be equipped such that they are capable of exchanging real time information with the relevant TSO with the following update interval:

Article 18(2):

- Measurements: at least 60 s or more frequently
- Commands shall be transferred as fast as possible i.e. with delay which is less than 10 s

The structural data shall be provided during the process of issuing the technical conditions for the connection and they shall be update at least every 6 mounts.

Applicability: TC DS

Mandatory

General

Non-exhaustive Requirements:

- Make information exchange standards publically available
-

Article 18(3): In addition to the Article 18(3) of **Transposed network code on demand connection**, the transmission-connected demand facilities and the transmission-connected distribution systems shall be equipped with telecommunication

devices that allow data to be exchanged according to the protocols set out in the standards: IEC60870-6(ICCP/TASE.2), IEC 60870-5-104 and IEC 60870-5-101²⁶.

Each transmission-connected demand facility owner shall provide at least the following structural data to the TSO:

- Electrical data of the transformers connected to the transmission system;
- Characteristics of the load of the demand facility;
- Characteristics of the reactive power control.

Each transmission-connected demand facility owner shall provide at least the following scheduled data to the relevant TSO:

- Scheduled active and forecasted reactive power consumption on a day-ahead and intraday basis, including any changes of those schedules or forecast;
- Any forecasted restriction in the reactive power control capability;
- In case of participation in demand response, a schedule of its structural minimum and maximum power range to be curtailed
- By exception to the first point, in regions with a central dispatch system, the data requested by the relevant TSO for the preparation of its active power output schedule.

Each transmission-connected demand facility owner shall provide at least the following data to the relevant TSO in real-time:

- The actual substation topology;
- The tap positions of transformers connected to the transmission system;
- The bus bar voltages;
- The reactive power in reactor and capacitor bay;
- Active and reactive power at the connection point;
- The minimum and maximum power range to be curtailed.

The relevant TSO may require additional data to be exchanged in real time. The additional data shall be specified during the process of issuing technical conditions for the connection but in due time for TC DF design.

Each transmission-connected distribution system operator shall provide at least the following structural data to the TSO:

- Substations by voltage and topology of each substation;
- Power lines that connect the substations;
- Data about transformers from the substations;
- Number of the significant grid users connected in DSO's network;
- Data about reactors and capacitors connected to the substations;
- At least once a year, each transmission-connected DSO shall provide the TSO, per primary energy sources, the total aggregated generating capacity of the type A power generating modules and the best possible

²⁶ The relevant TSO may specify some other standards depending on current practice. These standards are Consultants' recommendation.

estimates of generating capacity of type A power generating modules as well as the related information concerning their frequency behaviour.

Each transmission-connected distribution system operator shall provide at least the following data to the relevant TSO in real-time:

- The actual substation topology;
- The active and reactive power in line bay;
- The active and reactive power in transformer bay;
- The active and reactive power injection in power generating facility bay;
- The tap positions of transformers connected to the transmission system;
- The bus-bar voltages;
- The reactive power in reactor and capacitor bay;
- The best available data for aggregated generation per primary energy source in the DSO area;
- The best available data for aggregated demand in the DSO area;

The relevant TSO may require additional data to be exchanged in real time. The additional data shall be specified during the process of issuing technical conditions for the connection but in due time for TC DS design.

Applicability: TC DS and TC DF

Mandatory

General

3.4.4. Simulation Models

Non-exhaustive Requirements:	<ul style="list-style-type: none"> • Requirements for the simulation models or equivalent information • Content and format of the simulation models or equivalent information • Sub-models or equivalent information included in Art. 21.3. • Requirements for the recordings to be compared with the response of the model
-------------------------------------	-----------------------------------------------------------------------------------------------------------------------------------------------------------------------------------------------------------------------------------------------------------------------------------------------------------------------------------------------------------------------

Article 21(2): N/A

Article 21(3): N/A

Article 21(4): N/A

Article 21(5): N/A

Applicability: TC DF and TC DS

Non-mandatory

General

4. References

- [47] European Council. (2018). Commission Regulation (EU) 2016/631 of 14 April 2016 establishing a network code on requirements for grid connection of generators
- [48] European Council. (2018). Commission Regulation (EU) 2016/1388 of 17 August 2016 establishing a Network Code on Demand Connection
- [49] European Council. (2018). Commission Regulation (EU) 2016/1447 of 26 August 2016 establishing a network code on requirements for grid connection of high voltage direct current systems and direct current-connected power park modules
- [50] The Permanent High Level Group of Energy Community. (2018). DECISION No 2018/03/PHLG-EnC OF THE PERMANENT HIGH LEVEL GROUP OF THE ENERGY COMMUNITY of 12 January 2018 on incorporating Commission Regulation (EU) 2016/631 of 14 April 2016 establishing a Network Code on requirements for grid connection of generators in the Energy Community
- [51] The Permanent High Level Group of Energy Community. (2018). DECISION 2018/05/PHLG-EnC OF THE PERMANENT HIGH LEVEL GROUP OF THE ENERGY COMMUNITY of 12 January 2018 on incorporating Commission Regulation (EU) 2016/1388 of 17 August 2016 establishing a Network Code on Demand Connection in the Energy Community
- [52] The Permanent High Level Group of Energy Community. (2018). DECISION No 2018/04/PHLG-EnC OF THE PERMANENT HIGH LEVEL GROUP OF THE ENERGY COMMUNITY of 12 January 2018 on incorporating Commission Regulation (EU) 2016/1447 of 26 August 2016 establishing a network code on requirements for grid connection of high voltage direct current systems and direct current connected power park modules in the Energy Community
- [53] ENTSO-E. (2020). Parameters of Non-exhaustive Requirements, ENTSO-E, Guidance document for national implementation for network codes on grid connection
- [54] ENTSO-E. (2016). Parameters related to voltage issues, ENTSO-E guidance document for national implementation for network codes on grid connection
- [55] ENTSO-E. (2016). Reactive power control modes for PPM & HVDC, ENTSO-E guidance document for national implementation for network codes on grid connection
- [56] ENTSO-E. (2016). Reactive power requirement for PPMS & HVDC at low / zero power, ENTSO-E guidance document for national implementation for network codes on grid connection
- [57] ENTSO-E. (2016). Fault current contribution from PPMS & HVDC, ENTSO-E guidance document for national implementation for network codes on grid connection
- [58] ENTSO-E. (2016). Instrumentation, simulation models and protection, ENTSO-E guidance document for national implementation for network codes on grid connection
- [59] ENTSO-E. (2016). Selecting national MW boundaries, ENTSO-E guidance document for national implementation for network codes on grid connection
- [60] ENTSO-E. (2016). Demand Response - System Frequency Control, ENTSO-E guidance document for national implementation for network codes on grid connection
- [61] ENTSO-E. (2016). Reactive power management at T - D interface, ENTSO-E guidance document for national implementation for network codes on grid connection
- [62] ENTSO-E. (2016). Making non-mandatory requirements at European level mandatory at national level, ENTSO-E guidance document for national implementation for network codes on grid connection
- [63] ENTSO-E. (2017). High Penetration of Power Electronic Interfaced Power Sources (HPoPEIPS), ENTSO-E guidance document for national implementation for network codes on grid connection
- [64] ENTSO-E. (2018). Need for synthetic inertia (SI) for frequency regulation, ENTSO-E guidance document for national implementation for network codes on grid connection

- [65] ENTSO-E. (2020). Inertia and Rate of Change of Frequency (RoCoF), Version 17, SPD - Inertia TF
- [66] ENTSO-E. (2017). Fault current contribution from PPMS & HVDC, Draft of expert group FFCI
- [67] ENTSO-E. (2016). Reactive power control modes for PPM & HVDC ENTSO-E guidance document for national implementation for network codes on grid connection
- [68] IEEE. (2014). IEEE Guide for Identification, Testing and Evaluation of the Dynamic Performance of Excitation Control Systems
- [69] P.Kundur. (1994). Power System Stability and Control
- [70] KEMA DNV. (2013). Technical Report on ENTSO-E Network Code: Requirements for Generators
- [71] ENTSO-E. (2016). Reactive power management at T-D interface. ENTSO-E guidance document for national implementation for network codes on grid connection
- [72] Sandia National Laboratories. (2012). Reactive Power Interconnection Requirements for PV and Wind Plants - Recommendations to NERC
- [73] ENTSO-E. (2016). Instrumentation, simulation models and protection. ENTSO-E guidance document for national implementation for network codes on grid connection
- [74] ENERGINET.(2020).APPEDNI X 1.B - REQUIREMETNS FOR GENERATORS (RFG) REQUIREMETNS FOR SIMULATION MODELS
- [75] NETWORK CODE FOR REQUIREMENTS FOR GRID CONNECTION APPLICABLE TO ALL GENERATORS REQUIREMENTS IN THE CONTEXT OF PRESENT PRACTICES, 26.06.2012, WORKING DOCUMENT
- [76] ENTSO-E Rate of Change of Frequency (RoCoF) withstand capability ENTSO-E guidance document for national implementation for network codes on grid connection, 31 January 2018
- [77] Inertia and Rate of Change of Frequency (RoCoF) Version 17, SPD - Inertia TF 16. Dec. 2020
- [78] Frequency Stability Evaluation Criteria for the Synchronous Zone of Continental Europe - Requirements and impacting factors -RG-CE
- [79] System Protection & Dynamics Sub Group March 2016
- [80] Energy Networks Association Loss of Mains Protection Settings for all Small Generators Stakeholder Workshop 15 June 2018, London
- [81] SOGL
- [82] UCTE document "LOAD-FREQUENCY CONTROL AND PERFORMANCE, APPENDIX 1", version 1.9, level E, dated 16.06.2004.
- [83] Frequency Sensitive Mode, ENTSO-E guidance document for national implementation for network codes on grid connection", dated 31 January 2018
- [84] Entso-E Annual load - frequency report, 2019.
- [85] Limited frequency sensitive mode, ENTSO-E guidance document for national implementation for network codes on grid connection, dated on 31 January 2018
- [86] Maximum Admissible active power reduction at low frequencies, ENTSO-E guidance document for national implementation for network codes on grid connection, 31 January 2018
- [87] "Automatic connection/reconnection and admissible rate of change of active power",
- [88] ENTSO-E guidance document for national implementation of conditions for automatic connection / reconnection after incidental disconnection and admissible rate of change of active power, 31 January 2018
- [89] "Parameters related to frequency stability", ENTSO-E guidance document for national implementation for network codes on grid connection, 16 November 2016
- [90] Post-fault active power recovery, ENTSO-E guidance document for national implementation for network codes on grid connection, dated 16 November 2016.
- [91] ENTSO-E. (2010). Technical Background and Recommendations for Defence Plans in the Continental Europe Synchronous Area - LVDD schema
- [92] EirGrid's proposal for the general application of technical requirements in accordance with Articles 12 – 21 & Articles 27 – 30 of the Commission Regulation (EU) 2016/1388 establishing a Network Code on Demand Connection, 20 September 2018

MUTUAL TSO AND DSO CONNECTION ISSUES AND BUSINESS PROCESSES

List of Abbreviations

AVR	- Automatic Voltage Regulator
CDSO	- Closed Distribution System Operator
CNC	- Connection Network Codes
DCC	- Demand Connection Code
DF	- Demand Facility
DS	- Distribution System
DSO	- Distribution System Operator
EnC	- Energy Community
ENTSO-E	- European Network of Transmission System Operators for Electricity
FSM	- Frequency Sensitivity Mode
HVDC	- High Voltage Direct Current
LV	- Low Voltage
NRA	- National Regulatory Authority
PGFO	- Power Generating Facility Owner
PGM	- Power Generating Module
PPM	- Power Park Module
PSS	- Power System Stabilizer
RES	- Renewable Energy Sources
RfG	- Requirements for Generators
RoCoF	- Rate-of-Change-of-Frequency
RSO	- Relevant System Operator
SPGM	- Synchronous Power-Generating Module
SFC	- System Frequency Control
SPGM	- Synchronous Power-Generating Module
TC DF	- Transmission connected Demand Facility
TC DS	- Transmission Connected Distribution System, including Transmission Connected Distribution Facilities
TSO	- Transmission System Operator
LVDD	- Low voltage demand disconnection

Definitions

Closed Distribution System	a distribution system classified as a closed distribution system by national regulatory authorities or by other competent authorities, where so provided by the EnC contracting party, which distributes electricity within a geographically confined industrial, commercial or shared services site and does not supply household customers, without prejudice to incidental use by a small number of households located within the area served by the system and with employment or similar associations with the owner of the system;
Connection point	the interface at which the PGM, demand facility, distribution system or HVDC system is connected to a transmission system, offshore network, distribution system, including closed distribution systems, or HVDC system, as identified in the connection agreement;
Demand facility	a facility which consumes electrical energy and is connected at one or more connection points to the transmission or distribution system. A distribution system and/or auxiliary supplies of a power generating module do not constitute a demand facility;
Demand unit	an indivisible set of installations containing equipment which can be actively controlled by a demand facility owner or by a CDSO, either individually or commonly as part of demand aggregation through a third party;
Grid User	assets/facilities and their owners connected to transmission or distribution networks;
Low Frequency Demand Disconnection	an action where demand is disconnected during a low frequency event in order to recover the balance between demand and generation and restore system frequency to acceptable limits;
Maximum capacity	the maximum continuous active power which a PGM can produce, less any demand associated solely with facilitating the operation of the PGM and not fed into the network as specified in the connection agreement or as agreed between the relevant system operator and the PGFO (usually noted as Pmax);
Maximum Export Capability	the maximum continuous active power that a transmission-connected demand facility or a transmission-connected distribution facility, can feed into the network at the connection point, as specified in the connection agreement or as agreed between the relevant system operator and the transmission-connected demand facility owner or transmission-connected distribution system operator respectively;
Maximum Import Capability	the maximum continuous active power that a transmission-connected demand facility or a transmission-connected distribution facility can consume from the network at the connection point, as specified in the connection agreement or as agreed between the relevant system operator and the transmission-connected demand facility owner or transmission-connected distribution system operator respectively;

closed distribution system	a distribution system classified as a closed distribution system by national regulatory authorities or by other competent authorities, where so provided by the EnC contracting party, which distributes electricity within a geographically confined industrial, commercial or shared services site and does not supply household customers, without prejudice to incidental use by a small number of households located within the area served by the system and with employment or similar associations with the owner of the system;
transmission-connected distribution system'	a distribution system connected to a transmission system, including transmission-connected distribution facilities;
maximum import capability'	the maximum continuous active power that a transmission-connected demand facility or a transmission-connected distribution facility can consume from the network at the connection point, as specified in the connection agreement or as agreed between the relevant system operator and the transmission- connected demand facility owner or transmission-connected distribution system operator respectively;
maximum export capability	the maximum continuous active power that a transmission-connected demand facility or a transmission-connected distribution facility, can feed into the network at the connection point, as specified in the connection agreement or as agreed between the relevant system operator and the transmission- connected demand facility owner or transmission-connected distribution system operator respectively;
low frequency demand disconnection	an action where demand is disconnected during a low frequency event in order to recover the balance between demand and generation and restore system frequency to acceptable limits;

1. Introduction

During the implementation of non-exhaustive requirements TSO and DSO²⁷ will have to closely collaborate. There are a lot of processes and requirements that require RSO i.e. DSO to cooperate or coordinate its activities with the TSO. These processes and requirements, are defined and listed in this report.

It must be noted that in countries where there is more than one DSO, for the purpose of making decisions concerning all DSOs, a grid code governance committee (or similar entity) which would be under NRA's supervision should be established. Representatives of all DSOs, TSO(s), NRA and other interested parties (e.g. PGFOs) should make up this entity. The main tasks of the committee shall be the administration of the DSO's Grid Code i.e. making decisions about amendments of the DSO's Grid Code. The committee should also facilitate and promote collaboration between DSO and TSO regarding all relevant connection issues.

For general requirements DSO and TSO will have to collaborate during the implementation of non-exhaustive parameters. One of the possible solution to achieve this cooperation efficiently is to form a joint task force from TSO's and DSO's personnel in order to consider different aspects and issues that arises from implementation of certain non-exhaustive requirements for connection on distribution/transmission network. On the other hand, for most of the requirements that are site specific the collaboration and coordination between DSO and TSO is going to be necessary during the connection process.

²⁷ Considering that in some countries there is more than one DSO, hereinafter, the singular include the plural and vice versa.

2. Processes

The most important processes that require close cooperation DSO-TSO:

- Determination of significance
- Implementation of non-exhaustive parameters,
- Technical conditions for connection
- Derogation process
- Compliance process
- Process of changing Grid Codes (TSO and DSO)

2.1. Determination of significance

One of the first processes that will require close TSO and DSO cooperation is during the determination of significance, i.e. creating the proposal for type B, C and D PGMs thresholds according to the [47] Article 5. Even though proposal for determination of power thresholds is created by the TSO [47] requires TSO to coordinate its activities with the DSO. This is very important because all of the PGMs except of type D PGMs are going to be connected to the distribution grid (to be precise depending on the defined power threshold some of the type D PGMs can be also connected to the distribution grid). Guidance for determination of power threshold values is given in the Methodology and the process for determination of significance as defined in [47] is presented in Task 5 report. In the following figure graphical representation of the determination of significance process is given.

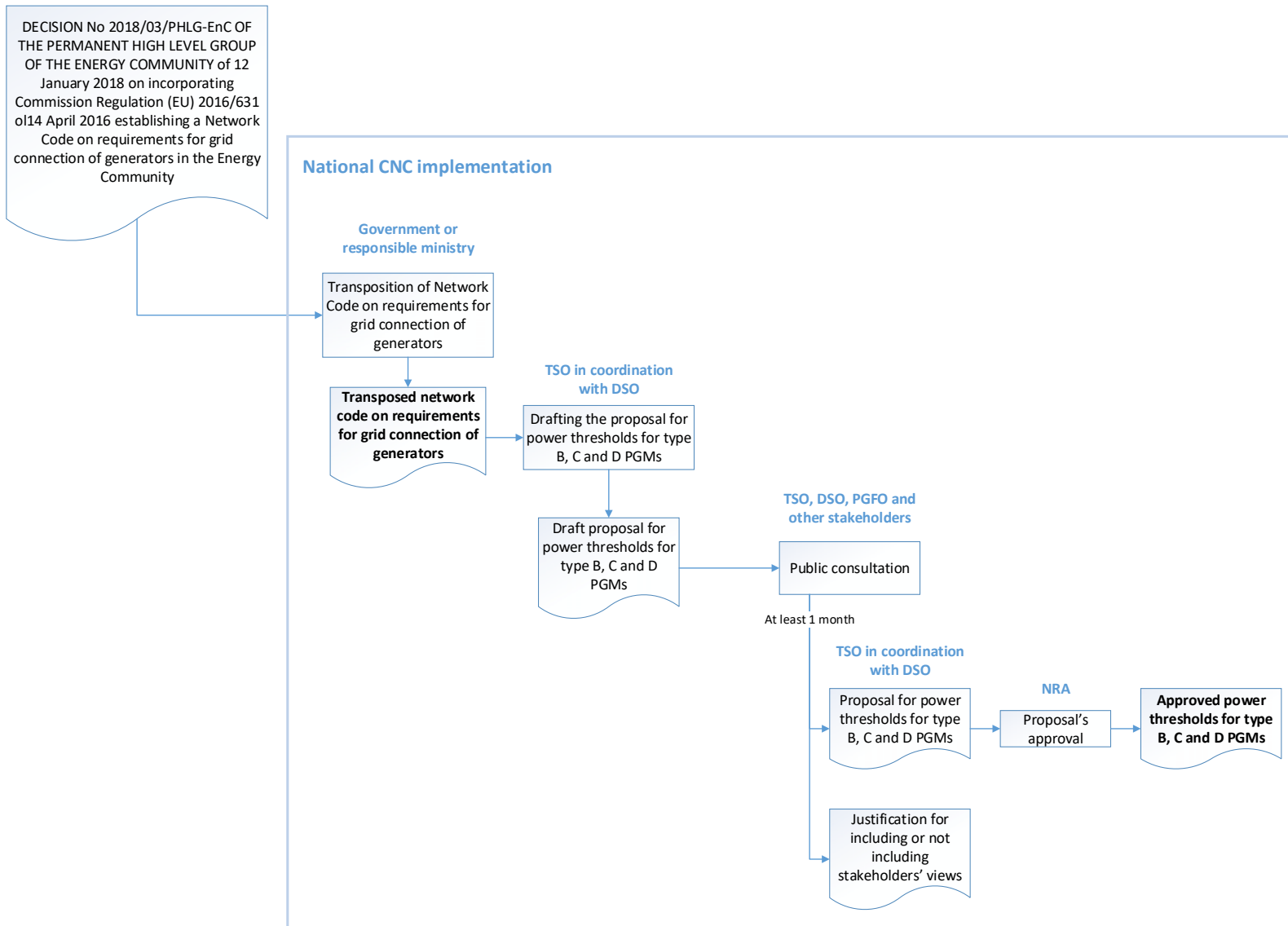

Figure 71 – Determination of significance process

2.2. Implementation of non-exhaustive parameters

After transposition there are two possible ways to implement non-exhaustive requirements. One way is to define new document in form of a bylaw common for both TSO and DSO in which all non-exhaustive parameters are defined (e.g. Connection codes). After the non-exhaustive requirements implementation, the TSO and DSO would have to harmonize Grid Codes with newly adopted connection codes. Having in mind general procedure for non-exhaustive requirements implementation outlined in CNCs, the connection codes would have to be defined by the TSO and DSO in coordination with the NRA with inclusion of PGFOs and other stakeholders when needed. According to [47] Article 7 Paragraph 4 RSO i.e. DSO or TSO shall submit a proposal for requirements of general application, or the methodology used to calculate or establish them unless otherwise provided by the Contracting Party. The decision on proposed requirements or methodology should be issued within six months of the proposal receipt. For site specific requirements that are established by the DSOs and TSOs “Contracting Party may require approval by a designated entity”, but it is not mandatory. At last according to [47] Article 7 Paragraph 9 “Where the requirements under this Regulation are to be established by a relevant system operator that is not a TSO, Contracting Parties may provide that instead the TSO be responsible for establishing the relevant requirements”.

This implementation process, would require changes to the national Energy Law in order to introduce new document (Connection code) into legislation. Merits of this kind of implementation is that it provides stronger and more immediate cooperation between TSO and DSO. Downside is that it requires amendments to the national law on energy to be made which can be time consuming process. Also if implemented in this way it is strongly recommended to define by the law that Connection Codes Governance Committee is to be established. This committee, formed by the representatives of TSO, DSO, PGFOs and NRA, would be responsible for connection code revisions and implementation monitoring.

Another way for implementation of non-exhaustive requirements, would be to define all non-exhaustive parameters in grid codes: DSO grid code and TSO grid code. Merits of this kind of implementation is that it doesn't call for any new bylaws or changes to the existing legislation. Downside is that it is more challenging to achieve strong cooperation and collaboration between TSO and DSO, especially when it comes to harmonization of requirements between codes. Both implementation methods are shown in the figures below.

2.2.1. DSO and TSO coordination during the implementation process of non-exhaustive parameters

Two processes of collaboration, according to the guidelines for non-exhaustive requirements implementation given in [47] and [48], are identified:

- DSO defines technical requirements that will be used on distribution level in cooperation with TSO

The owner of the implementation process is DSO. The non-exhaustive requirement should be defined in coordination with the TSO. In case that the TSO does not agree with the proposed requirement, NRA should act as a mediator, before draft requirement/methodology is submitted for public consultation. The non-exhaustive requirements which DSO defines in cooperation with TSO are identified in the CNCs usually as “RSO in cooperation with TSO shall”.

- TSO defines technical requirement that will be used on distribution level

This is special case of requirements where the requirement is related to the facilities' capabilities to provide services or to have some technical capabilities that are important for system operation in the domain of TSO's responsibilities beyond the scope of DSO (e.g. frequency control). In this case CNCs defines that TSO is the one that specifies non-exhaustive requirement, and thus is the owner of the implementation process. If agreement cannot be achieved between TSO and DSO, NRA should act as a mediator, before draft requirement is submitted for public consultation.

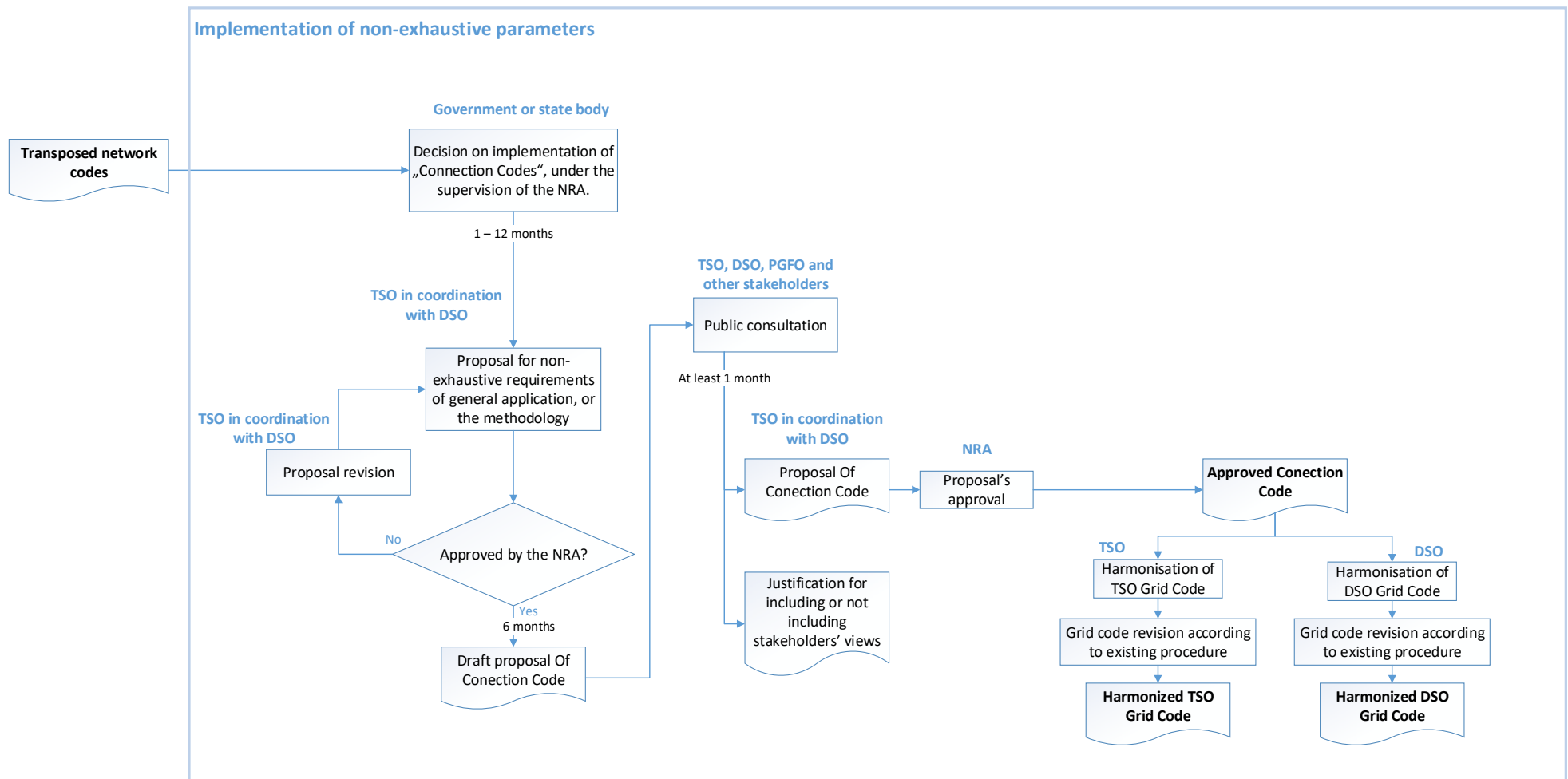

Figure 72 - Implementation of non-exhaustive parameters through newly adopted Connection Code

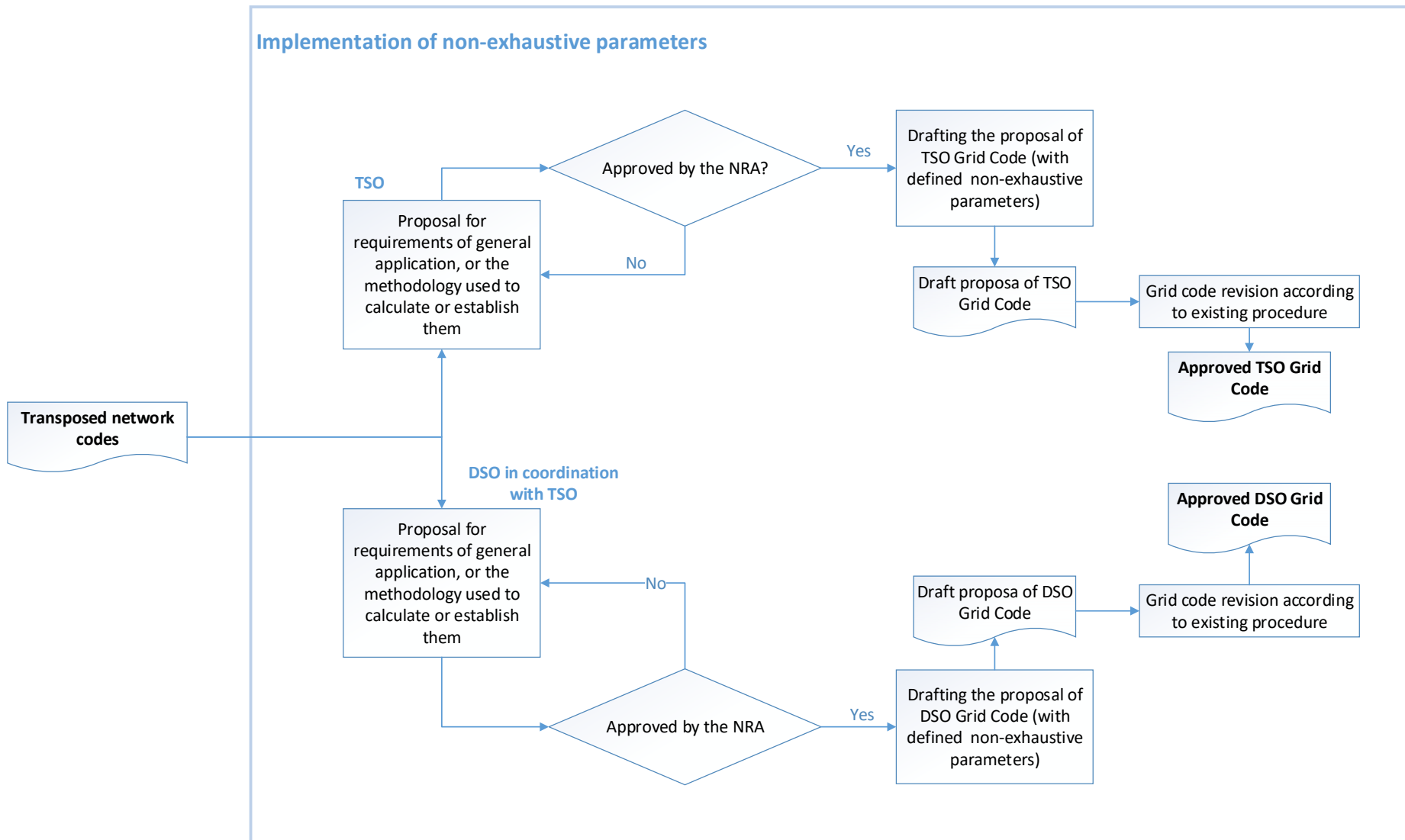

Figure 73 - Implementation of non- exhaustive parameters in existing grid code

2.3. Technical conditions for connection

Two processes of collaboration between TSO and DSO in the domain of technical conditions are identified:

- DSO issues technical conditions for connection;
- Issuing technical conditions for connection of type D PGMs planned to be connected to distribution network in case when the PGM is going to be under TSO control.

In all processes, the connection to the distribution network is assumed. In first two processes PGFO submits request for connection to the DSO, and initiates connection procedure. DSO according to the existing procedure drafts technical conditions for connection according to all the relevant documents and requirements, including newly implemented non-exhaustive requirements. After the technical conditions for connections are drafted, DSO sends these conditions to TSO for approval and/or to define conditions that are under the jurisdiction of TSO. This is mainly important for site specific requirements that are either defined in cooperation between DSO and TSO, or defined by the TSO entirely. If the conditions are site specific, beside cooperation between TSO and DSO in some cases coordination with PGFO is required.

In third process, DSO forwards the issuing technical conditions for connection to the TSO, so the connection process continues as the connection to the transmission system.

Processes of Issuing technical conditions for connection are shown on the figures below.

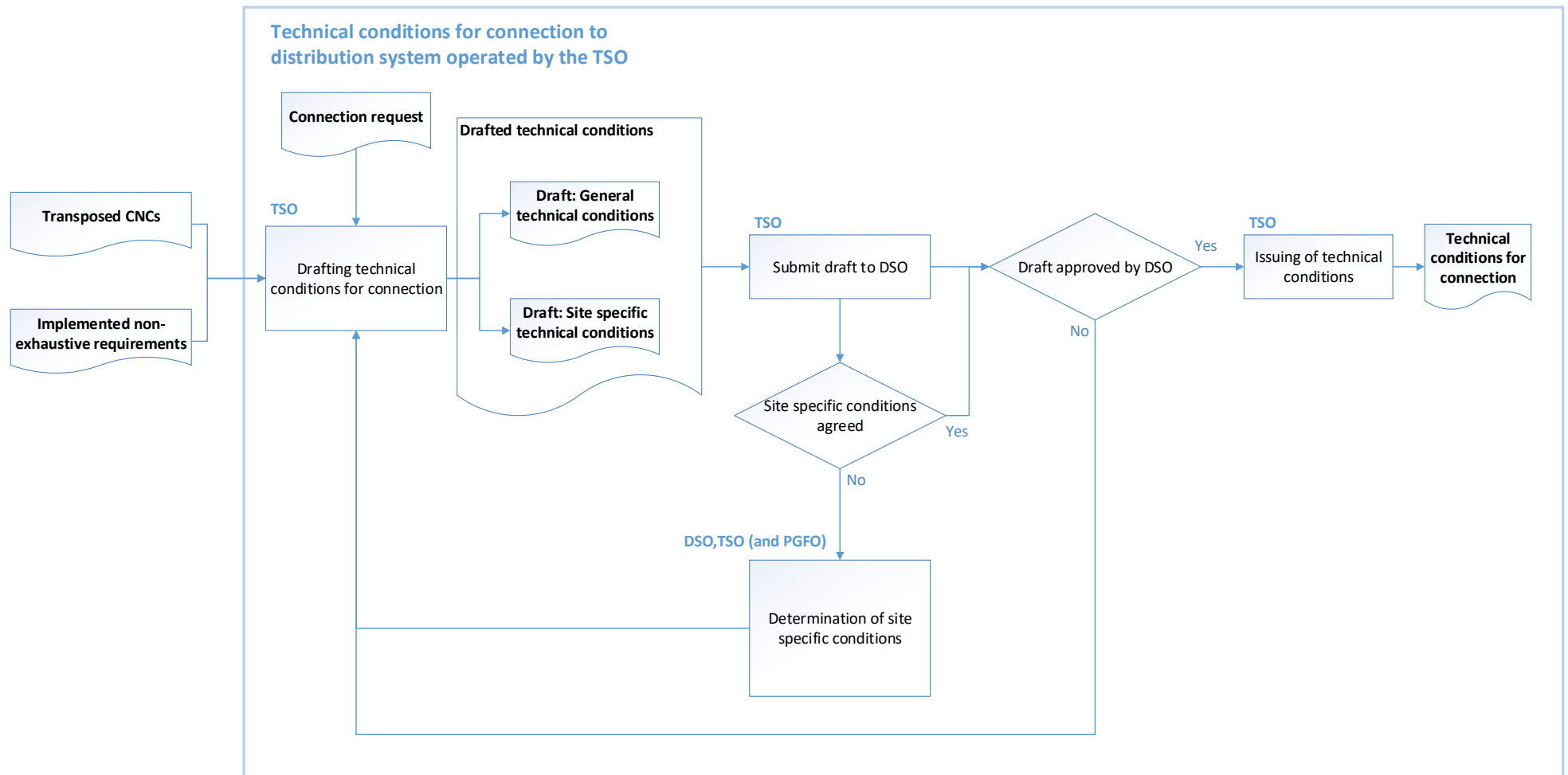

Figure 75 - Issuing technical conditions for connection when non - exhaustive parameters are defined in Grid Code

2.4. Derogation process

Derogation process is defined as exhaustive in the CNC and thus it is independent of the process of implementation of non-exhaustive parameters.

Two reasons for initiating the derogation process when TSO/DSO collaboration is required have been identified. First reason is when PGFO seeking connection to distribution system requests derogation for condition resulting from non-exhaustive requirement defined by TSO. Second reason is when DSO requests derogation for conditions resulting from non-exhaustive requirements defined by TSO in DCC, in case when the condition cannot be met due to the lack of DSO infrastructure.

According to [47] Article 62, Paragraph 4 *“The relevant system operator shall, in coordination with the relevant TSO and any affected adjacent DSO or DSOs, assess the request for a derogation and the provided cost-benefit analysis, taking into account the criteria determined by the regulatory authority pursuant to Article 61. If a request for a derogation concerns a type C or D power-generating module connected to a distribution system, including a closed distribution system, the relevant system operator’s assessment must be accompanied by an assessment of the request for a derogation by the relevant TSO.”*

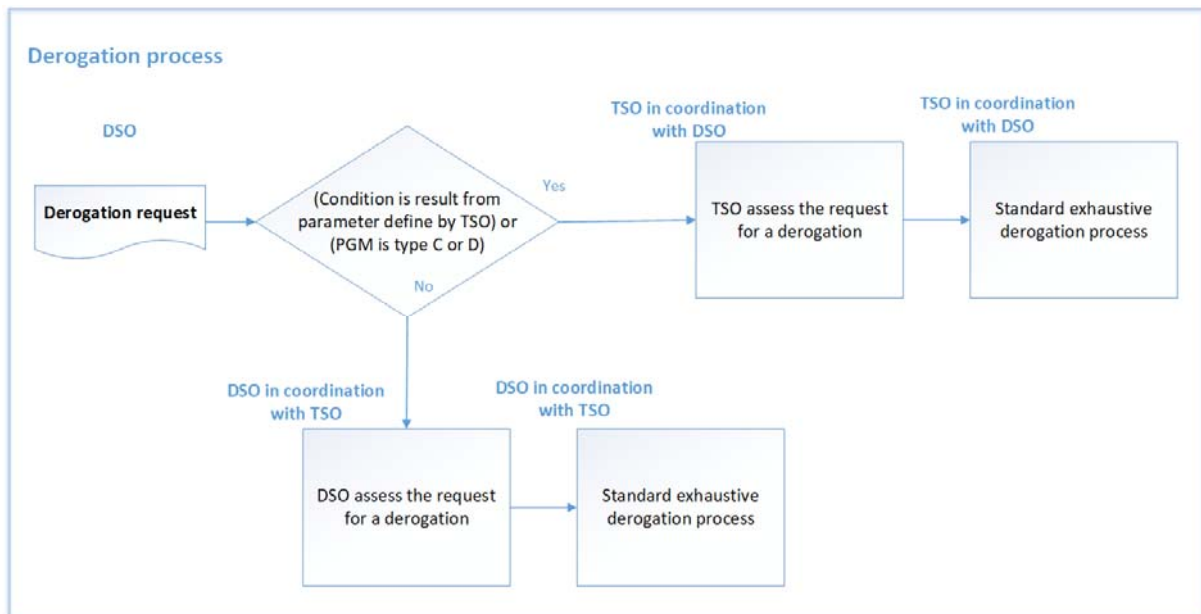

Figure 76 - Derogation process

2.5. Compliance process

Compliance process is defined as exhaustive in the CNC and thus it is independent of the process of implementation of non-exhaustive requirements.

According to [47] Article 40 Paragraph 4 *“The power-generating facility owner shall notify the relevant system operator of the planned test schedules and procedures to be followed for verifying the compliance of a power-generating module with the requirements of this Regulation, in due time and prior to their launch. The relevant system operator shall approve in advance the planned test schedules and procedures. Such approval by the relevant system operator shall be provided in a timely manner and shall not be unreasonably withheld.”*

With regards to compliance testing plan and procedure for PGMs connected to the distribution network, PFGO prepares Compliance test protocol. The protocol has to be approved by the DSO. If conditions that should be verified through compliance testing result from general requirements defined by TSO, or site-specific requirements defined by the TSO or by the DSO in cooperation with the TSO, then Compliance test protocol has to be approved by the TSO, also.

According to [47] Article 41 Paragraph 2 “The relevant system operator shall have the right to request that the power-generating facility owner carry out compliance tests and simulations according to a repeat plan or general scheme or after any failure, modification or replacement of any equipment that may have an impact on the power-generating module's compliance with the requirements of this Regulation”.

When compliance test is performed, for PGMs connected to the distribution network, PFGO with DSO performs test. If condition that should be verified through the test results from general requirements defined by TSO, or site-specific requirements defined by the TSO or by the DSO in cooperation with the TSO, TSO shall participate in the test. In any case, TSO should at least be notified that the test is planned and to be informed about compliance test procedure.

According to [47] Article 42 Paragraph 1 “Testing of the performance of individual power-generating modules within a power-generating facility shall aim at demonstrating that the requirements of this Regulation have been complied with”.

After compliance testing is finished, for PGMs connected to distribution network, DSO confirms whether all conditions are met. A necessary prerequisite is TSO’s positive opinion on compliance with general requirements defined by TSO, or site-specific requirements defined by the TSO or by the DSO in cooperation with the TSO.

Processes of Compliance testing, when collaboration TSO/DSO is necessary, is shown on the figure below.

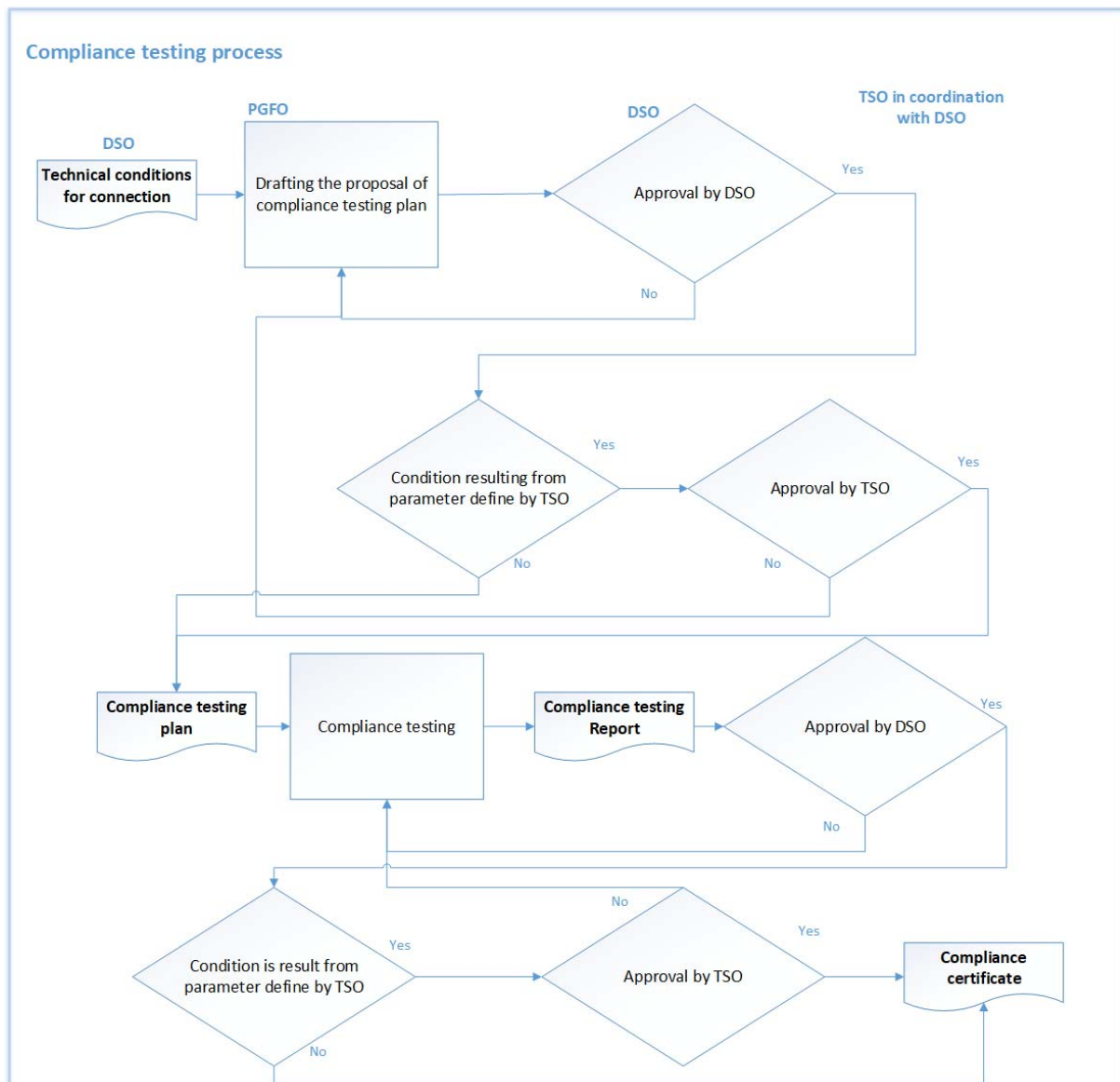

Figure 77 - Compliance testing

2.6. Process of changing and administration Grid Codes

With regard to TSO/DSO collaboration only the process of changing DSO Grid Code is considered, when it is required to change the parameter that is defined by TSO. The process of changing and administering grid code is similar to the process of derogation. When a system operator requires a condition derogation for all users, the derogation process and the grid code modification process are identical processes.

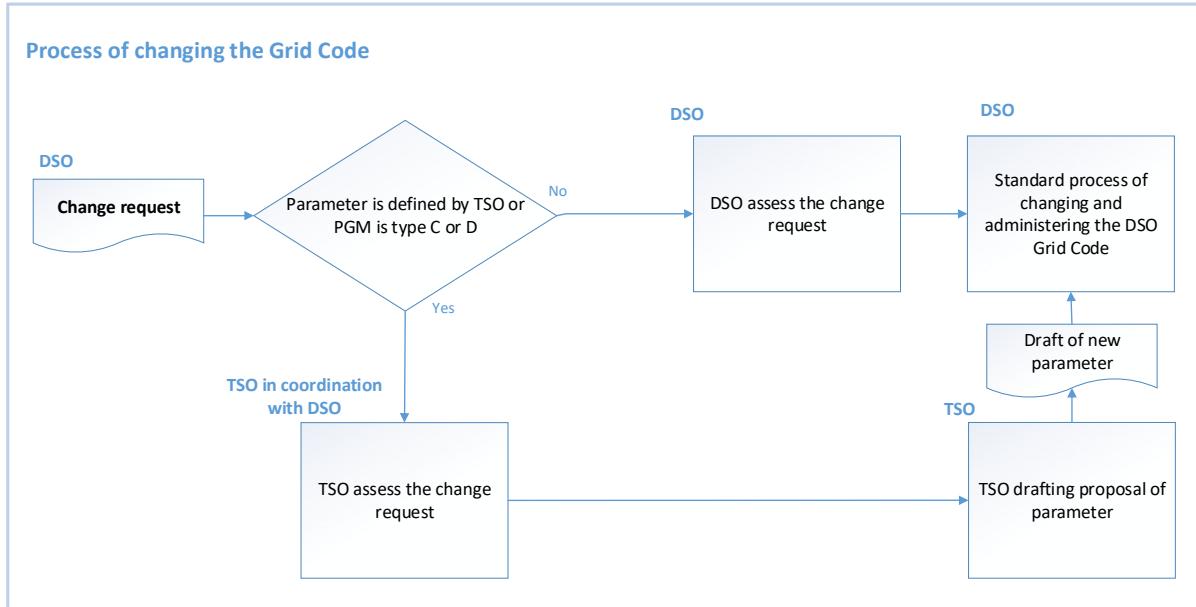

Figure 78 -Process of changing and administration Grid Codes

3. Mutual TSO and DSO connection issues and business processes within RfG

3.1. Frequency Issues

Non – exhaustive parameters that refer to frequency are very important to system stability and because of that these parameters are the most significant for TSO. TSO shall set all parameters refer to frequency, or approve parameters that define DSO.

All frequency non – exhaustive parameters can be applied to PGMs on distribution network. In such case DSO shall involve TSO in processes of issuing technical conditions for connection and compliance testing.

When DSO infrastructure is missing to fulfil this type of requirement, requirement define by TSO that is required for PGMs on distribution network, in that case TSO shall derogate that requirements to all PGMs on distribution network.

Non-exhaustive Requirement	Frequency Ranges – Potential wider frequency ranges Potential longer minimum times Specific requirements for frequency and voltage deviations
Articles 13(1)(a)(i), 13(1)(a)(ii):	“1. Type A power-generating modules shall fulfil the following requirements relating to frequency stability: (a)With regard to frequency ranges: (ii) the relevant system operator, in coordination with the relevant TSO, and the power-generating facility owner may agree on wider frequency ranges, longer minimum times for operation or specific requirements for combined frequency and voltage deviations to ensure the best use of the technical capabilities of a power-generating module, if it is required to preserve or to restore system security;”
Applicability:	Type A, B, C and D PGMs
Non-mandatory	
Site specific	

When this parameter is necessary for PGMs on distribution network, the initiative to set this parameter needs to be started by the TSO. DSO is process owner with strong coordination with TSO and PFGO. The parameter can only be set if all three parties agree.

Non-exhaustive Requirement	Rate-of-Change-of-Frequency – Specify RoCoF of the loss of main protection
Articles 13(1)(b)	<p>1. <i>Type A power-generating modules shall fulfil the following requirements relating to frequency stability:</i></p> <p><i>(b)With regard to the rate of change of frequency withstand capability, a power-generating module shall be capable of staying connected to the network and operate at rates of change of frequency up to a value specified by the relevant TSO, unless disconnection was triggered by rate-of-change- of-frequency-type loss of mains protection. The relevant system operator, in coordination with the relevant TSO, shall specify this rate-of-change-of-frequency-type loss of mains protection.</i></p>
Applicability:	Type A, B, C and D PGMs
Mandatory	
Site specific	
This parameter shall be defined by TSO, and if PGMs are on distribution network DSO can add additional conditions for disconnection.	
Non-exhaustive Requirement	List of the necessary data which will be sent in real time Definition of additional signals
Articles 15(2)(g)	<p><i>(g)with regard to real-time monitoring of FSM:</i></p> <p><i>(i)to monitor the operation of active power frequency response, the communication interface shall be equipped to transfer in real time and in a secured manner from the power-generating facility to the network control centre of the relevant system operator or the relevant TSO, at the request of the relevant system operator or the relevant TSO, at least the following signals:</i></p> <ul style="list-style-type: none"> <i>– status signal of FSM (on/off),</i> <i>– scheduled active power output,</i> <i>– actual value of the active power output,</i> <i>– actual parameter settings for active power frequency response,</i> <i>– droop and deadband;</i> <p><i>(ii)the relevant system operator and the relevant TSO shall specify additional signals to be provided by the power-generating facility by monitoring and recording devices in order to verify the performance of the active power frequency response provision of participating power-generating modules.</i></p>
Applicability:	Type C and D
Mandatory	
Site Specific	
This list of data shall be defined by TSO, and if PGMs are on distribution network DSO can add additional data on the list. To meet this condition, a specific infrastructure on the distribution network is required.	

	Taking into consideration the specific characteristics of the prime mover technology:
Non-exhaustive Requirement	Minimum limit of change of active power output in down direction Maximum limit of change of active power output in down direction Minimum limit of change of active power output in up direction Maximum limit of change of active power output in up direction
Articles 15(6)(e)	<i>(e)the relevant system operator shall specify, in coordination with the relevant TSO, minimum and maximum limits on rates of change of active power output (ramping limits) in both an up and down direction of change of active power output for a power-generating module, taking into consideration the specific characteristics of prime mover technology;</i>
Applicability:	Type C and D
Mandatory	
General	

This parameter shall be defined by TSO, and if PGMs are on distribution network DSO can define a condition that is stricter than the one defined by the TSO.

3.2. Voltage Issues

3.2.1. Automatic Disconnection due to Voltage Level

Non-exhaustive Requirement	Settings for automatic disconnection of PGMs
Article 15.3:	<i>“3. With regard to voltage stability, type C power-generating modules shall be capable of automatic disconnection when voltage at the connection point reaches levels specified by the relevant system operator in coordination with the relevant TSO. The terms and settings for actual automatic disconnection of power-generating modules shall be specified by the relevant system operator in coordination with the relevant TSO.”</i>
Applicability:	Type C, D PGMs
Mandatory	
Site specific	

For this requirement and type C PGMs, DSO in coordination with TSO defines voltage level at the connection point at which PGM shall be capable of automatic disconnection. Also, the terms and settings of automatic disconnection of PGMs are specified by the DSO in coordination with the TSO. Having in mind that this is site specific requirement, this can be done during the connection process, in a way that the DSO shall submit proposal for connection conditions to TSO for coordination before the technical conditions are issued to the PGFO, but in due time for plant design.

Non-exhaustive Requirement	Definition of threshold for automatic disconnection
Article 16.2(c):	<i>“(c) without prejudice to point (a), the relevant system operator in coordination with the relevant TSO shall have the right to specify voltages at the connection point at which a power-generating module is capable of automatic disconnection. The terms and settings for automatic disconnection shall be agreed between the relevant system operator and the power-generating facility owner.”</i>
Applicability:	Type C, D PGMs
Non-mandatory	
Site specific	

As in the case of previous requirement, for type C PGMs, DSO in coordination with TSO defines voltage level at the connection point at which PGM shall be capable of automatic disconnection. Also, the terms and settings of automatic disconnection of PGMs are specified by the DSO in coordination with the TSO. After the DSO and TSO have coordinated this requirement it should be further agreed with the PGFO. Having in mind that this is site specific requirement, this can be done during the connection process, in a way that the RSO submits proposal on technical conditions to TSO for coordination before the proposal for technical conditions are submitted to the PGFO.

3.2.2. Reactive Power Capability

Non-exhaustive Requirement	<i>Reactive power capability at maximum capacity i.e. U-Q/Pmax profile</i>
18.2(b):	<p><i>“with regard to reactive power capability at maximum capacity:</i></p> <p><i>(i) the relevant system operator in coordination with the relevant TSO shall specify the reactive power provision capability requirements in the context of varying voltage. For that purpose the relevant system operator shall specify a U-Q/Pmax-profile within the boundaries of which the synchronous power-generating module shall be capable of providing reactive power at its maximum capacity. The specified U-Q/Pmax profile may take any shape, having regard to the potential costs of delivering the capability to provide reactive power production at high voltages and reactive power consumption at low voltages;</i></p> <p><i>(ii) the U-Q/Pmax-profile shall be specified by the relevant system operator in coordination with the relevant TSO, in conformity with the following principles:</i></p> <ul style="list-style-type: none"> <i>• the U-Q/Pmax-profile shall not exceed the U-Q/Pmax-profile envelope, represented by the inner envelope in Figure 7,</i> <i>• the dimensions of the U-Q/Pmax-profile envelope (Q/Pmax range and voltage range) shall be within the range specified for each synchronous area in Table 8, and</i> <i>• the position of the U-Q/Pmax-profile envelope shall be within the limits of the fixed outer envelope in Figure 7;”</i> <p><i>(iii) the reactive power provision capability requirement applies at the connection point. For profile shapes other than rectangular, the voltage range represents the highest and lowest values. The full reactive power range is therefore not expected to be available across the range of steady-state voltages;</i></p> <p><i>(iv) the synchronous power-generating module shall be capable of moving to any operating point within its U-Q/Pmax profile in appropriate timescales to target values requested by the relevant system operator;</i></p>
Applicability:	Type C and D SPGMs
Mandatory	
General	

Non-exhaustive Requirement

Reactive power capability at maximum capacity i.e. U-Q/Pmax profile

Articles 21.3(b):

“with regard to reactive power capability at maximum capacity:

(i) the relevant system operator in coordination with the relevant TSO shall specify the reactive power provision capability requirements in the context of varying voltage. To that end, it shall specify a U-Q/Pmax-profile that may take any shape within the boundaries of which the power park module shall be capable of providing reactive power at its maximum capacity;

(ii) the U-Q/Pmax-profile shall be specified by each relevant system operator in coordination with the relevant TSO in conformity with the following principles:

- the U-Q/Pmax-profile shall not exceed the U-Q/Pmax-profile envelope, represented by the inner envelope in Figure 8,*
 - the dimensions of the U-Q/Pmax-profile envelope (Q/Pmax range and voltage range) shall be within the values specified for each synchronous area in Table 9,*
 - the position of the U-Q/Pmax-profile envelope shall be within the limits of the fixed outer envelope set out in Figure 8, and*
 - the specified U-Q/Pmax profile may take any shape, having regard to the potential costs of delivering the capability to provide reactive power production at high voltages and reactive power consumption at low voltages;”*
-

Applicability: Type C and D PPMs

Mandatory

General

In the case of reactive power capability requirement at maximum capacity for type C PGMs, DSO defines the requirement in coordination with TSO. Having in mind that this is general requirement, it means that DSO and TSO should cooperate for the definition of this non-exhaustive requirement during the implementation of the non-exhaustive requirement at national level.

3.2.3. Reactive Power Capability below maximum power

Non-exhaustive Requirement	<p>Reactive Power Capability below maximum power</p> <p>Appropriate timescale to reach any operating point within U- Q/Pmax-profile</p>
Articles 21.3(c):	<p><i>“(c) with regard to reactive power capability below maximum capacity:</i></p> <p><i>(ii) the P-Q/Pmax-profile shall be specified by each relevant system operator in coordination with the relevant TSO, in conformity with the following principles:</i></p> <ul style="list-style-type: none"> • the P-Q/Pmax-profile shall not exceed the P-Q/Pmax-profile envelope, represented by the inner envelope in Figure 9, • the Q/Pmax range of the P-Q/Pmax-profile envelope is specified for each synchronous area in Table 9, • the active power range of the P-Q/Pmax-profile envelope at zero reactive power shall be 1 pu, • the P-Q/Pmax-profile can be of any shape and shall include conditions for reactive power capability at zero active power, and • the position of the P-Q/Pmax-profile envelope shall be within the limits of the fixed outer envelope set out in Figure 9; <p><i>(iii) when operating at an active power output below maximum capacity ($P < P_{max}$), the power park module shall be capable of providing reactive power at any operating point inside its P-Q/Pmax-profile, if all units of that power park module which generate power are technically available that is to say they are not out of service due to maintenance or failure, otherwise there may be less reactive power capability, taking into consideration the technical availabilities;</i></p> <p><i>The diagram represents boundaries of a P-Q/Pmax-profile at the connection point by the active power, expressed by the ratio of its actual value and the maximum capacity pu, against the ratio of the reactive power (Q) and the maximum capacity (Pmax). The position, size and shape of the inner envelope are indicative.</i></p> <p><i>(iv) the power park module shall be capable of moving to any operating point within its P-Q/Pmax profile in appropriate timescales to target values requested by the relevant system operator;</i></p>
Applicability:	Type C and D PPMs
Mandatory	
General	

In the case of reactive power capability below maximum capacity requirement for type C PPMs, DSO defines the requirement in coordination with TSO. Having in mind that this is general requirement, it means that DSO and TSO should cooperate during the definition of this non-exhaustive requirement during the implementation of the non-exhaustive requirement at national level.

3.2.4. Voltage/Reactive Power Control

3.2.4.1. Reactive Power Control

Non-exhaustive Requirement	Voltage control mode: t1: time within which 90% of the change in reactive power is reached t2: time within which 100% of the change in reactive power is reached
	Power factor control mode: Target power factor Time period to reach the set point Tolerance

Article 21.3(d): *“3.Type C power park modules shall fulfil the following additional requirements in relation to voltage stability:*

...

(d) with regard to reactive power control modes:

(i) the power park module shall be capable of providing reactive power automatically by either voltage control mode, reactive power control mode or power factor control mode;

(ii) for the purposes of voltage control mode, the power park module shall be capable of contributing to voltage control at the connection point by provision of reactive power exchange with the network with a setpoint voltage covering 0,95 to 1,05 pu in steps no greater than 0,01 pu, with a slope having a range of at least 2 to 7 % in steps no greater than 0,5 %. The reactive power output shall be zero when the grid voltage value at the connection point equals the voltage setpoint;

(iii) the setpoint may be operated with or without a deadband selectable in a range from zero to ± 5 % of reference 1 pu network voltage in steps no greater than 0,5 %;

(iv) following a step change in voltage, the power park module shall be capable of achieving 90 % of the change in reactive power output within a time t1 to be specified by the relevant system operator in the range of 1 to 5 seconds, and must settle at the value specified by the slope within a time t2 to be specified by the relevant system operator in the range of 5 to 60 seconds, with a steady-state reactive tolerance no greater than 5 % of the maximum reactive power. The relevant system operator shall specify the time specifications;

(v) for the purpose of reactive power control mode, the power park module shall be capable of setting the reactive power setpoint anywhere in the reactive power range, specified by point (a) of Article 20(2) and by points (a) and (b) of Article 21(3), with setting steps no greater than 5 MVAR or 5 % (whichever is smaller) of full reactive power, controlling the reactive power at the connection point to an accuracy within plus or minus 5 MVAR or plus or minus 5 % (whichever is smaller) of the full reactive power;

Article 21.3(d): *(vi) for the purpose of power factor control mode, the power park module shall be capable of controlling the power factor at the connection point within the required reactive power range, specified by the relevant system operator according to point (a) of Article 20(2) or specified by points (a) and (b) of Article 21(3), with a target power factor in steps no greater than 0,01. The relevant system operator shall specify the target power factor value, its tolerance and the period of time to achieve the target power factor following a sudden change of active power output. The tolerance of the target power factor shall be expressed through the tolerance of its corresponding reactive power. This reactive power tolerance shall be expressed by either an absolute value or by a percentage of the maximum reactive power of the power park module;*

(vii) the relevant system operator, in coordination with the relevant TSO and with the power park module owner, shall specify which of the above three reactive power control mode options and associated setpoints is to apply, and what further equipment is needed to make the adjustment of the relevant setpoint operable remotely,,

Applicability: Type C and D PPMs

Mandatory

In the case of type C PPMs specification which of the three reactive power operation modes i.e. voltage control, reactive power control or power factor mode is agreed between the DSO and PGFO, in coordination with the TSO. Having in mind that this is site specific requirement, this can be done during the connection process, in a way that the DSO shall submit proposal for connection conditions to TSO for coordination before the technical conditions are submitted to the PGFO, for agreement.

3.3. System Restoration Issues

Requirements refer to System restoration have to be defined only for PGMs on transmission network, the PGMs for which the TSO is responsible. Only requirements refer to “Operation following Tripping to Houseload” can be defined and apply to PGMs on distribution network.

Non-exhaustive Requirement Provision of quick re-synchronisation capability

Articles 15(5)(c)(i) *(c)with regard to quick re-synchronisation capability:
(i)in case of disconnection of the power-generating module from the network, the power-generating module shall be capable of quick re-synchronisation in line with the protection strategy agreed between the relevant system operator in coordination with the relevant TSO and the power generating facility;*

Applicability: Type C and D

Non - Mandatory

General

Non-exhaustive Requirement Minimum operation time within which the PGM is capable of operating after tripping

Articles 15(5)(c)(iii) *(iii) power-generating modules shall be capable of continuing operation following tripping to houseload, irrespective of any auxiliary connection to the external network. The minimum operation time shall be specified by the relevant system operator in coordination with the relevant TSO, taking into consideration the specific characteristics of prime mover technology.*

Applicability: Type C and D

Mandatory

General

Collaboration is considered when parameters are defined for PGMs on distribution network. DSO is process owner with strong coordination with TSO and PFGO. The parameter can only be set if all three parties agree.

3.4. Instrumentation, Simulation Models and Protections Issues

3.4.1. Control and Protection Scheme and Settings

Non-exhaustive Requirement Control schemes
Settings of the control devices

Articles 14.5(a): *“(a) with regard to control schemes and settings:
(i) the schemes and settings of the different control devices of the power-generating module that are necessary for transmission system stability and for taking emergency action shall be coordinated and agreed between the relevant TSO, the relevant system operator and the power-generating facility owner;
(ii) any changes to the schemes and settings, mentioned in point (i), of the different control devices of the power generating module shall be coordinated and agreed between the relevant TSO, the relevant system operator and the power-generating facility owner, in particular if they apply in the circumstances referred to in point (i) of paragraph 5(a);”*

Applicability: Type B, C and D PGMs

Mandatory

Site specific

For this requirement, and type B, C PGMs, control schemes are agreed between DSO and PGFO in coordination with TSO. Having in mind that this is site specific requirement, this can be done during the connection process, in a way that the DSO shall submit proposal for control protection schemes and settings to TSO for coordination before the technical conditions are issued to the PGFO, but in due time for plant design.

3.4.2. Instrumentation

Non-exhaustive Requirement Settings of the fault recording equipment
Triggering criteria of the fault recording equipment
Sampling rates of the fault recording equipment
Specifications of the oscillation trigger
Protocols for recorded data

Articles 15(6)(b)(i-ii) *(b) with regard to instrumentation:
(i) power-generating facilities shall be equipped with a facility to provide fault recording and monitoring of dynamic system behaviour. This facility shall record the following parameters:*

- voltage,
- active power,
- reactive power, and
- frequency.

The relevant system operator shall have the right to specify quality of supply parameters to be complied with on condition that reasonable prior notice is given;

(ii) the settings of the fault recording equipment, including triggering criteria and the sampling rates shall be agreed between the power-generating facility owner and the relevant system operator in coordination with the relevant TSO;

Articles 15(6)(b)(iii-iv)	<p><i>(iii) the dynamic system behaviour monitoring shall include an oscillation trigger specified by the relevant system operator in coordination with the relevant TSO, with the purpose of detecting poorly damped power oscillations;</i></p> <p><i>(iv) the facilities for quality of supply and dynamic system behaviour monitoring shall include arrangements for the power-generating facility owner, and the relevant system operator and the relevant TSO to access the information. The communications protocols for recorded data shall be agreed between the power-generating facility owner, the relevant system operator and the relevant TSO;</i></p>
----------------------------------	-----------------------------------------------------------------------------------------------------------------------------------------------------------------------------------------------------------------------------------------------------------------------------------------------------------------------------------------------------------------------------------------------------------------------------------------------------------------------------------------------------------------------------------------------------------------------------------------------------------------------------------------------------------------------

Applicability: Type C and D PGMs

Non-mandatory/mandatory

Site specific

For this requirement, and type C PGMs, settings of fault recording equipment are agreed between DSO and PGFO in coordination with TSO. Having in mind that this is site specific requirement, this can be done during the connection process, in a way that the DSO shall submit proposal for fault recorder settings to the TSO for coordination before the technical conditions are issued to the PGFO, but in due time for plant design.

3.4.3. Simulation models

Non-exhaustive Requirement	<p>Provision of simulation models</p> <p>Specifications of the simulation models</p> <p>Recordings of PGM performance</p>
Article 15.6(c):	<p><i>“c) with regard to the simulation models:</i></p> <p><i>(v) at the request of the relevant system operator or the relevant TSO, the power-generating facility owner shall provide simulation models which properly reflect the behaviour of the power-generating module in both steady-state and dynamic simulations (50 Hz component) or in electromagnetic transient simulations.</i></p> <p><i>The power-generating facility owner shall ensure that the models provided have been verified against the results of compliance tests referred to in Chapters 2, 3 and 4 of Title IV, and shall notify the results of the verification to the relevant system operator or relevant TSO. Member States may require that such verification be carried out by an authorised certifier;</i></p> <p><i>(vi) the models provided by the power-generating facility owner shall contain the following sub-models, depending on the existence of the individual components:</i></p> <ul style="list-style-type: none"> • alternator and prime mover, • speed and power control, • voltage control, including, if applicable, power system stabiliser ('PSS') function and excitation control system, • power-generating module protection models, as agreed between the relevant system operator and the power-generating facility owner, and <p><i>(vii) converter models for power park modules:</i></p>

Article 15.6(c): (iii) the request by the relevant system operator referred to in point (i) shall be coordinated with the relevant TSO. It shall include:

- - the format in which models are to be provided,
- - the provision of documentation on a model's structure and block diagrams,
- - an estimate of the minimum and maximum short circuit capacity at the connection point, expressed in MVA, as an equivalent of the network;

(iv) the power-generating facility owner shall provide recordings of the power-generating module's performance to the relevant system operator or relevant TSO if requested. The relevant system operator or relevant TSO may make such a request, in order to compare the response of the models with those recordings;”

Applicability: Type C and D PGMs

Non-mandatory

This is non-mandatory but general requirement. Having that in mind DSO and TSO should cooperate with each other for the definition of this non-exhaustive requirement during the implementation of the non-exhaustive requirement at national level. As already proposed in the Methodology detailed methodology for the simulation modules creation, definition and validation should be defined in details in order to avoid ambiguities during the implementation of the requirement. Also coordination between TSO and DSO is important to have interchangeable models.

3.4.4. Information exchange

Non-exhaustive Requirement	Content of information exchange Precise list of data to be facilitated Precise time of data to be facilitated
-----------------------------------	---------------------------------------------------------------------------------------------------------------------

Article 14(5)(d)(i)(ii) (d) with regard to information exchange:
(i) power-generating facilities shall be capable of exchanging information with the relevant system operator or the relevant TSO in real time or periodically with time stamping, as specified by the relevant system operator or the relevant TSO;
(ii) the relevant system operator, in coordination with the relevant TSO, shall specify the content of information exchanges including a precise list of data to be provided by the power-generating facility.

Applicability: Type B,C and D PGMs

Mandatory

Site specific

Regarding precise list of data that should be defined DSO and TSO should cooperate in the definition of the data list, during the implementation of the non-exhaustive requirements at national level. They should also agree on communication principle and protocols used for information exchange. As it is already recommended in the Methodology it is should be facilitated that the PGMs exchange information with only one system operator. This means that PGMs connected to the distribution network should exchange real time data with the DSO which will further forward needed information to the TSO. This should help that transfer of confidential data through the unsecured networks is avoided or at least minimized.

3.4.5. Disconnection from grid caused by angular instability or loss of control

Non-exhaustive Requirement Criteria to detect loss of angular stability or loss of control

Article 15.6(a): *“(a) with regard to loss of angular stability or loss of control, a power-generating module shall be capable of disconnecting automatically from the network in order to help preserve system security or to prevent damage to the power-generating module. The power-generating facility owner and the relevant system operator in coordination with the relevant TSO shall agree on the criteria for detecting loss of angular stability or loss of control;”*

Applicability: Type C and D PGMs

Mandatory

Site specific

For this requirement and type C PGMs, DSO in coordination with TSO defines the criteria for detecting loss of angular stability or loss of control that shall be agreed with PGFO. Having in mind that this is site specific requirement, this can be done during the connection process, in a way that the DSO shall submit proposal for connection conditions to TSO for coordination before the technical conditions are submitted to the PGFO, for further agreement.

4. Mutual TSO and DSO connection issues and business processes within DCC

4.1. Frequency Issues

4.1.1. Frequency Ranges

Non-exhaustive Requirement	<ul style="list-style-type: none"> • Potential wider frequency ranges • Potential longer minimum times
Article 12(2):	<i>“(2) The transmission-connected demand facility owner or the DSO may agree with the relevant TSO on wider frequency ranges or longer minimum times for operation. If wider frequency ranges or longer minimum times for operation are technically feasible, the consent of the transmission-connected demand facility owner or DSO shall not be unreasonably withheld.”</i>
Applicability:	TC DF and TC DS
Non-mandatory	
Site specific	

A need for the agreement between the relevant TSO and the transmission-connected demand facility owner or the DSO imposed by the Article 12(2) of the DCC depends on whether the non-mandatory requirements within this article are implemented at national level. The main motivation and reasons for the implementation these non-mandatory requirements are given in the Chapters 2.2.1. and 3.1.1. of the Methodology. If these non-mandatory requirements are implemented at national level this means that the relevant TSO expects an occurrence of a wider frequency ranges within its transmission system or it expects that standard time limited frequency ranges last longer than defined by the DCC. Therefore, if this is the case, the relevant TSO has to agree on wider frequency ranges or longer minimum times for operation with the transmission-connected demand facility owner or DSO. Having in mind that overall security of the system and potential avoiding of the blackout depend on this agreement, as stated in the Article 12(2), *If wider frequency ranges or longer minimum times for operation are technically feasible, the consent of the transmission-connected demand facility owner or DSO shall not be unreasonably withheld.* However, it should be pointed out that if the relevant TSO demands from the transmission-connected demand facility owner or the DSO to agree on the wider frequency ranges or the longer minimum times, this demands should be justified by means of the simulation. The simulation should clearly show that wider frequency ranges are highly possible or that there is a need for the longer minimum times for operation. On the other hand, if the transmission-connected demand facility owner or the DSO deem that the wider frequency ranges or longer minimum times are not technically feasible, this should be justified through the join analysis between the relevant TSO and the TC DF owner or the DSO. The above described procedure should be applied during connection phase but in due time for facility design.

The relevant TSO and the TC DF owner or the DSO may agree on participating particular facility in the black start operation plan. If simulation of the black start procedure shows that during the black start particular facility can be exposed to the frequency ranges or minimum operation times wider than ones already defined, the agreement on black start operation plan should also contain the agreement on the wider frequency ranges or the longer minimum times.

4.2. Voltage Issues

4.2.1. Automatic Disconnection Due to Voltage Level

Non-exhaustive Requirements	<ul style="list-style-type: none"> • Voltage criteria parameters at the connection point for automatic disconnection • Technical parameters at the connection point for automatic disconnection
Article 13(6):	<i>“6. If required by the relevant TSO, a transmission-connected demand facility, a transmission-connected distribution facility, or a transmission-connected distribution system shall be capable of automatic disconnection at specified voltages. The terms and settings for automatic disconnection shall be agreed between the relevant TSO and the transmission-connected demand facility owner or the DSO.”</i>
Applicability:	TC DF and TC DS
Non-mandatory	
Site specific	

As already described in the Chapter 3.2.2. of the Methodology the main motivation for the relevant TSO to implement this non-mandatory requirement would be the existence of the TC DS or the TC DF to be connected via radial power line. Therefore, if this requirement is implemented at national level this means that relevant TSO expects to have request for the connection the TC DS or the TC DF via radial power line. In case of such connection, the relevant TSO and the TC DSO or the TC DF owner should conduct joint analysis in order to determine whether and under which condition may come to the voltage instability. The main outcomes of that analysis should be the terms and settings for automatic disconnection. This analysis should be done during connection phase but in due time for a facility design.

4.2.2. Reactive power capability for TC DF and TC DS

Non-exhaustive Requirements	<ul style="list-style-type: none"> • Definition of the scope of the analysis to find the optimal solution for reactive power • Method to carry out active control the exchange of reactive power at the connection point
Article 15(1)(c), Article 15(3):	<p><i>(c) the relevant TSO and the transmission-connected distribution system operator shall agree on the scope of the analysis, which shall address the possible solutions, and determine the optimal solution for reactive power exchange between their systems, taking adequately into consideration the specific system characteristics, variable structure of power exchange, bidirectional flows and the reactive power capabilities in the distribution system;</i></p> <p><i>“3. Without prejudice to point (b) of paragraph 1, the relevant TSO may require the transmission-connected distribution system to actively control the exchange of reactive power at the connection point for the benefit of the entire system. The relevant TSO and the transmission-connected distribution system operator shall agree on a method to carry out this control, to ensure the justified level of security of supply for both parties. The justification shall include a roadmap in which the steps and the timeline for fulfilling the requirement are specified.”</i></p>
Applicability:	TC DS
Mandatory	
Site specific	

According to the Article 15(1)(b) the relevant TSO should specify the actual reactive power range at TSO/DSO interface. However, the Article 15(1)(c) leaves room for optimizing specified ranges in order to achieve global optimum regarding reactive power exchange at TSO/DSO interface. The optimization of the specified ranges should be done through a joint analysis between the relevant TSO and the DSO. As starting point TSO and DSO should analyse reactive power needs of system under its control, and determine existing reactive power resources and its real capabilities. The analysis should be conducted for critical operating regimes, for existing and planned power system state, taking into consideration operational limitations. Next step would be to update existing TSO/DSO models and perform load flow analysis to determine is it possible to optimize utilization of existing resources (existing compensation devices/facilities, OLTC, reactive power loading of existing generators etc.) in order to achieve power factor at TSO/DSO interface at or above currently nationally implemented threshold. If this is not possible there are two additional analyses that should be performed. The first one would be determination of new projects and associated investment costs that would lead to existing prescribed value of power factor at TSO/DSO interface. The second one would be sensitivity analysis aimed towards lowering the value of required power factor at TS/DS interface and assessment of associated costs (both investment and variable costs from additional transmission/distribution active power losses). Considering results of the first and second analysis optimal solution can be found regarding required power factor at TS/DS interface that will include list of projects needed in order to achieve efficient reactive power management. Beside these analysis, analysis regarding dynamical reactive power reserve should be performed. If determined solution leads to generating modules that are operated on the very limit of underexcitation or overexcitation, this can have negative impact on dynamical voltage stability, because units operated at the very edge of their possibilities are not performing as P-U nodes but instead as P-Q nodes, which leads to fewer regulating nodes in the system.

As pointed out in [25] TSO and DSO can find added value in aggregation of connection points or grouping several connection points in a number of zones, and defining reactive power requirements for these zones. This should be done as a part of development of secondary voltage regulation scheme. A way to achieve efficient secondary voltage regulation system is by dividing system in zones that with nodes (both generating units and substation) that are electrically close. Determination of these zones will depend on system topology and characteristics.

These analyses could be performed periodically (as a part of system development planning), and in a way that can promote closer collaboration between TSO/DSO regarding reactive power management, which means that they should be part of the operation procedures agreed between TSO and DSO. Also, the recommendation of the Consultants is that these analyses to be performed at least during connection phase but in due time for facility design.

4.3. System Restoration Issues

4.3.1. Demand Disconnection for System Defence

Non-exhaustive Requirement

- Definition of the LVDD scheme

Article 19(2)(a):

“2. With regard to low voltage demand disconnection functional capabilities, the following requirements shall apply:

(a) the relevant TSO may specify, in coordination with the transmission-connected distribution system operators, low voltage demand disconnection functional capabilities for the transmission-connected distribution facilities;”

Applicability:

TC DS

Non-mandatory

General

As already described in the Chapter 3.3.2.2. of the Methodology, before the individual TSO decides to implement the LVDD scheme, a study aiming to assess if TSO’s control area is prone to voltage instability should be conducted. If the results of the study shows that LVDD schema should be implemented, then implementation of the LVDD schema should be done in coordination with the transmission-connected distribution system operators. The coordination is needed because the LVDD schema has to be fitted in the system defense plan which is usually already defined and agreed between TSO and DSO. In the other hand, having in mind that LVDD schema usually is realized as wide area protection (WAP) scheme, the strong coordination between TSO and DSO is needed in order to correct realize the LVDD schema. One party of the necessary coordination should be done through the connection agreement whereas certain degree of the coordination should be accomplished through the operation procedures.

Non-exhaustive Requirement

- Settings of the synchronisation devices (including frequency, voltage, phase angle range and deviation of voltage and frequency)

Article 19(4)(b):

*“(b) with regard to reconnection of a transmission-connected demand facility or a transmission-connected distribution system, the transmission-connected demand facility or the transmission-connected distribution system shall be capable of synchronisation for frequencies within the ranges set out in Article 12. **The relevant TSO and the transmission-connected demand facility owner or the transmission-connected distribution system operator shall agree on the settings of synchronisation devices prior to connection of the transmission-connected demand facility or the transmission-connected distribution system, including voltage, frequency, phase angle range and deviation of voltage and frequency;”***

Applicability:

TC DF and TC DS

Mandatory

Site specific

The agreement imposed by the Article 19(4)(b) should be achieved during the connection process and following procedure is proposed. After the TC DF or the TC DS submits connection requirement, TSO shall define any relevant site specific requirement related to the settings of synchronisation devices, as part of technical requirements for connection of transmission connected facility. After the completion of the design phase the TC DFO or the TC DSO should send applied settings of synchronisation devices to TSO for approval. The TC DF or the TC DS have to obtain TSO approval before the first powering of the facility, and to implement the settings of synchronisation devices agreed with TSO during this phase. The TC DF or the TC DS shall also conduct synchronisation devices testing according to the newly adopted and implemented settings and submit results to the TSO. Described steps should be part of the connecting procedure.

4.4. Instrumentation, Simulation Models and Protections Issues

4.4.1. Electrical Protection Scheme and Settings and Control Requirements

Non-exhaustive Requirement	<ul style="list-style-type: none"> • Electrical protection schemes • Electrical protection settings
Article 16(1):	<i>“1. The relevant TSO shall specify the devices and settings required to protect the transmission network in accordance with the characteristics of the transmission-connected demand facility or the transmission-connected distribution system. The relevant TSO and the transmission-connected demand facility owner or the transmission-connected distribution system operator shall agree on protection schemes and settings relevant for the transmission-connected demand facility or the transmission-connected distribution system.”</i>
Applicability:	TC DF and TC DS
Mandatory	
Site specific	
Non-exhaustive Requirement	<ul style="list-style-type: none"> • Control devices schemes • Control devices settings
Article 17(1):	<i>“1. The relevant TSO and the transmission-connected demand facility owner or the transmission-connected distribution system operator shall agree on the schemes and settings of the different control devices of the transmission-connected demand facility or the transmission-connected distribution system relevant for system security.”</i>
Applicability:	TC DF and TC DS
Mandatory	
Site specific	

The agreement imposed by the Articles 16(1) and 17(1) should be achieved during the connection process and following procedure is proposed. After the TC DF or the TC DS submits connection requirement, TSO shall define any relevant site specific requirement related to the control and protection scheme, as part of technical requirements for transmission connected facility. After the completion of the design phase the TC DF or the TC DS should, send protection function calculation/study to TSO for approval. The TC DF or the TC DS have to obtain TSO approval before the first powering of the facility, and to implement protection function settings agreed with TSO during this phase. The TC DF or the TC DS shall also conduct relay equipment testing according to the newly adopted and implemented settings and submit results to the TSO. Described steps should be part of the connecting procedure.

It is also recommended to the TSO to adopt documents regarding coordination of transmission connected facility protection functions and system protection functions. This document could be considered as technical standard applied by the TSO, and it could greatly help to the TC DFO or the TC DSO during the design phase and calculation of relevant protection function settings.

5. References

- [1] European Council. (2018). Commission Regulation (EU) 2016/631 of 14 April 2016 establishing a network code on requirements for grid connection of generators
- [2] European Council. (2018). Commission Regulation (EU) 2016/1388 of 17 August 2016 establishing a Network Code on Demand Connection
- [3] European Council. (2018). Commission Regulation (EU) 2016/1447 of 26 August 2016 establishing a network code on requirements for grid connection of high voltage direct current systems and direct current-connected power park modules
- [4] The Permanent High Level Group of Energy Community. (2018). DECISION No 2018/03/PHLG-EnC OF THE PERMANENT HIGH LEVEL GROUP OF THE ENERGY COMMUNITY of 12 January 2018 on incorporating Commission Regulation (EU) 2016/631 of 14 April 2016 establishing a Network Code on requirements for grid connection of generators in the Energy Community
- [5] The Permanent High Level Group of Energy Community. (2018). DECISION 2018/05/PHLG-EnC OF THE PERMANENT HIGH LEVEL GROUP OF THE ENERGY COMMUNITY of 12 January 2018 on incorporating Commission Regulation (EU) 2016/1388 of 17 August 2016 establishing a Network Code on Demand Connection in the Energy Community
- [6] The Permanent High Level Group of Energy Community. (2018). DECISION No 2018/04/PHLG-EnC OF THE PERMANENT HIGH LEVEL GROUP OF THE ENERGY COMMUNITY of 12 January 2018 on incorporating Commission Regulation (EU) 2016/1447 of 26 August 2016 establishing a network code on requirements for grid connection of high voltage direct current systems and direct current connected power park modules in the Energy Community
- [7] ENTSO-E. (2020). Parameters of Non-exhaustive Requirements, ENTSO-E, Guidance document for national implementation for network codes on grid connection
- [8] ENTSO-E. (2016). Parameters related to voltage issues, ENTSO-E guidance document for national implementation for network codes on grid connection
- [9] ENTSO-E. (2016). Reactive power control modes for PPM & HVDC, ENTSO-E guidance document for national implementation for network codes on grid connection
- [10] ENTSO-E. (2016). Reactive power requirement for PPMS & HVDC at low / zero power, ENTSO-E guidance document for national implementation for network codes on grid connection
- [11] ENTSO-E. (2016). Fault current contribution from PPMS & HVDC, ENTSO-E guidance document for national implementation for network codes on grid connection
- [12] ENTSO-E. (2016). Instrumentation, simulation models and protection, ENTSO-E guidance document for national implementation for network codes on grid connection
- [13] ENTSO-E. (2016). Selecting national MW boundaries, ENTSO-E guidance document for national implementation for network codes on grid connection
- [14] ENTSO-E. (2016). Demand Response - System Frequency Control, ENTSO-E guidance document for national implementation for network codes on grid connection
- [15] ENTSO-E. (2016). Reactive power management at T - D interface, ENTSO-E guidance document for national implementation for network codes on grid connection
- [16] ENTSO-E. (2016). Making non-mandatory requirements at European level mandatory at national level, ENTSO-E guidance document for national implementation for network codes on grid connection
- [17] ENTSO-E. (2017). High Penetration of Power Electronic Interfaced Power Sources (HPoPEIPS), ENTSO-E guidance document for national implementation for network codes on grid connection
- [18] ENTSO-E. (2018). Need for synthetic inertia (SI) for frequency regulation, ENTSO-E guidance document for national implementation for network codes on grid connection

- [19] ENTSO-E. (2020). Inertia and Rate of Change of Frequency (RoCoF), Version 17, SPD - Inertia TF
- [20] ENTSO-E. (2017). Fault current contribution from PPMS & HVDC, Draft of expert group FFCI
- [21] ENTSO-E. (2016). Reactive power control modes for PPM & HVDC ENTSO-E guidance document for national implementation for network codes on grid connection
- [22] IEEE. (2014). IEEE Guide for Identification, Testing and Evaluation of the Dynamic Performance of Excitation Control Systems
- [23] P.Kundur. (1994). Power System Stability and Control
- [24] KEMA DNV. (2013). Technical Report on ENTSO-E Network Code: Requirements for Generators
- [25] ENTSO-E. (2016). Reactive power management at T-D interface. ENTSO-E guidance document for national implementation for network codes on grid connection
- [26] Sandia National Laboratories. (2012). Reactive Power Interconnection Requirements for PV and Wind Plants - Recommendations to NERC
- [27] ENTSO-E. (2016). Instrumentation, simulation models and protection. ENTSO-E guidance document for national implementation for network codes on grid connection
- [28] ENERGINET.(2020).APPEDNI X 1.B - REQUIREMETNS FOR GENERATORS (RFG) REQUIREMETNS FOR SIMULATION MODELS
- [29] NETWORK CODE FOR REQUIREMENTS FOR GRID CONNECTION APPLICABLE TO ALL GENERATORS REQUIREMENTS IN THE CONTEXT OF PRESENT PRACTICES, 26.06.2012, WORKING DOCUMENT
- [30] ENTSO-E Rate of Change of Frequency (RoCoF) withstand capability ENTSO-E guidance document for national implementation for network codes on grid connection, 31 January 2018
- [31] Inertia and Rate of Change of Frequency (RoCoF) Version 17, SPD - Inertia TF 16. Dec. 2020
- [32] Frequency Stability Evaluation Criteria for the Synchronous Zone of Continental Europe - Requirements and impacting factors -RG-CE
- [33] System Protection & Dynamics Sub Group March 2016
- [34] Energy Networks Association Loss of Mains Protection Settings for all Small Generators Stakeholder Workshop 15 June 2018, London
- [35] SOGL
- [36] UCTE document "LOAD-FREQUENCY CONTROL AND PERFORMANCE, APPENDIX 1", version 1.9, level E, dated 16.06.2004.
- [37] Frequency Sensitive Mode, ENTSO-E guidance document for national implementation for network codes on grid connection", dated 31 January 2018
- [38] Entso-E Annual load - frequency report, 2019.
- [39] Limited frequency sensitive mode, ENTSO-E guidance document for national implementation for network codes on grid connection, dated on 31 January 2018
- [40] Maximum Admissible active power reduction at low frequencies, ENTSO-E guidance document for national implementation for network codes on grid connection, 31 January 2018
- [41] "Automatic connection/reconnection and admissible rate of change of active power",
- [42] ENTSO-E guidance document for national implementation of conditions for automatic connection / reconnection after incidental disconnection and admissible rate of change of active power, 31 January 2018
- [43] "Parameters related to frequency stability", ENTSO-E guidance document for national implementation for network codes on grid connection, 16 November 2016
- [44] Post-fault active power recovery, ENTSO-E guidance document for national implementation for network codes on grid connection, dated 16 November 2016.
- [45] ENTSO-E. (2010). Technical Background and Recommendations for Defence Plans in the Continental Europe Synchronous Area - LVDD schema
- [46] EirGrid's proposal for the general application of technical requirements in accordance with Articles 12 – 21 & Articles 27 – 30 of the Commission Regulation (EU) 2016/1388 establishing a Network Code on Demand Connection, 20 September 2018

- [47] PHLG-EnC. (2018). REGULATION (EU) 2016/631 of 14 April 2016 ESTABLISHING A NETWORK CODE ON REQUIREMENTS FOR GRID CONNECTION OF GENERATORS, Incorporated and adapted by Permanent High Level Group Decision 2018/03/PHLG-EnC of 12 January 2018
- [48] PHLG-EnC. (2018). COMMISSION REGULATION (EU) 2016/1388 of 17 August 2016 ESTABLISHING A NETWORK CODE ON DEMAND CONNECTION Incorporated and adapted by Permanent High Level Group Decision 2018/05/PHLG-EnC of 12 January 2018